

EFC-D203

工控整机

USER' Manual V1.1

USER'S MANUAL 用户手册

声明

本使用说明书内容如有变更，恕不另行通知。本公司并不对本使用说明书之适用性，适合做某种特殊用途之使用或其他任何事项做任何明示，或做其他形式之保证或担保。因此本公司将不对手册内容之错误，或因增减展示或以其他方式使用本手册所造成之直接，间接，突发性过、或继发性之损害负任何责任。

版权声明：

版权所有-----深圳智锐通科技有限公司。未经本公司许可或依著作权法之规定许准，不得复制，节录和翻译使用说明书之任何内容。

安全须知

1	产品使用前，务必仔细阅读产品说明书。
2	对未准备安装的板卡，应将其保存在防静电保护袋中。
3	在从包装袋中拿板卡前，应将手先置于接地金属物体上一会儿，以释放身体及手中的静电。
4	在拿板卡时，需佩带静电保护手套，并且应该养成只触及边缘部份的习惯。
5	主板与电源连接时，请确认电源电压。
6	为避免人本被电击或产品被损坏，在每次对主板、板卡进行拔插或生新配置时须先关闭交流电源或将交流电源线从电源插座中拔掉。
7	在对板卡进行搬动前，先将交流电源线从电源插座中拔掉。
8	当您需连接或拔除任何设备前，须确定所有的电源线事先已被拔掉。
9	为避免频繁开关机对产品造成不必要的损伤,关机后,应至少等待30秒后再开机。
10	设备在使用过程时出现异常情况，请找专业人员处理。

目录

第一章 产品介绍.....	6
1.1 产品规格.....	6
1.2 驱动.....	8
1.3 功能框图.....	8
1.4 产品料号.....	8
1.4 产品照片.....	9
第二章 安装说明.....	10
2.1 接口/尺寸图.....	10
2.2 插针引脚定义.....	11
2.2.1 串行通讯口.....	11
第三章 BIOS 程序设置.....	12
3.1 Main Screen.....	13
3.2 Advanced Screen.....	15
3.2.1 CPU Configuration Screen.....	16
3.2.2 ACPI Settings Screen.....	19
3.2.3 Super IO Configuration.....	20
3.2.3.1 Serial PortX Configuration.....	21
3.2.4 Hardware Monitor.....	22
3.2.5 SATA Configuration.....	24
3.2.6 USB Configuration.....	25
3.2.7 CSM Configuration.....	27
3.2.8 NVMe Configuration.....	29

3.2.9 Watchdog Configuration	30
3.2.10 PXE Boot	31
3.3 Chipset Screen	32
3.3.1 System Agent (SA) Configuration.....	33
3.3.2 PCH-IO Configuration	36
3.4 Security.....	37
3.5 Boot Screen.....	38
3.6 Save & Exit Screen.....	39
附录.....	41
附一：术语表.....	41

第一章 产品介绍

1.1 产品规格

Model		EFC-D203			
配置 Item	规格 Specification	描述 Describe			
处理器 Processor System	CPU	Intel 6/7 th Skylake / Kaby Lake-U i3/i5/i7			
	处理器 CPU	I3-6100U	I5-6200U	I7-7500U	3955U
	内核数 Core Number	2	2	2	2
	基本主频 Base Frequency	2.30GHz	2.30GHz	2.70GHz	2.0GHz
	最高主频 Max. Speed		2.80GHz	3.50GHz	
	二级缓存 L2 Cache	3M	3M	4M	2M
	功耗 TDP (W)	15W	15W	15W	15W
	BIOS	AMI 64MBit SPI			
内存 Memory	规格 Technology	DDR4 2333MHz			
	最大容量 Max. Capacity	32GB			
	插槽 Socket	1 x SO-DIMM			
扩展插槽 Expansion Slot	M.2	1 x M.2 M-Key(2280)for NVME/SATA 1 x M.2 B-Key(2260)for 4G/5G			
	SIM	1 x SIM			
存储 Storage	SATA	1 x SATA3.0 SATA 6Gb/s			
USB / Type-C	前面板 Front I/O	3 x USB2.0			
	后面板 Rear I/O	2 x USB3.0 2 x USB2.0			
串口 COM	前面板 Front I/O	1 x RS232/RS485/RS422			
	后面板 Rear I/O	1 x RS232/RS485/RS422			

显示 Graphics	最多显示 Multiple Display	1 Port
	后面板 Rear I/O	1 x HDMI1.4a
	分辨率 Resolution	HDMI1.4a:4096*2304@24Hz
以太网 Ethernet	控制器 Controller	Intel® Ethernet Controller I211-AT
	前面板 Front I/O	1 x RJ45 10/100/1000M
	后面板 Rear I/O	3 x RJ45 10/100/1000M
音频 Audio	芯片 Chipset	Integrated High Definition Audio Stereo (ALC897)
	I/O	1 x Audio + MIC
其它 Others	按钮 Button	1 x Power Button
	看门狗 Watch Dog	256 Level
	LPC	1 x LPC
电源 Power Requirements	电源类型 Power Type	DC In(φ5.5)
	电源功耗 Consumption	60W
	电源电压 Input Voltage	9~36V, Max 5A
物理特性 Physical	尺寸 Dimensions	170.3*129.4*84.2mm
	PCB 颜色 Color	Gray
环境 Environment	工作温度 Operating Temperature	0~60°C
	存储温度 Storage Temperature	-40~85°C
	工作湿度 Operating Humidity	10~90%RH(non-condensing)
操作系统 OS	Microsoft	Windows 10 1809(RS5)
	Linux	Yocto 2.4 Rocko

1.2 驱动

Windows 10: https://pan.baidu.com/s/14_XLZ-o1d4pwT922W3amFw?pwd=t7l6

1.3 功能框图

Block Diagram

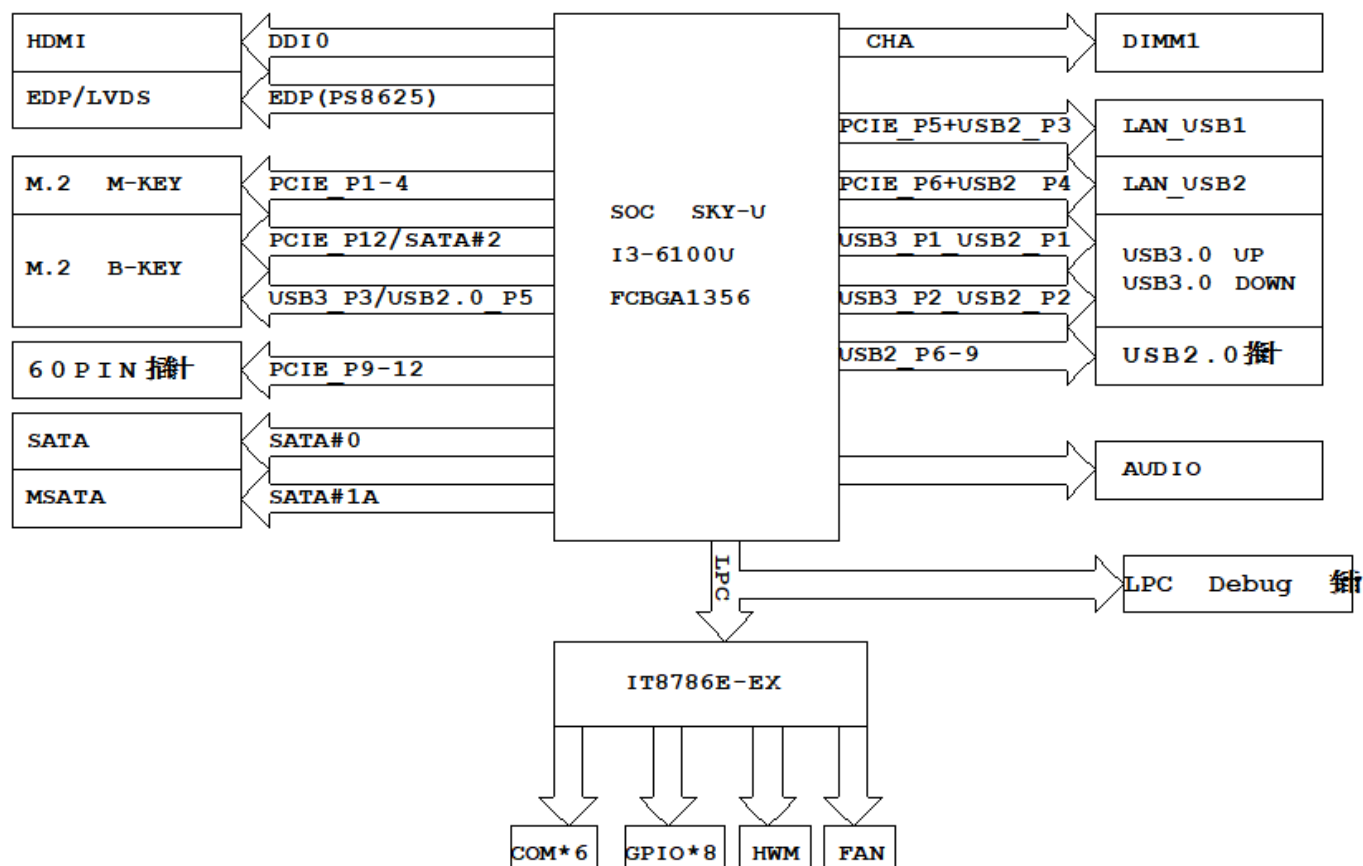

1.4 产品料号

Model	Part Number	Specification
EFC-D203-01	8.ZRT.80-6484-12-LEE	EFC-D203-01 整机 EMB-3201 主板 V1.0/4 网口 /8GB+512G /一体式机箱散热器/电源适配器+电源线 /线材/包装/转接卡 版本 A00

1.5 产品照片

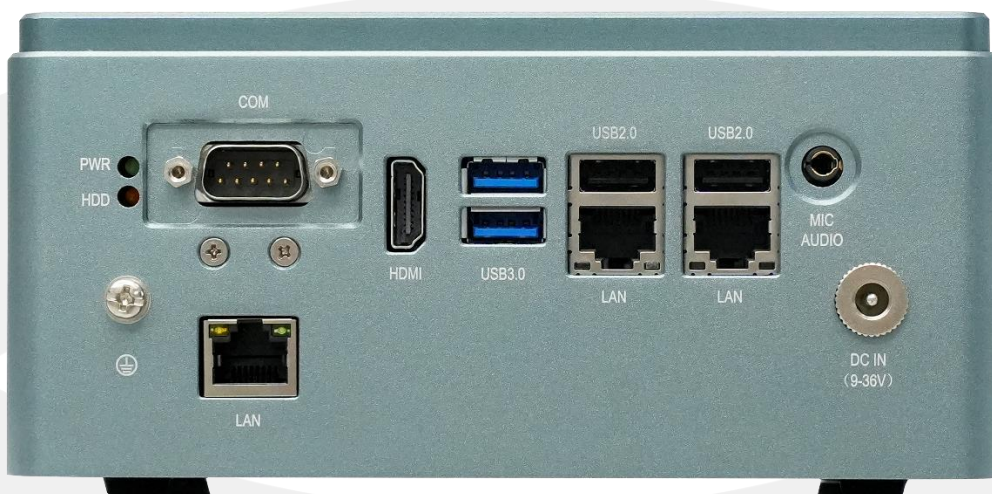

第二章 安装说明

2.1 接口/尺寸图

安装设备时, 请对照此示意图并仔细阅读下面的说明, 安装组件过程中必须小心, 对于有些部件, 如果安装不正确, 设备将不能正常工作。

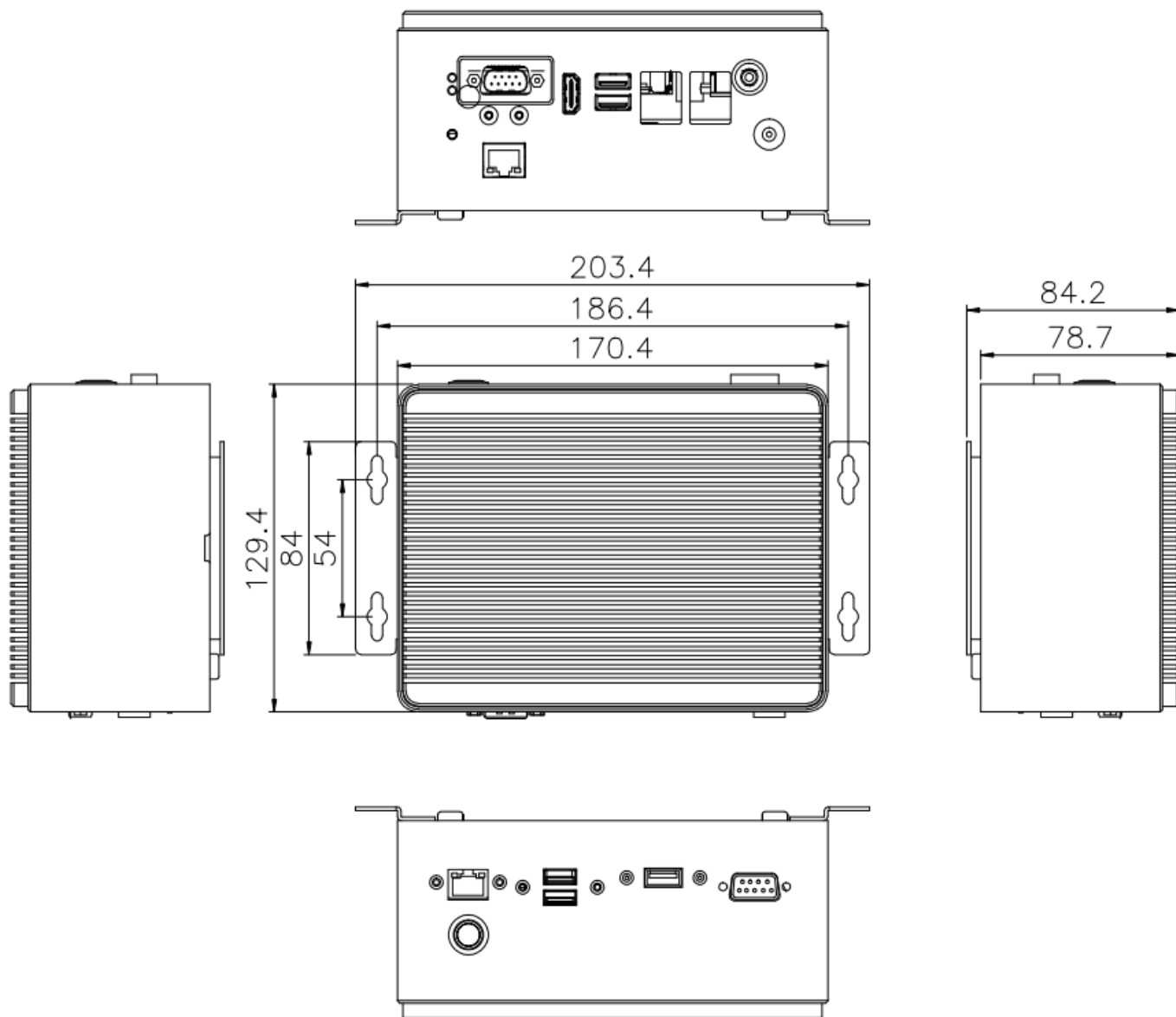

2.2 插针引脚定义

2.2.1 串行通讯口

RS232/RS485/RS422 复合功能串口, DB9 接口, 位置: COM1:

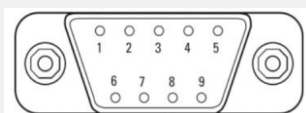

管脚	信号名称		
	RS-232	RS-422	RS-485
1	DCD#	TXD-	Data-
2	RXD	TXD+	Data+
3	TXD	RXD+	NC
4	DTR#	RXD-	NC
5	GND	GND	GND
6	DSR#	NC	NC
7	RTS#	NC	NC
8	CTS#	NC	NC
9	RI#	NC	NC
10	NA	NA	NA

第三章 BIOS 程序设置

AMI BIOS 刷新

BIOS 提供对硬件资源的底层驱动，是联系硬件和操作系统的桥梁。现在硬件和各种应用软件不断更新，当您的系统遇到问题时，例如系统不支持最新公布的 CPU 时，就需要升级您的 BIOS 了。

注意：

1. **升级 BIOS 只在遇到问题，必要的时候进行。**
2. **升级 BIOS 请使用我们驱动光盘内所附的 BIOS 读写程序，或者在相关网站下载更新版本的程序。**
3. **在升级过程中不要关闭电源或重新启动系统，以免造成您的 BIOS 资料将被损坏，系统也可能不能启动。**
4. **为防止意外发生，请您先备份当前的 BIOS 资料。**

AMI BIOS 描述

开机时，BIOS 会对主板上的硬件进行自我诊断，设定硬件时序参数等工作，最后才将系统控制权交给操作系统。如何正确的设定 BIOS 参数对系统是否稳定的工作及系统是否工作在最佳状态至关重要。

进入 BIOS 参数设置：

电脑开机，在完成自我诊断后，屏幕上会显示出如下信息：Del->SETUP，此时您点击一下 Del 键，则 BIOS 在完成 IDE 等设备的侦测后会自动转入 SETUP 设置画面。

1. 打开系统电源或重新启动系统，显示器屏幕将出现自我测试的信息：
2. 当屏幕中间出现“Pressto enter setup”提示时，按下键，就可以进入 BIOS 设定程序。
3. 以方向键移动至您要修改的选项，按下<Enter>键即可进入该选项的子画面。
4. 使用方向键及<Enter>键即可修改所选项目的值，按回车键选择 BIOS 选项并修改。
5. 任何时候按下<Esc>键即可回到上一画面。

Setup Utility User Interface

This document describes BIOS Setup Utility user interface.

3.1 Main Screen

The Main screen is the first screen that is displayed when the BIOS Setup is entered.

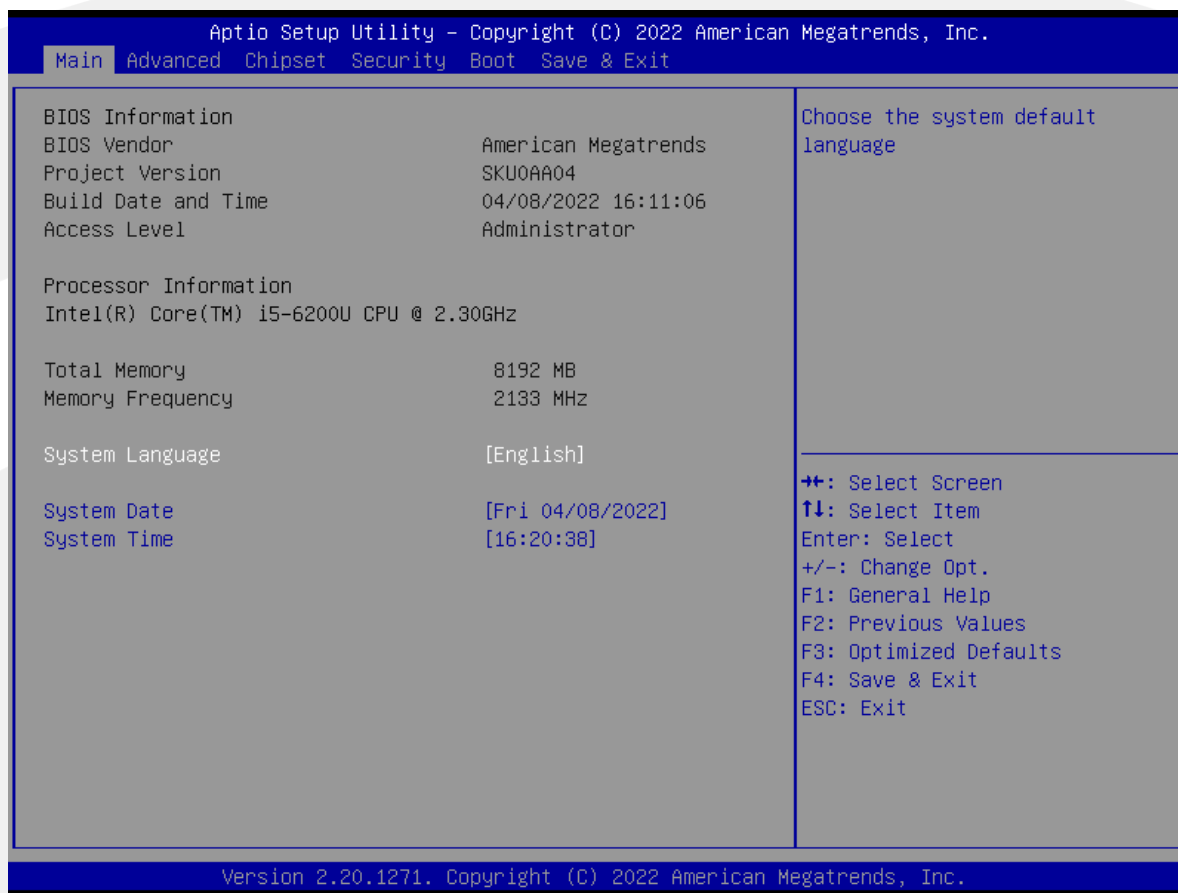

Setup Item	Options	Help Text	Comments
BIOS Information			
BIOS Vendor			Displays BIOS vendor.
Project Version			Displays the current BIOS version: Format: AAAABBC AAAAA = Project name BB = BIOS revision C = Customer number
Build Date and Time			Displays the current BIOS build date.
Access Level			Displays password level that setup is running in: Administrator or User. With no passwords set, Administrator is the default mode.

Setup Item	Options	Help Text	Comments
Processor Information			
CPU XXXXX			Displays the CPU BrandString installed in the system.
Memory Information			
Total Memory			Displays the total physical memory installed in the system, MB Unit.
Memory Frequency			
System Language	English	Choose the system default language.	
System Date	[Day of week MM/DD/YYYY]	Set and display the Date.	
System Time	[HH:MM:SS]	Set and display the Time.	

3.2 Advanced Screen

The Advanced screen provides an access point to configure several options. On this screen, the user selects the option that is to be configured.

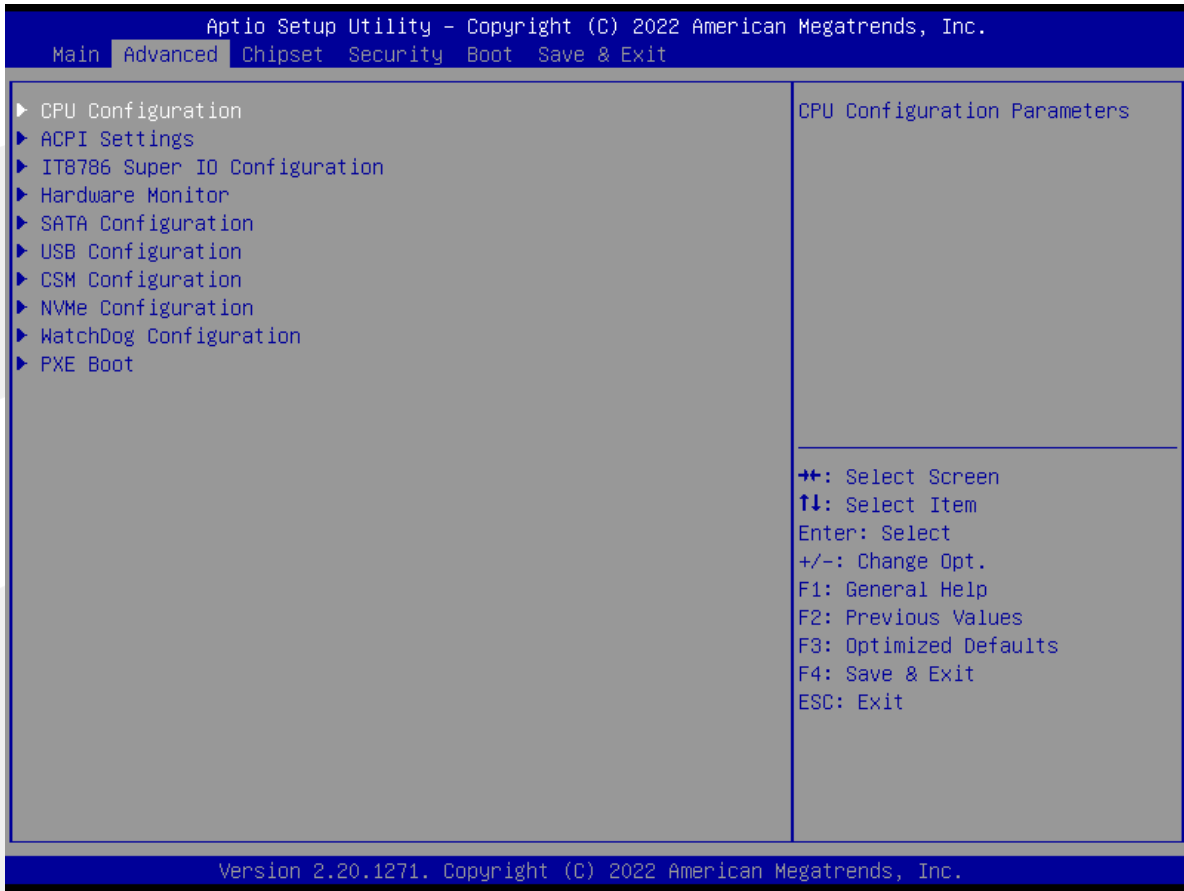

Setup Item	Options	Help Text	Comments
CPU Configuration		CPU Configuration Parameters.	
ACPI Settings		System ACPI Parameters.	
Super IO Configuration		System Super IO chip Parameters.	
H/W Monitor		Monitor hardware stats.	
SATA Configuration		SATA Devices Configuration.	
USB Configuration		USB Configuration Parameters.	
CSM Configuration		CSM configuration: Enable/Disable, Option ROM execution settings, etc.	
NVMe Configuration		NVMe Device Options Settings.	
Watchdog configuration		Set System WatchDog Parameters.	
PXE Boot		Legacy PXE Support Control.	

3.2.1 CPU Configuration Screen

The CPU Configuration screen allows the user to view the processor information, and to enable or disable processor options. To access this screen from the Main screen, choose **Advanced > CPU Configuration**.

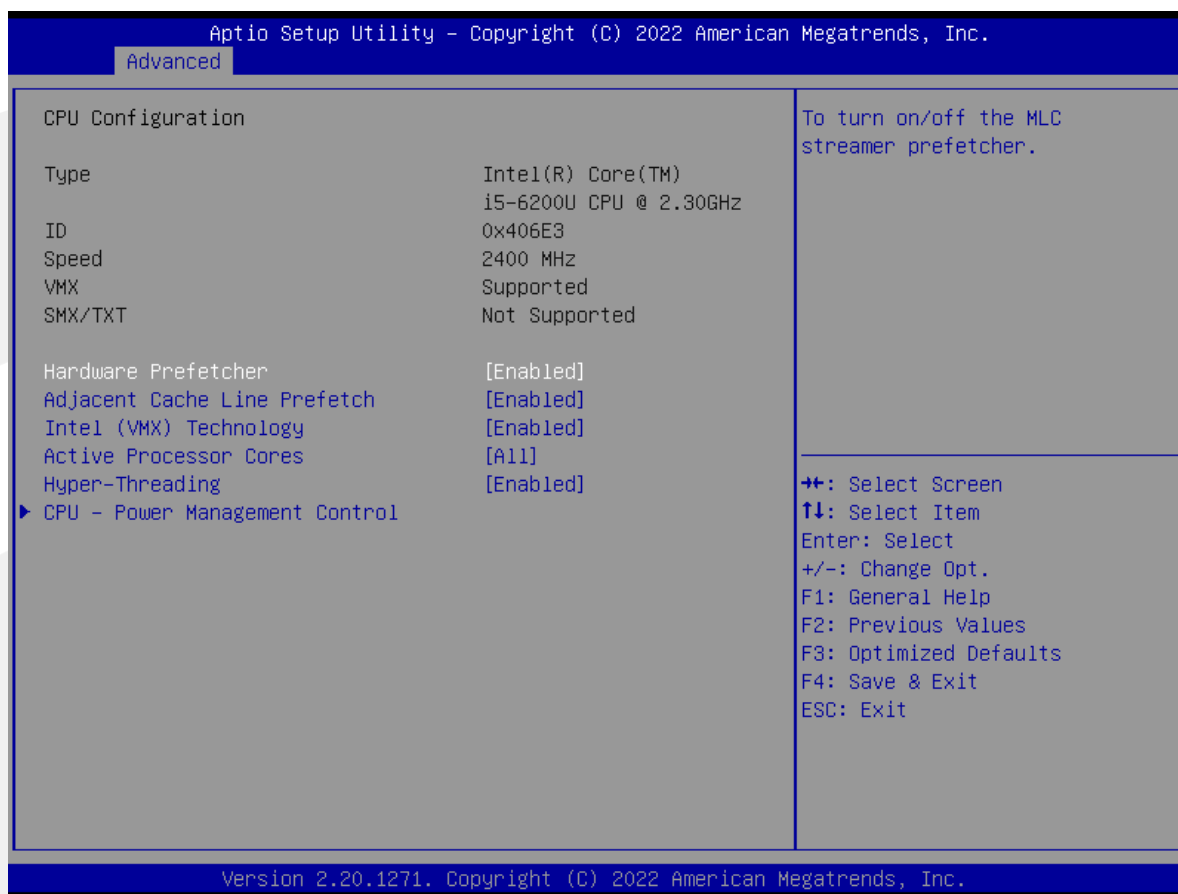

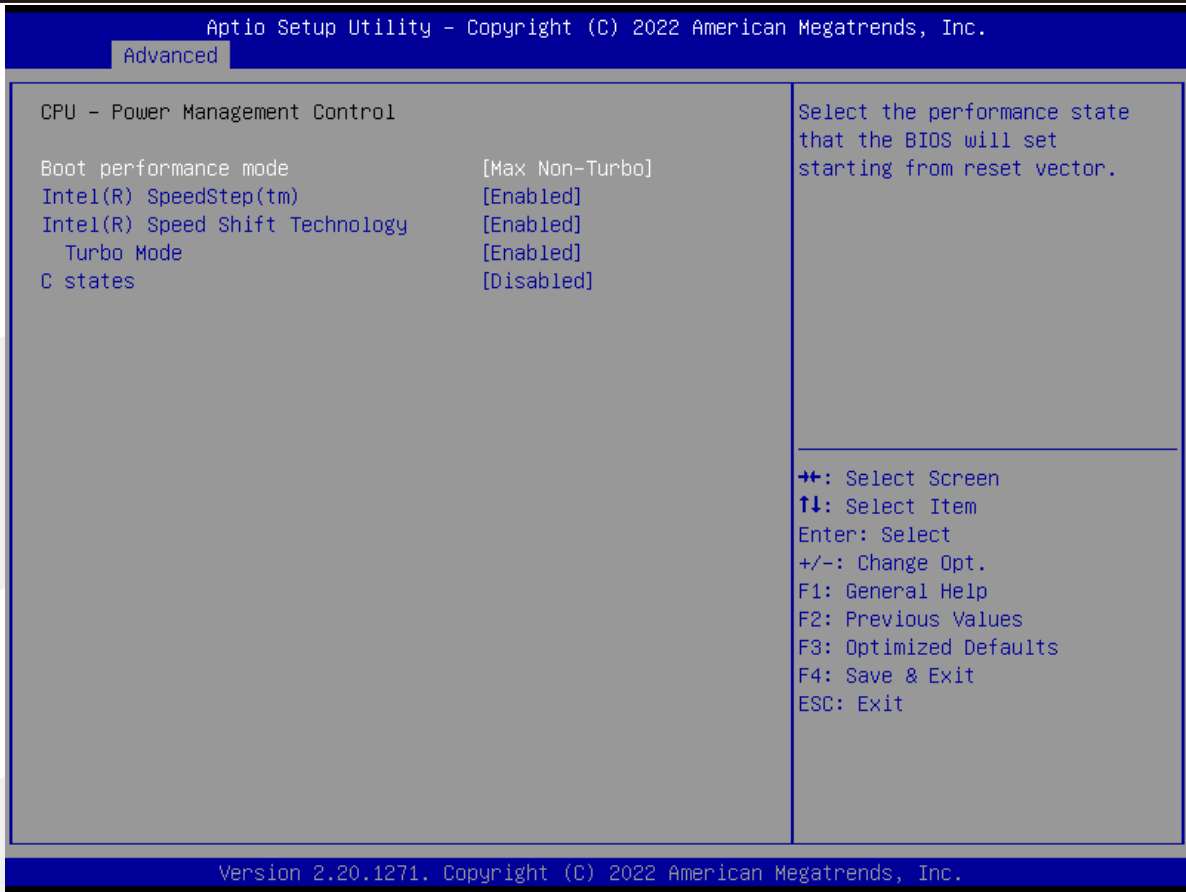

Setup Item	Options	Help Text	Comments
CPU Configuration			
Type			
ID			
Speed			
VMX			
SMX/TXT			
Hardware Prefetcher	Enabled Disabled	To turn on/off the MLC streamer prefetcher.	
Adjacent Cache line Prefetch	Enabled Disabled	To turn on/off prefetching of adjacent cache lines.	
Intel(VMX) Virtualization Technology	Enabled Disabled	When enabled,a VMM can utilize the additional hardware capabilities provided by Vanderpool technology.	
Active Processor Cores	All 1 2 3	Number of cores to enable in each processor package.	
Hyper-Threading	Enabled		

Setup Item	Options	Help Text	Comments
CPU Power Management Control			
Boot performance mode	Max Non-Turbo Max battery Turbo Performance	Select the performance state that the BIOS will set starting from reset vector.	
Intel® SpeedStep™	Enabled Disabled	Allows more than two frequency ranges to be supported.	
Intel® Speed Shift Technology	Enabled Disabled	Enable/Disable Intel® speed shift technology support.	
Turbo Mode	Enabled		
C states	Enabled Disabled	Enable/Disable CPU Power Management. Allows CPU to go to Cstates when it' s not 100% utilized.	

3.2.2 ACPI Settings Screen

The ACPI Settings screen allows the user to set the system ACPI parameters. To access this screen from the Main screen, choose **Advanced > ACPI Settings**.



Setup Item	Options	Help Text	Comments
ACPI Settings			
ACPI Sleep State	Suspend Disabled S3 (Suspend to RAM)	Select the highest ACPI sleep state the system will enter when the SUSPEND button is pressed.	Sleep supported optionally.

3.2.3 Super IO Configuration

The Super IO Configuration screen allows the user to view the super IO information, and to enable or disable super IO options. To access this screen from the Advanced screen, choose **Advanced > Super IO Configuration**.

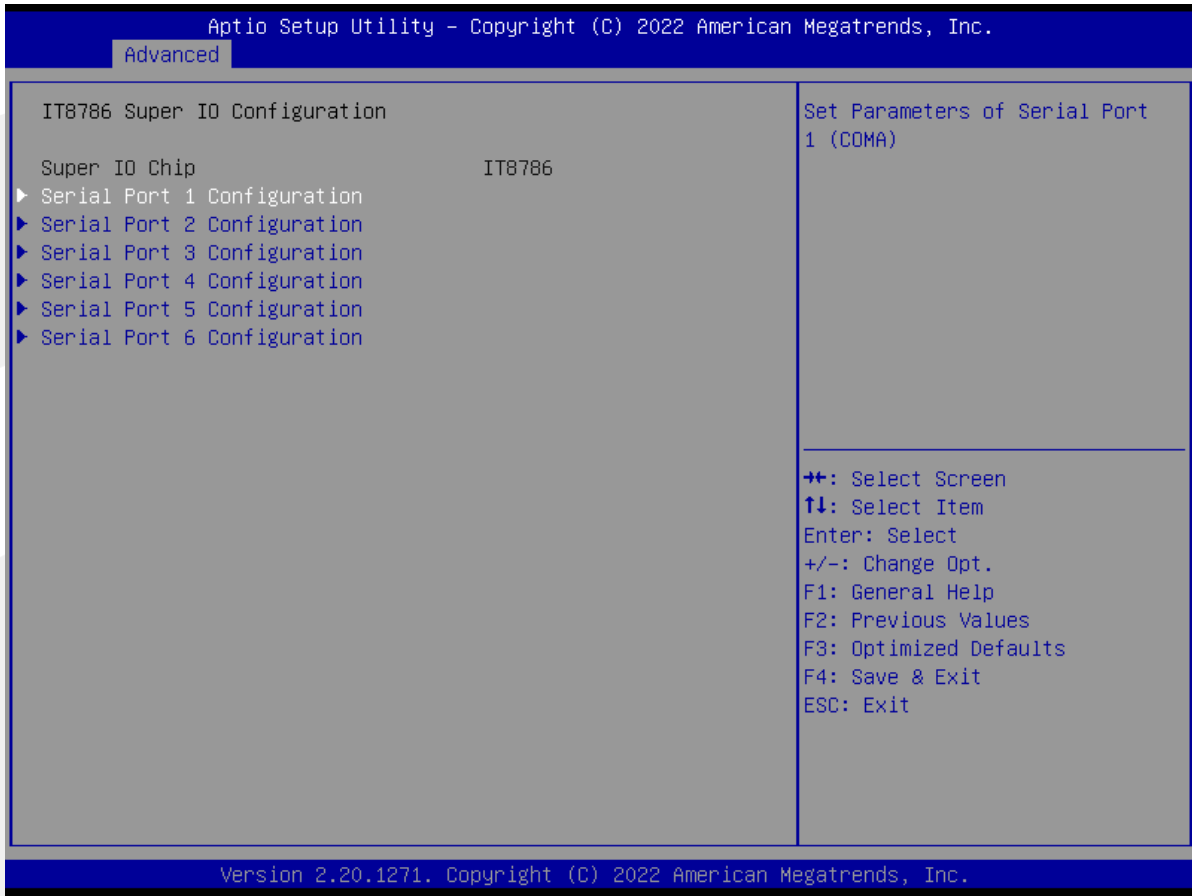

Setup Item	Options	Help Text	Comments
Super IO Configuration			
Serial Port 1 Configuration			Set Parameters of Serial Port 1 (COM1).

3.2.3.1 Serial PortX Configuration

The Super IO Configuration screen allows the user to view the super IO information, and to enable or disable serial port options. To access this screen from the Advanced screen, choose **Advanced-> Super IO Configuration->Serial PortX Configuration**.

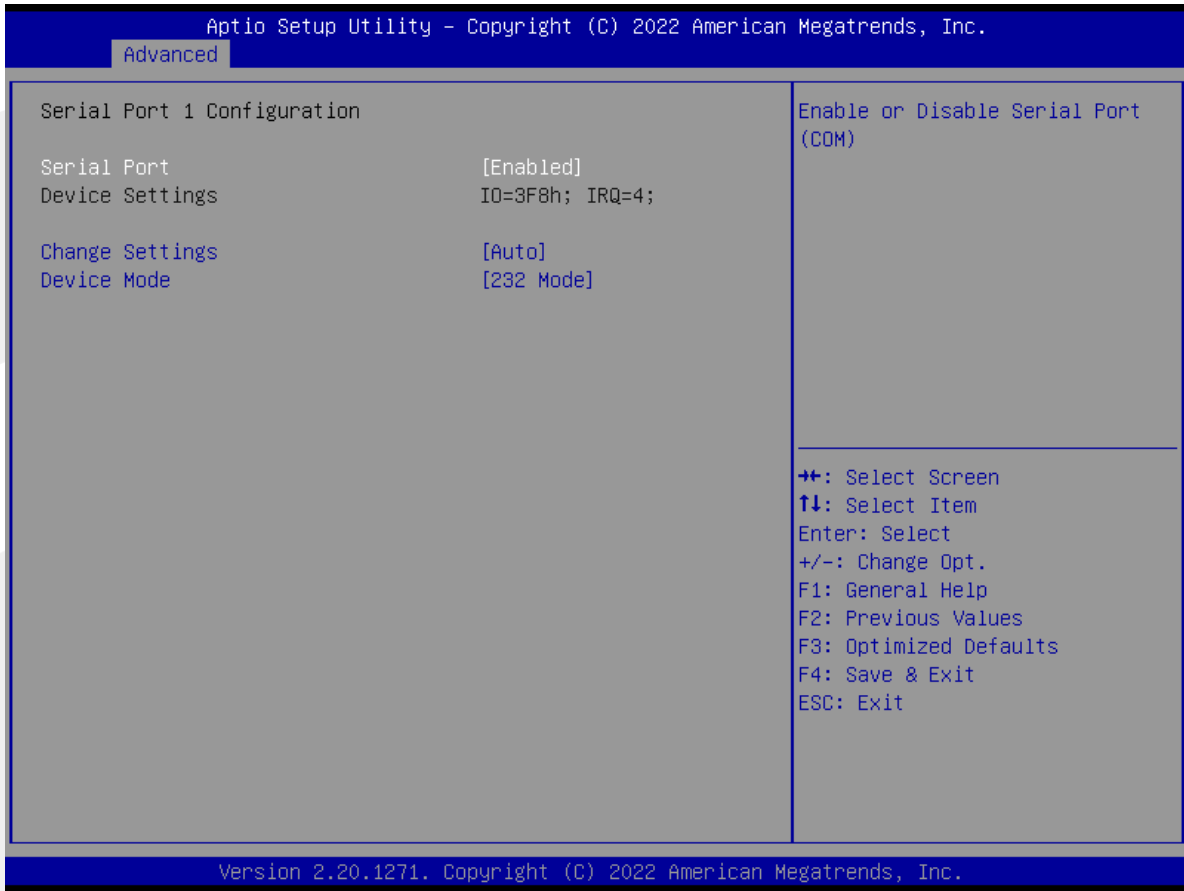

Setup Item	Options	Help Text	Comments
Serial PortX Configuration			
Serial Port	Enabled Disabled	Enable or Disable Serial Port (COM).	
Device Settings			
Change Settings	Auto IO=3F8h; IRQ=4 IO=3F8h; IRQ=3,4,5,6,7,9,10,11,12 IO=2F8h; IRQ=3,4,5,6,7,9,10,11,12 IO=3E8h; IRQ=3,4,5,6,7,9,10,11,12 IO=2E8h; IRQ=3,4,5,6,7,9,10,11,12	Select an optimal settings for Super IO Device.	
Device Mode			

3.2.4 Hardware Monitor

The hardware monitor screen allows the user to view the hardware information. To access this screen from the Advanced screen, choose **Advanced-> Hardware Monitor**.

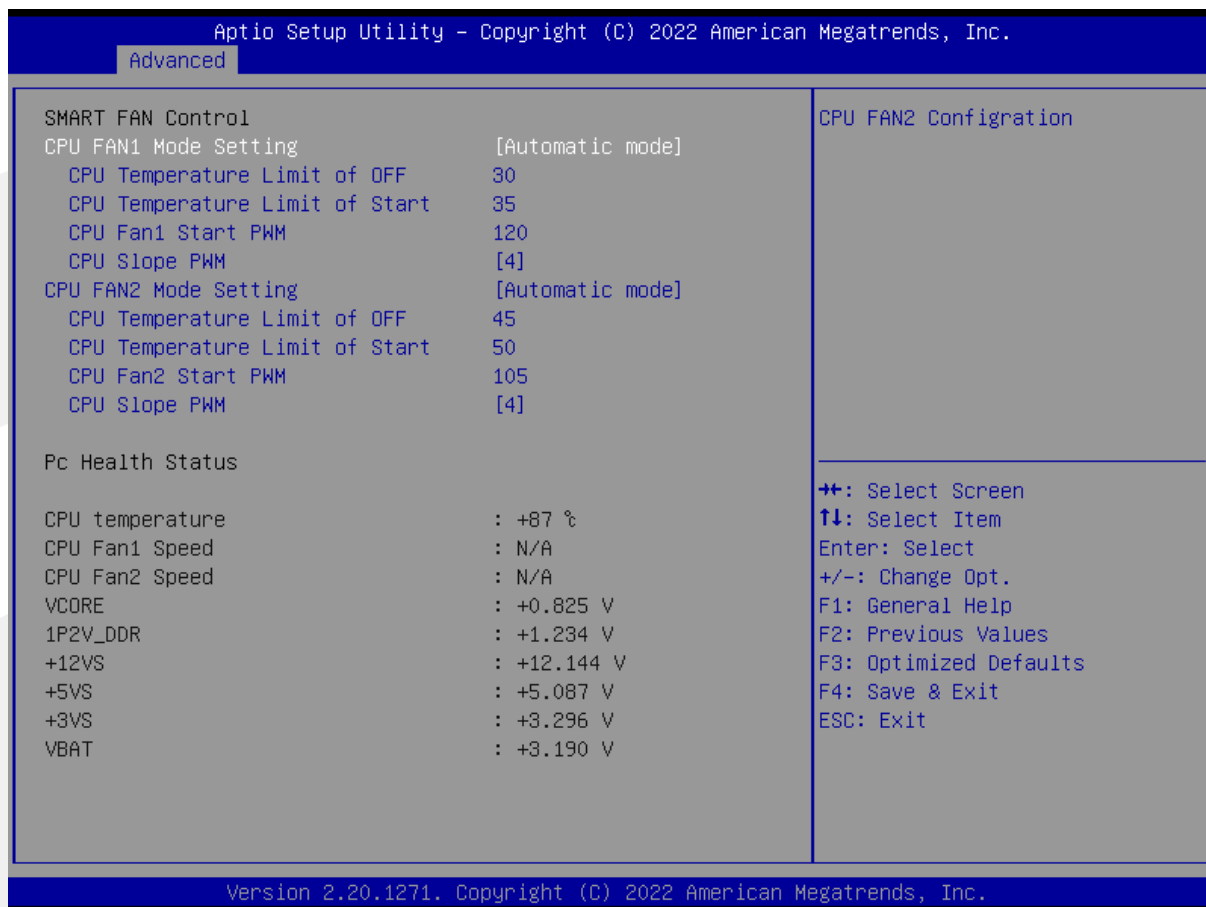

Setup Item	Options	Help Text	Comments
Hardware Monitor			
SMART FAN Control			
CPU Fan1 Mode Setting	Automatic mode Manual mode	CPU Fan control mode select.	When Manual mode selected, Manual PWM Setting shows to set FAN PWM Duty.
CPU Fan2 Mode Setting	Automatic mode Manual mode	SYS Fan control mode select.	When Manual mode selected, Manual PWM Setting shows to set FAN PWM Duty.
PC Health Status			
CPU temperature		Shows Current CPU temperature.	NOTE1: Sometimes not the actual temperature value, just indicates temperature tolerance limitation.

Setup Item	Options	Help Text	Comments
CPU Fan1 Speed			HW Information.
CPU Fan2 Speed			
VCORE			
1P2V_DDR			
+12VCS			
+5VCS			
+3VCS			
VBAT			

3.2.5 SATA Configuration

The SATA Configuration screen allows the user to view the SATA Controller information, and to enable or disable SATA Controller options. To access this screen from the Main screen, choose **Advanced > SATA Configuration**.

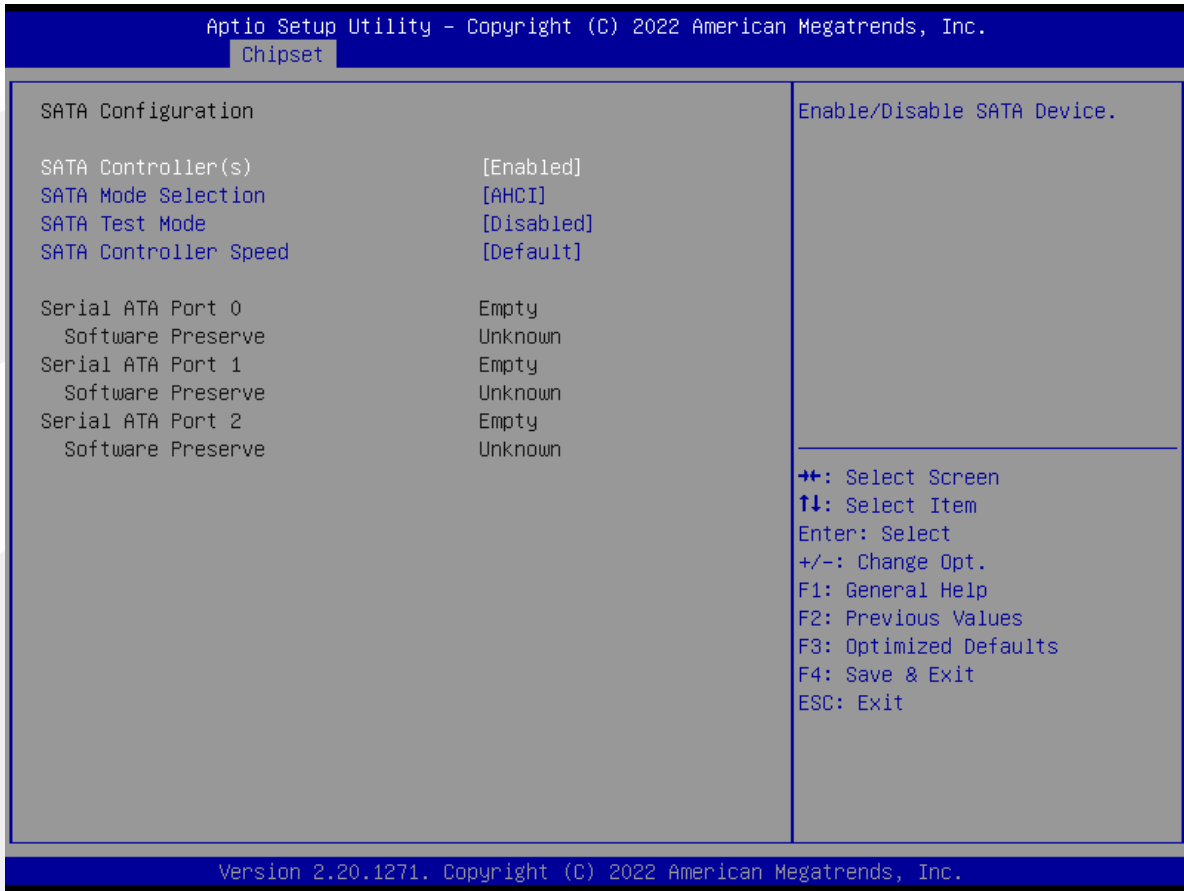

Setup Item	Options	Help Text	Comments
SATA Configuration			
SATA Controller(s)	Enabled Disabled	Enable / Disable SATA Device.	
SATA Mode Selection	AHCI Mode	Select AHCI.	
SATA Test Mode	Disabled		
SATA Controller Speed	Default Gen1 Gen2 Gen3	SATA port speed settings.	
Serial ATA Port 0			Show HDD information connected.
Serial ATA Port 1			
Serial ATA Port 2			

3.2.6 USB Configuration

The USB Configuration screen allows the user to view the USB Configuration information, and to enable or disable options. To access this screen from the Main screen, choose **Advanced > USB Configuration**.

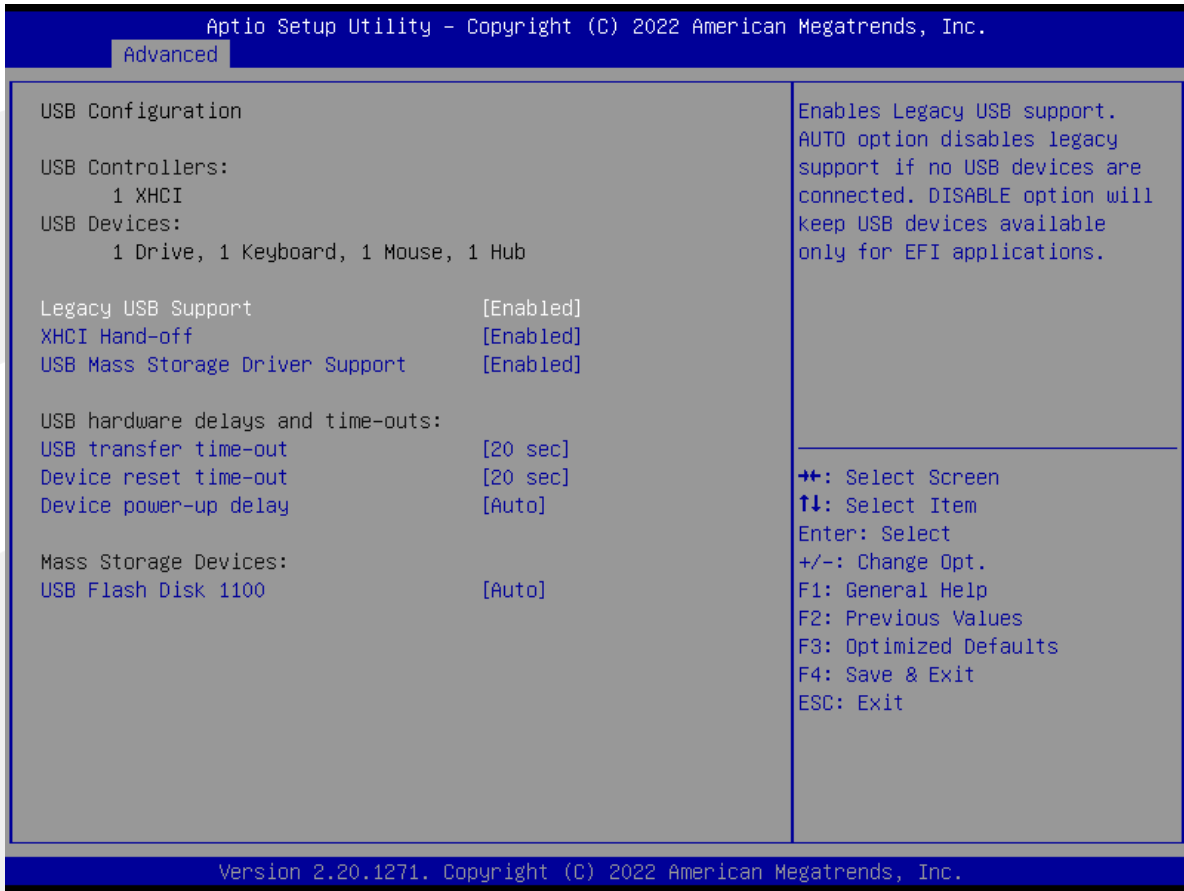

Setup Item	Options	Help Text	Comments
USB Configuration			
Legacy USB Support	Enabled Disabled	Enables Legacy USB support. AUTO option disables legacy support if no USB devices are connected. DISABLE option will keep USB devices available only for EFI applications.	
XHCI Hand-off	Enabled Disabled	This is a workaround for OSEs without XHCI hand-off support. The XHCI ownership change should be claimed by XHCI driver.	
USB MASS Storage Driver Support	Enabled Disabled	Enable/Disable USB Mass Storage Driver Support.	
USB hardware delays and time-outs:			
USB transfer time-out	1 sec 5 sec 10 sec 20 sec	The time-out value for Control, Bulk, and Interrupt transfers.	

Setup Item	Options	Help Text	Comments
Device reset time-out	1 sec 5 sec 10 sec 20 sec	USB mass storage device Start Unit command time-out.	
Device power-up delay	Auto Manual	Maximum time the device will take before it properly reports itself to the Host Controller. ' auto' uses default value: for a Root port it is 100ms,for a Hub port the delay is taken from Hub descriptor.	

3.2.7 CSM Configuration

The CSM Configuration screen allows the user to view the CSM information, and to enable or disable CSM options. To access this screen from the Main screen, choose **Advanced > CSM Configuration**.

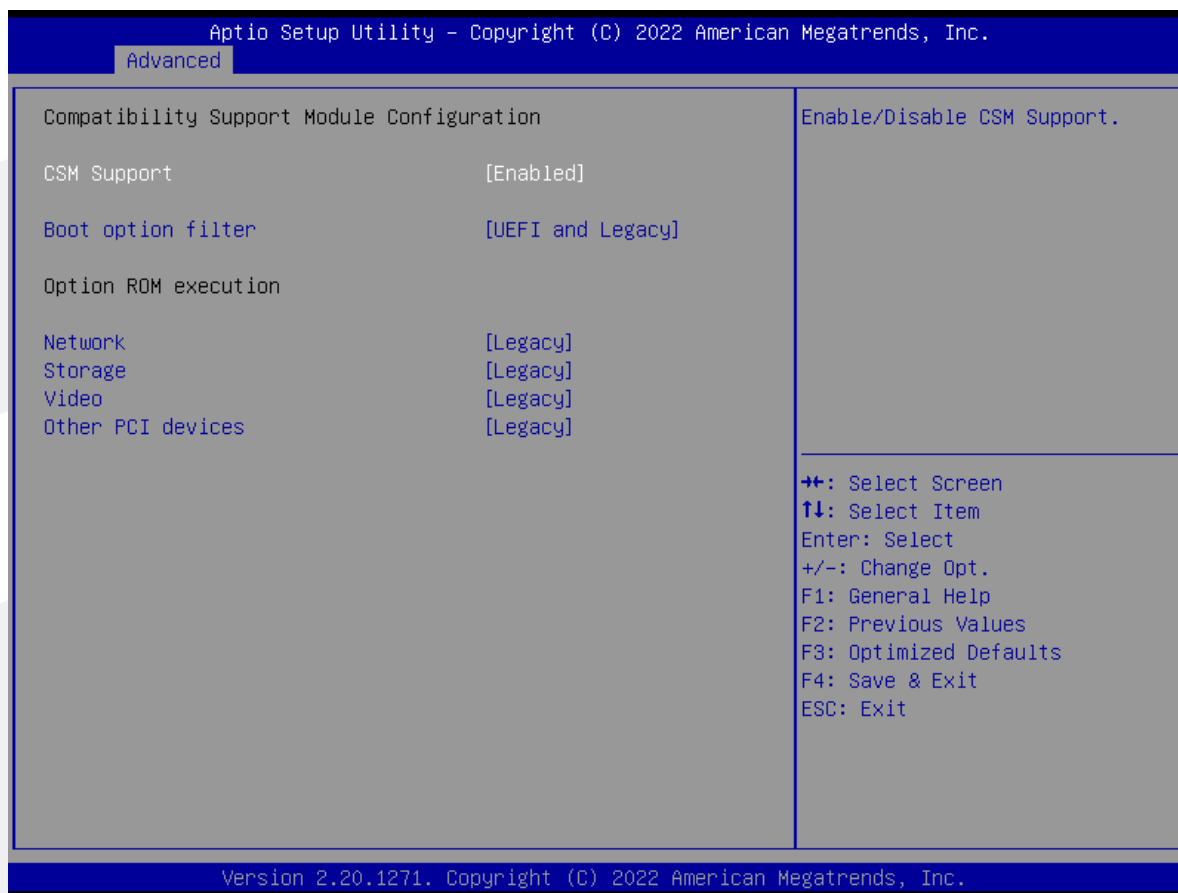

Setup Item	Options	Help Text	Comments
CSM Configuration			
CSM Support	Enabled Disabled	Enable / Disable CSM support.	
Boot option filter	UEFI and Legacy Legacy only UEFI only	This option control Legacy/UEFI ROMs priority.	
Option ROM execution			
Network	Legacy UEFI Do not lunch	Control the execution of UEFI and Legacy PXE OpROM.	
Storage	Legacy UEFI Do not lunch	Control the execution of UEFI and Legacy Storage OpROM.	
Video	Legacy UEFI Do not lunch	Control the execution of UEFI and Legacy video OpROM.	

Setup Item	Options	Help Text	Comments
Other PCI devices	Legacy UEFI Do not lunch	Determines OpROM execution policy for devices other than Network, Storage or video.	

3.2.8 NVMe Configuration

The NVMe Configuration screen allows the user to view the NVMe device information. To access this screen from the Main screen, choose **Advanced > NVMe Configuration**.

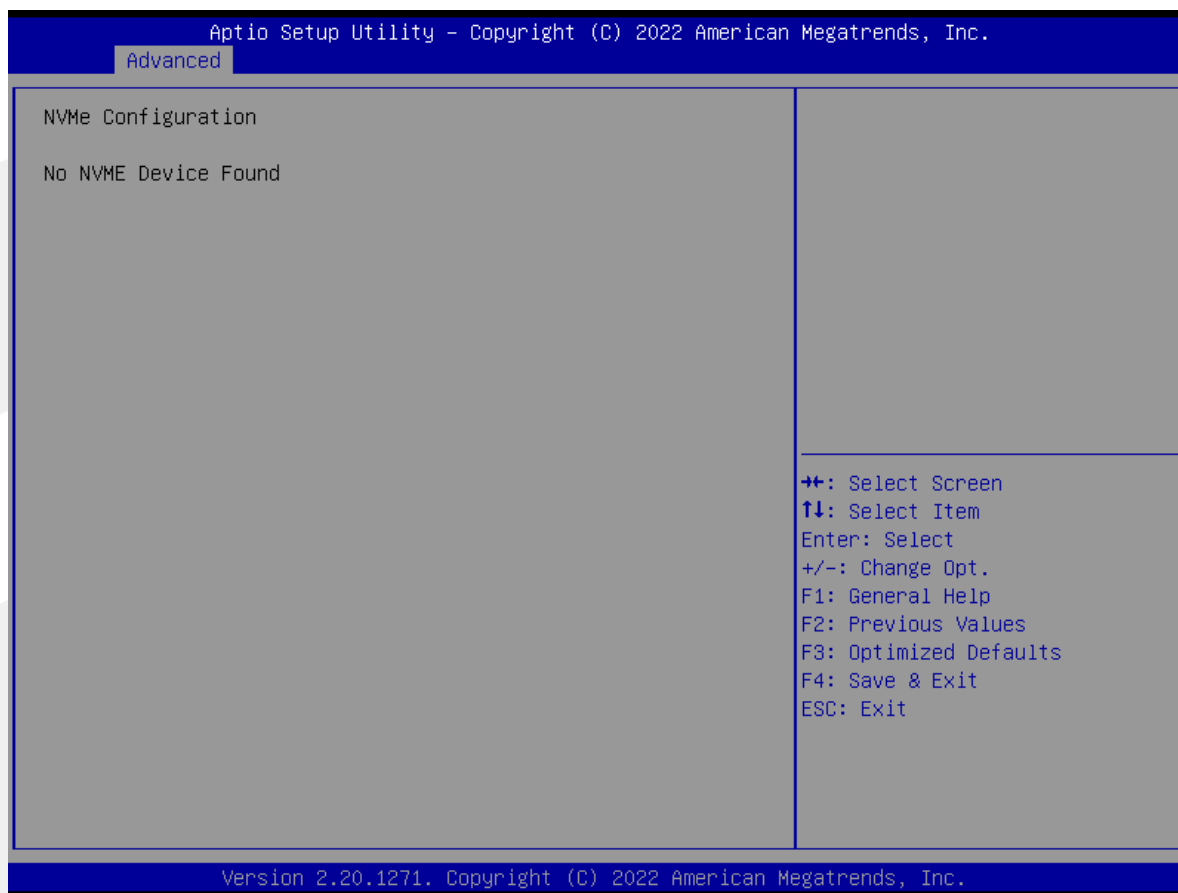

Setup Item	Options	Help Text	Comments
NVMe Configuration			
Controller 0			Show NVMe device information connected.

3.2.9 Watchdog Configuration

The Watchdog Configuration screen allows the user to Set System WatchDog Parameters. To access this screen from the Main screen, choose **Advanced > Watchdog Configuration**.



Setup Item	Options	Help Text	Comments
Watchdog Parameters			
WatchDog Control	Disabled Enabled		WatchDog function.
WatchDog Count Mode	Minute Second		WatchDog Count Mode Selection.
WatchDog TimeOut Value	1		Fill WatchDog TimeOut (0~255),0 means function disabled.

3.2.10 PXE Boot

The PXE Boot screen allows the user to Enable or Disable Boot Option for Legacy Network Devices. To access this screen from the Main screen, choose **Advanced > PXE Boot**.

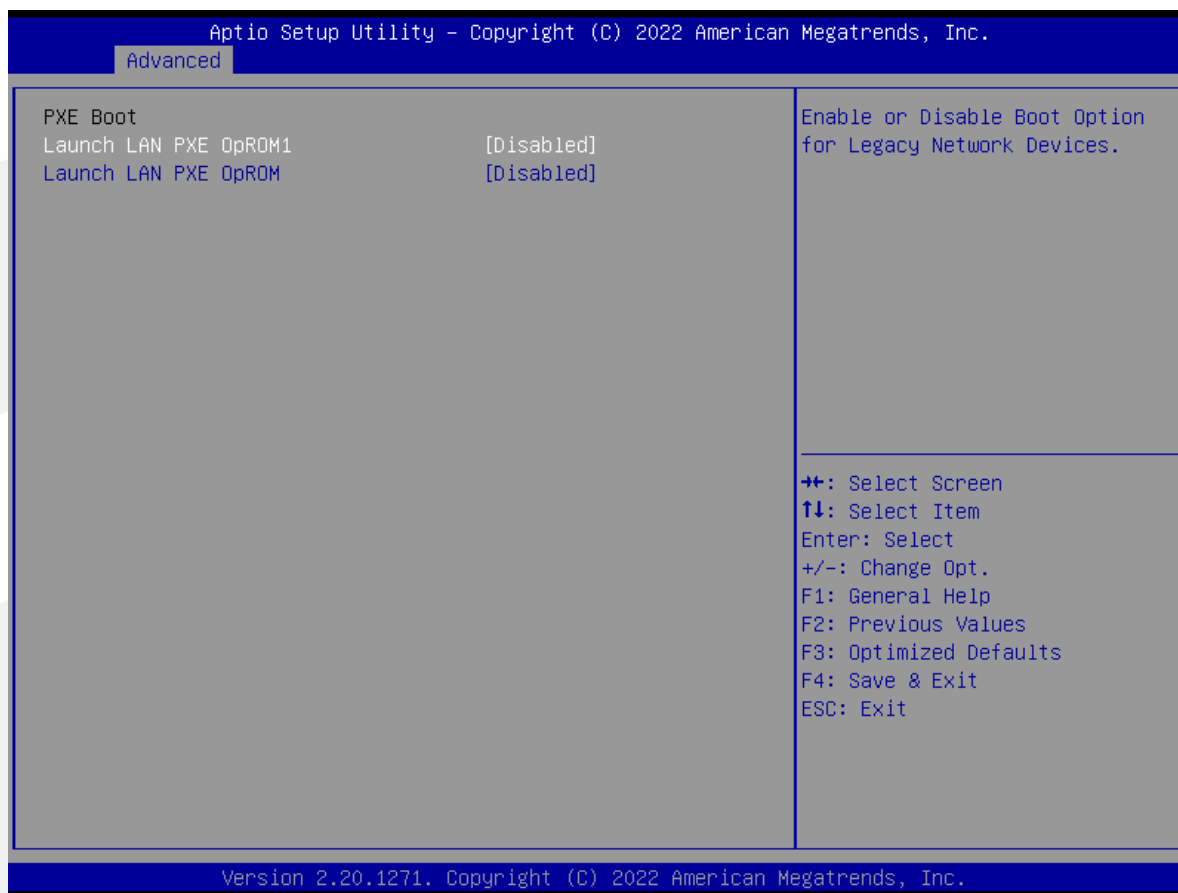

Setup Item	Options	Help Text	Comments
PXE Boot			
Launch LAN1 PXE OpROM1	Disabled Enabled		Legacy PXE Support Control.
Launch LAN1 PXE OpROM	Disabled Enabled		Legacy PXE Support Control.
LVDS Control	Disabled Enabled		LVDS control.

3.3 Chipset Screen

The Chipset screen provides an access point to configure North Bridge and South Bridge. To access this screen from the Main screen, press the right arrow until the Chipset screen is chosen.

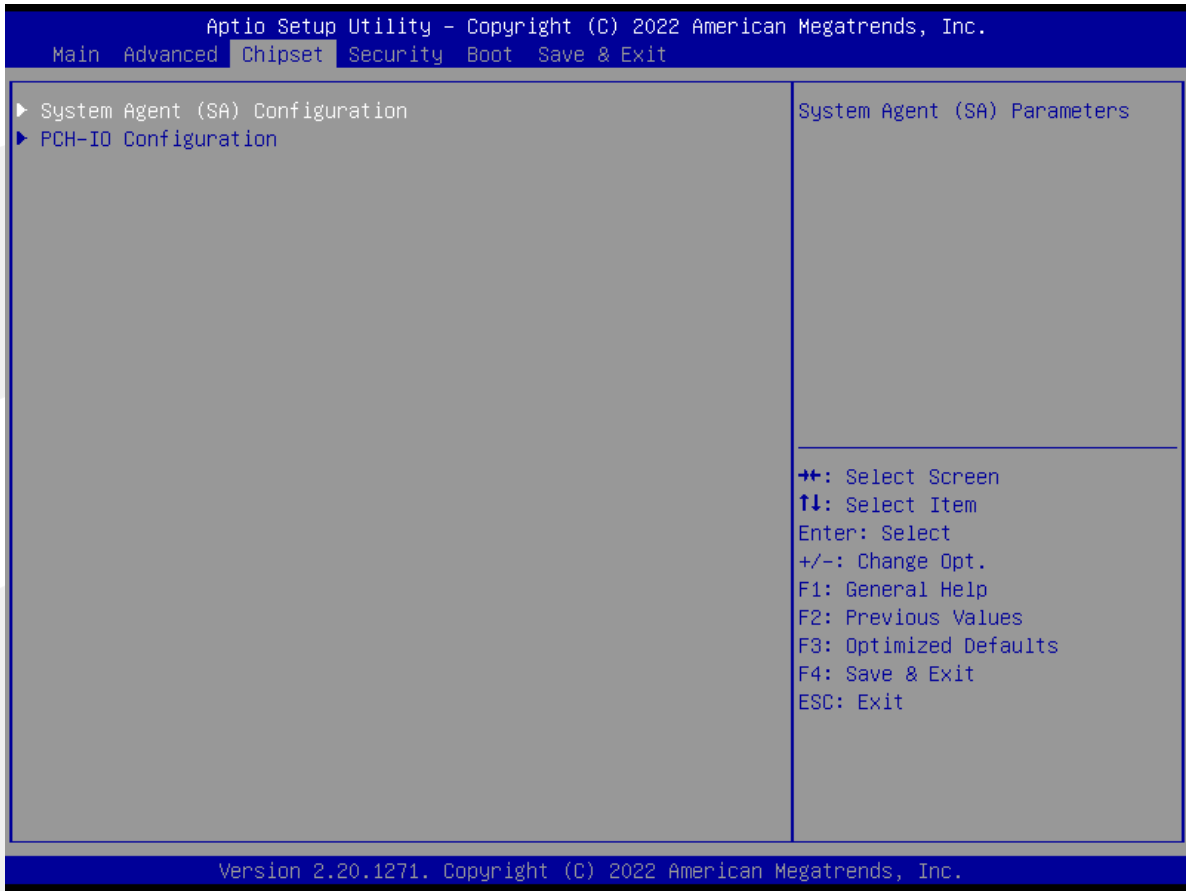

Setup Item	Options	Help Text	Comments
Chipset Screen			
System Agent (SA) Configuration		System Agent (SA) Parameters.	
PCH-IO Configuration		PCH Parameters.	

3.3.1 System Agent (SA) Configuration

The North Bridge Screen allows user to set NB chipset configuration. To access this screen, form the Main screen, choose **Chipset > System Agent (SA) Configuration**.

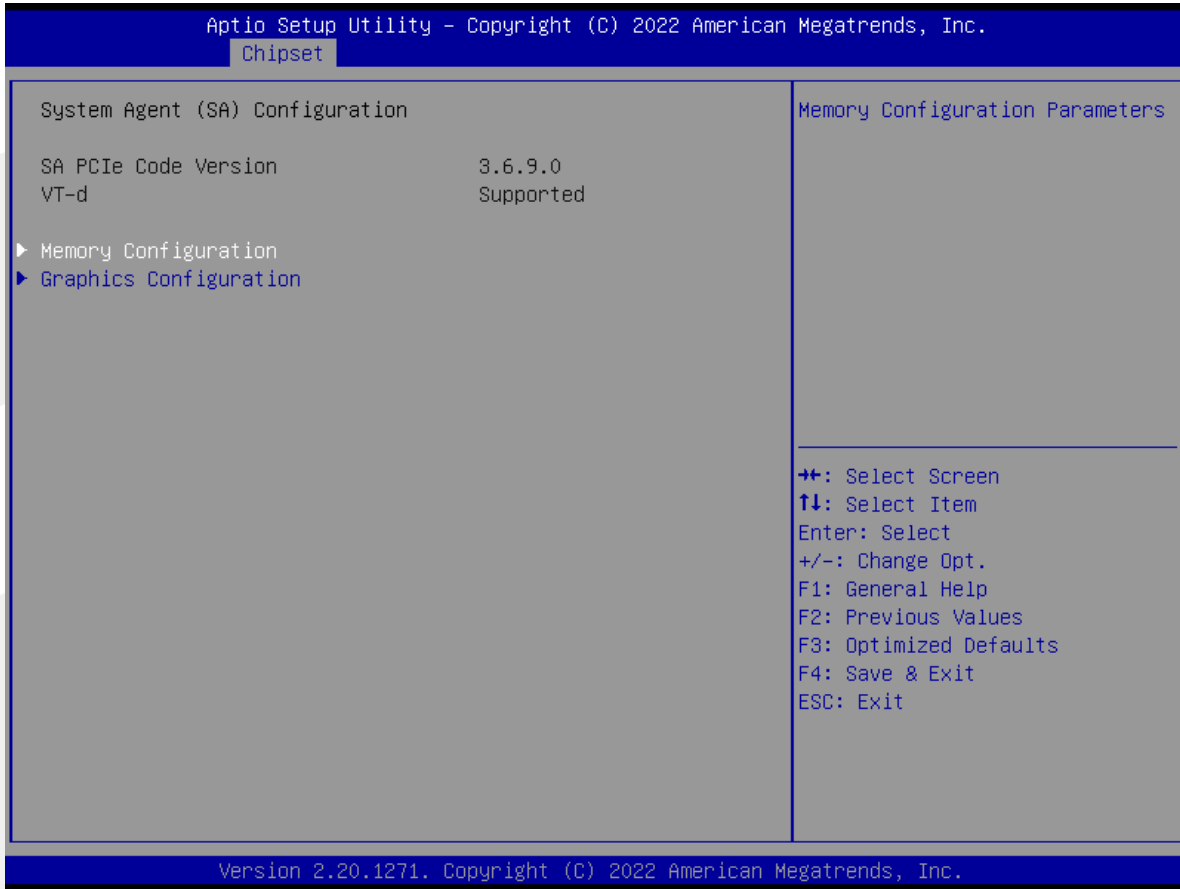

Aptio Setup Utility - Copyright (C) 2022 American Megatrends, Inc.
Chipset

System Agent (SA) Configuration	Memory Configuration Parameters
SA PCIe Code Version VT-d	3.6.9.0 Supported
▶ Memory Configuration ▶ Graphics Configuration	
	++: Select Screen ↑↓: Select Item Enter: Select +/-: Change Opt. F1: General Help F2: Previous Values F3: Optimized Defaults F4: Save & Exit ESC: Exit

Version 2.20.1271. Copyright (C) 2022 American Megatrends, Inc.

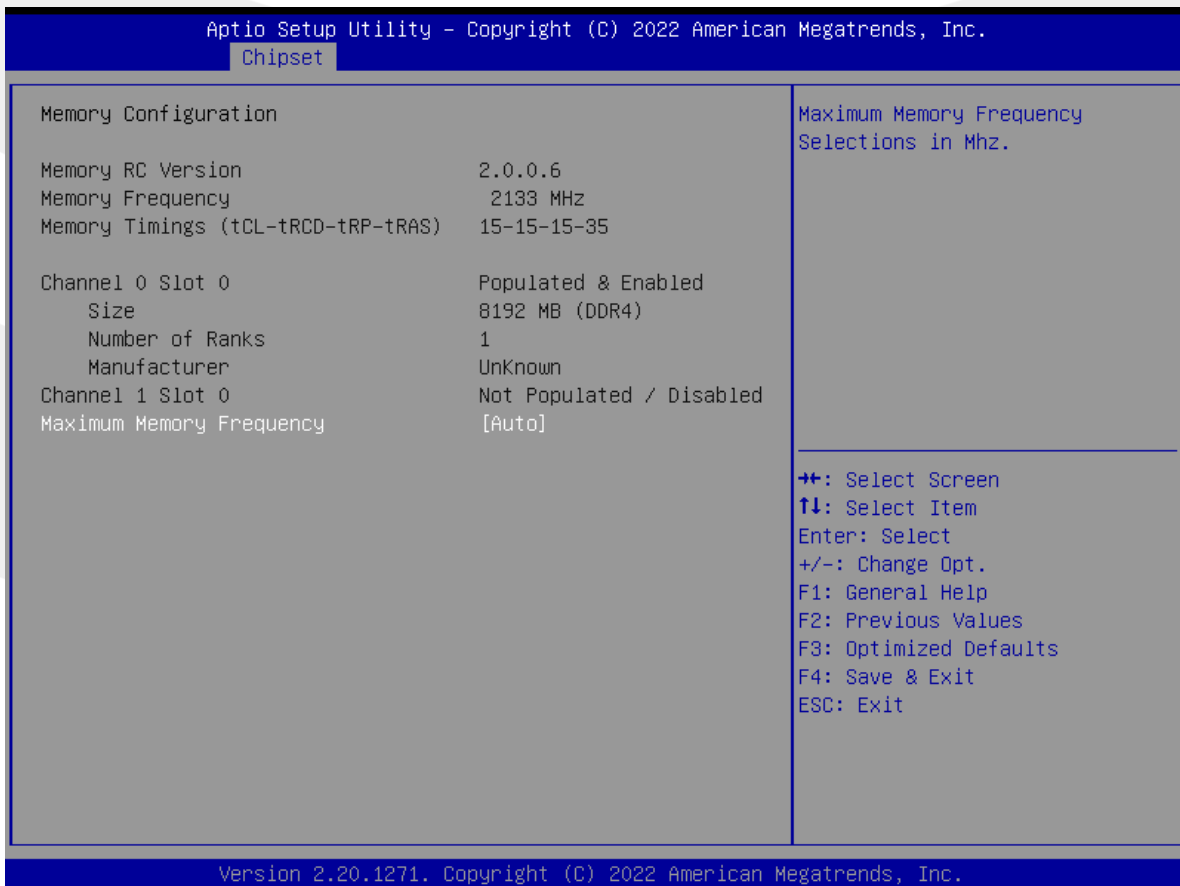

Aptio Setup Utility - Copyright (C) 2022 American Megatrends, Inc.
Chipset

Memory Configuration	Maximum Memory Frequency Selections in Mhz.
Memory RC Version Memory Frequency Memory Timings (tCL-tRCD-tRP-tRAS)	2.0.0.6 2133 MHz 15-15-15-35
Channel 0 Slot 0 Size Number of Ranks Manufacturer	Populated & Enabled 8192 MB (DDR4) 1 UnKnown
Channel 1 Slot 0 Maximum Memory Frequency	Not Populated / Disabled [Auto]
	++: Select Screen ↑↓: Select Item Enter: Select +/-: Change Opt. F1: General Help F2: Previous Values F3: Optimized Defaults F4: Save & Exit ESC: Exit

Version 2.20.1271. Copyright (C) 2022 American Megatrends, Inc.

Aptio Setup Utility - Copyright (C) 2022 American Megatrends, Inc.

Chipset

<p>Graphics Configuration</p> <p>Graphics Turbo IMON Current 31</p> <p>Skip Scanning of External Gfx Card [Disabled]</p> <p>Primary Display [Auto]</p> <p>Select PCIE Card [Auto]</p> <p>Internal Graphics [Auto]</p> <p>GTT Size [8MB]</p> <p>Aperture Size [256MB]</p> <p>DVMT Pre-Allocated [32M]</p> <p>DVMT Total Gfx Mem [256M]</p> <p>▶ LVDS Control</p>	<p>Graphics turbo IMON current values supported (14-31)</p> <hr/> <p>←+: Select Screen ↑↓: Select Item Enter: Select +/-: Change Opt. F1: General Help F2: Previous Values F3: Optimized Defaults F4: Save & Exit ESC: Exit</p>
--	---

Version 2.20.1271. Copyright (C) 2022 American Megatrends, Inc.

Aptio Setup Utility - Copyright (C) 2022 American Megatrends, Inc.

Chipset

<p>LVDS Control</p> <p>Primary IGFX Boot Display [VBIOS Default]</p> <p>LCD Panel Type [VBIOS Default]</p> <p>Panel Scaling [Auto]</p> <p>Backlight Control [PWM Inverted]</p> <p>Active LFP [No eDP]</p> <p>Panel Color Depth [18 Bit]</p> <p>Backlight Brightness 255</p>	<p>Select the Video Device which will be activated during POST. This has no effect if external graphics present. Secondary boot display selection will appear based on your selection. VGA modes will be supported only on primary display</p> <hr/> <p>←+: Select Screen ↑↓: Select Item Enter: Select +/-: Change Opt. F1: General Help F2: Previous Values F3: Optimized Defaults F4: Save & Exit ESC: Exit</p>
--	--

Version 2.20.1271. Copyright (C) 2022 American Megatrends, Inc.

Setup Item	Options	Help Text	Comments
System Agent (SA) Configuration			
Memory Configuration			
Memory Information		Show Memory information.	
Graphics Configuration			
Primary Display	Auto		
Select PCIE Card	Auto		
Internal Graphics	Auto Disabled Enabled	Keep IGFX enabled based on the setup options.	
GTT Size	2MB 4MB 8MB	Select the GTT Size.	
Aperture Size	128MB 256MB 512MB 1024MB 2048MB	Select the Aperture Size. Note: Above 4GB MMIO BIOS assignment is automatically enabled when selecting 2048MB aperture. To use this feature, please disable CSM Support.	
DVMT Pre-Allocated	32M		
DVMT Total Gfx Mem	128M 256M MAX	Select DVMT5.0 Total Graphic Memory size used by the Internal Graphics Device.	
LCD Control			
Primary IGFX Boot Display	VBIOS Default HDMI EXT DP EXT HDMI DP	Select the Video Device which will be activated during POST. This has no effect if external graphics present.	
LCD Panel Type	VBIOS Default		
Panel Scanling	Auto		
Backlight Control	PWM Inverted		
Active LFP	No Edp		
Panel Color Depth	18 Bit		
Backlight Brightness	255		

3.3.2 PCH-IO Configuration

The South Bridge Screen allows user to set SB chipset configuration. To access this screen form the Main screen, choose **Chipset > PCH-IO Configuration**.

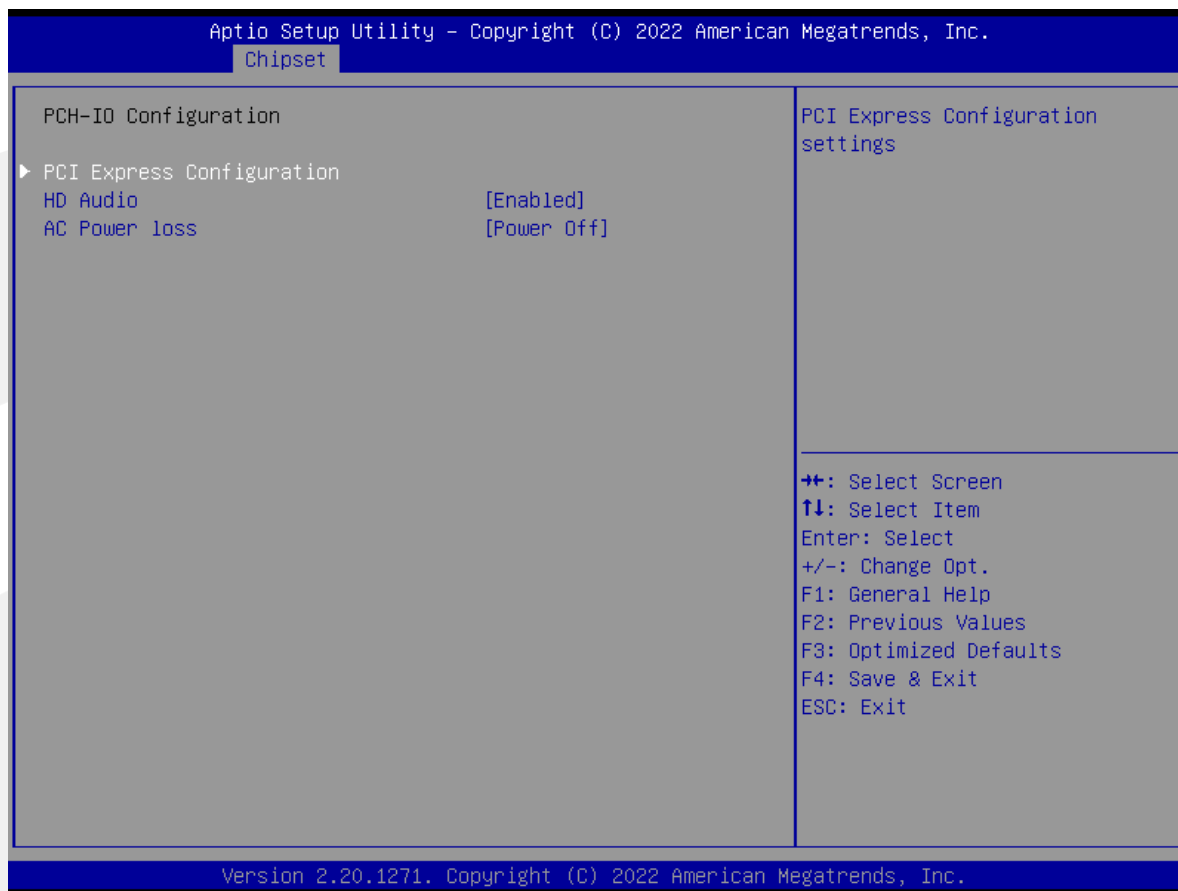

Setup Item	Options	Help Text	Comments
PCH-IO Configuration			
PCI Express Configuration			
HD Audio	Enabled		
AC Power Loss	Power off Power on	Select AC power state when power is re-applied after a power failure.	

3.4 Security

To access this screen form the Main screen, choose **Security**.

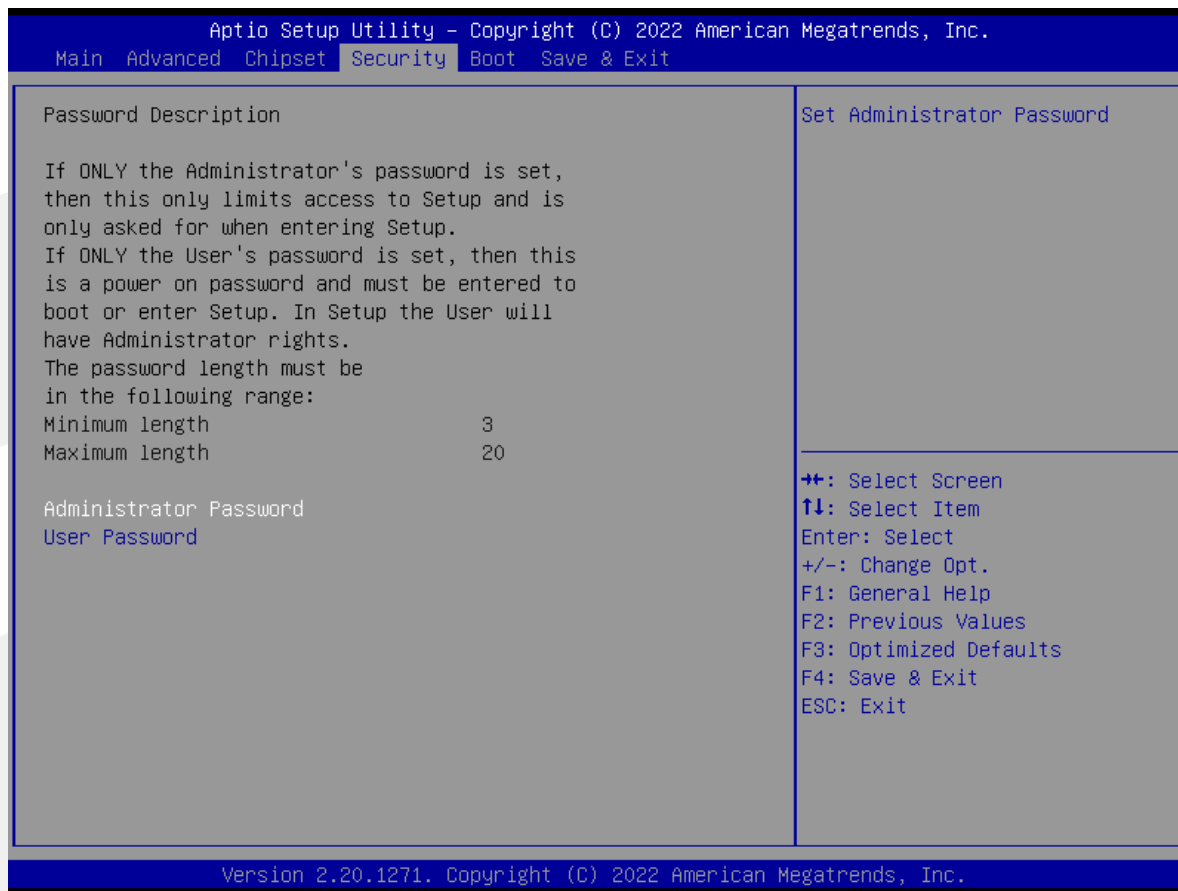

Setup Item	Options	Help Text	Comments
Security			
Administrator Password		Set Administrator Password.	
User Password		Set User Password.	

3.5 Boot Screen

The Boot screen displays any bootable media encountered during POST, and allows the user to configure desired boot device. To access this screen from the Main screen, choose **Boot**.

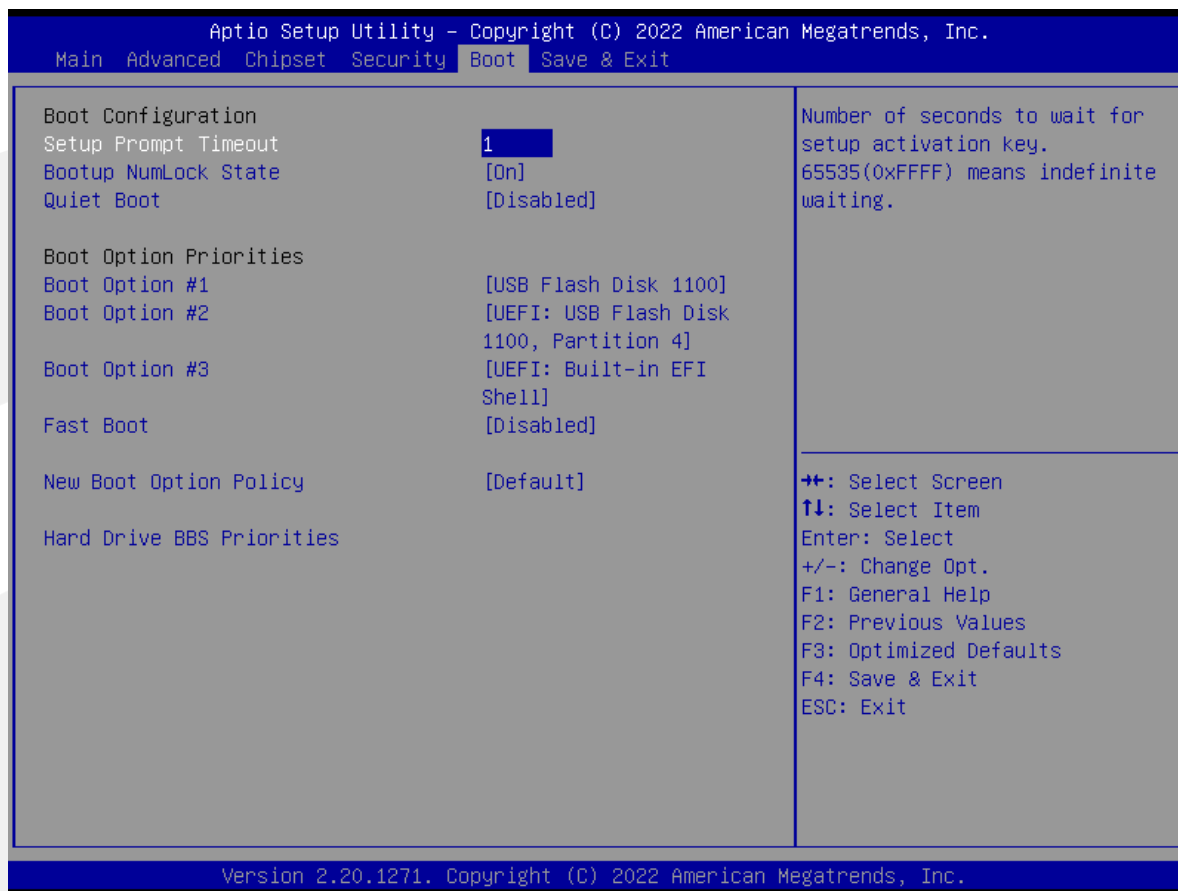

Setup Item	Options	Help Text	Comments
Boot Configuration			
Setup Prompt Timeout	1~65535	Number of seconds to wait for setup activation key.65535(0xFFFF) means indefinite waiting.	
Bootup NumLock State	On off	Select the keyboard Number state.	
Quiet Boot	Disabled Enabled	Enables or disables Quiet Boot option.	
Boot Option Priorities			
Boot Option #1		Sets the system boot order.	Note : Showed When boot devices existed.
Boot Option #2		Sets the system boot order.	
Boot Option #3		Sets the system boot order.	
Fast Boot	Disabled		
New Boot Option Policy	Default		
Hard Drive BBS Priorities		Set the order of the legacy devices in this group.	Set boot order in each group of the same kind, such as HDD, network.

3.6 Save & Exit Screen

The Save & Exit screen allows the user to choose whether to save or discard the configuration changes made on the other screens. It also allows the user to restore the server to the factory defaults or to save or restore them to set of user-defined default values.

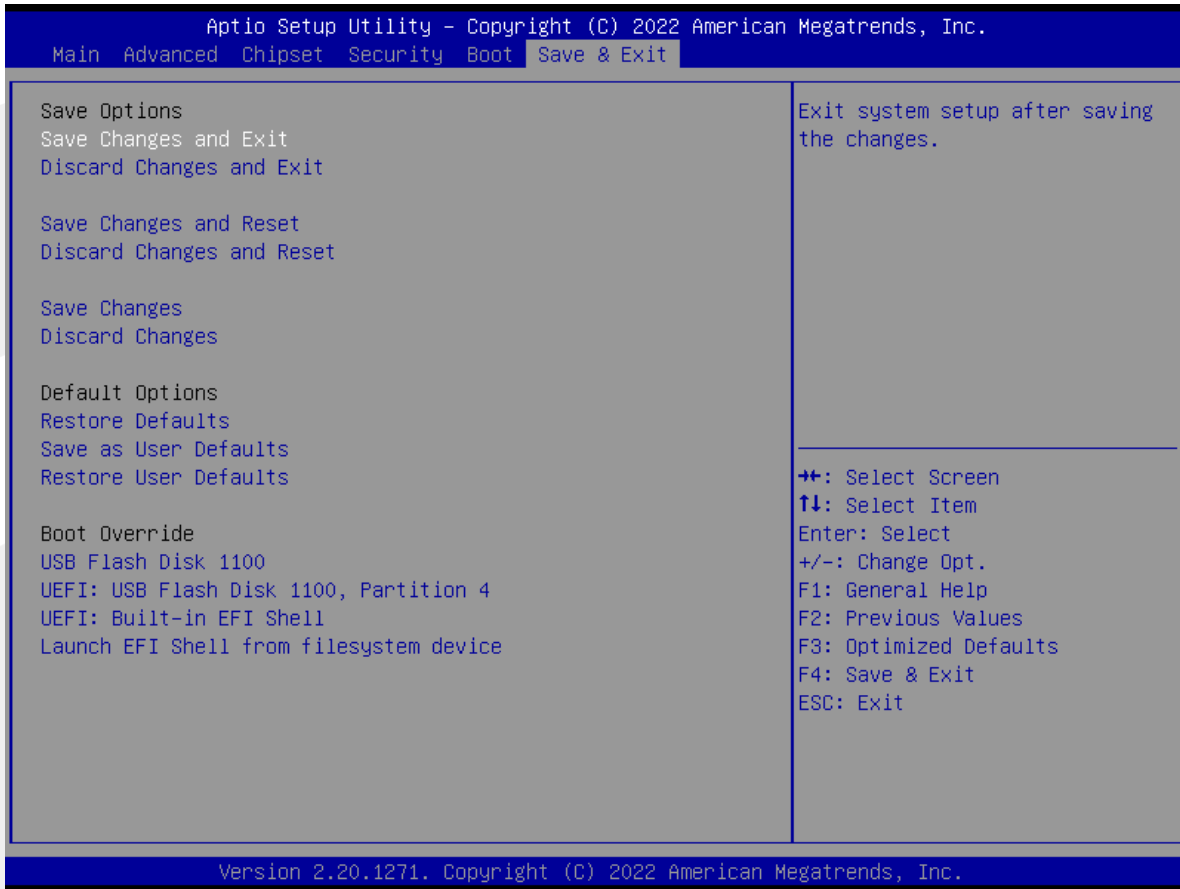

Setup Item	Options	Help Text	Comments
Save & Exit Screen			
Save Changes and Exit		Exit system setup after saving the changes.	
Discard Changes and Exit		Exit system setup without saving any changes.	User is prompted for confirmation only if any of the setup fields were modified.
Save Changes and Reset		Reset the system after saving the changes.	
Discard Changes and Reset		Reset system setup without saving and changes.	
Save Changes			
Discard Changes			
Default Options			
Restore Defaults		Restore/Load Default values for all the setup options.	
Save as User Defaults		Save the changes done so far as User Defaults.	

Setup Item	Options	Help Text	Comments
Restore User Defaults		Restore the User Defaults to all the setup options.	
Boot Override			
Shows the Device can boot.			Note : Showed When boot devices existed.

附录

附一：术语表

ACPI 高级配置和电源管理

ACPI 规范允许操作系统控制计算机及其附加设备的大部份电能。

BIOS 基本输入/输出系统

是在 PC 中包含所有的输入/输出控制代码界面的软件。它在系统启动时进行硬件检测，开始操作系统的运作，在操作系统和硬件之间提供一个界面。BIOS 是存储在一个只读存储器芯片内。

BUS 总线

在计算机系统中，不同部件之间交换数据的通道，是一组硬件线路。我们所指的 BUS 通常是 CPU 和主内存元件内部的局部线路。

Chipset 芯片组

是为执行一个或多个相关功能而设计的集成芯片。我们指的是由南桥和北桥组成的系统级芯片组，他决定了主板的架构和主要功能。

CMOS 互补金属

氧化物半导体。是一种被广泛应用的半导体类型。它具有高速、低功耗的特点。我们指的 CMOS 是在主板上的 CMOS RAM 中预留的一部份空间，用来保存日期、时间、系统信息和系统参数设定信息等。

COM 串口

一种通用的串行通信接口，一般采用标准 DB9 公头接口连接方式。

DIMM 双列直插式内存模块

是一个带有内存芯片组的小电路板。提供 64bit 的内存总线宽度。

DRAM 动态随机存取存储器

是一个普通计算机的通用内存类型。通常用一个晶体管和一个电容来存储一个位。随着技术的发展，DRAM 的类型和规格已经在计算机应用中变得越来越多样化。例如现在常用的就有 SDRAM、DDR SDRAM 和 RDRAM。

L2c

Inter-Integrated Circuit 总线是一种由 PHILIPS 公司开发的两线式串行总线，用于连接微控制器及其外围设备。

LAN 局域网络接口

一个小区域内相互关联的计算机组成的一个计算机网络，一般是在一个企事业单位或一栋建筑物。局域网一般由服务器、工作站、一些通信链接组成，一个终端可以通过电线访问数据和设备的任何地方，许多用户可以共享昂贵的设备和资源。

LED 发光二极管

一种半导体设备，当电流流过时它会被点亮，通常用来把信息非常直观地表示出来，例如表示电源已经导通或硬盘驱动器正在工作等。

PnP 即插即用

允许 PC 对外接设备进行自动配置，不用用户手动操作系统就可以自己工作的一种规格。为实现这个特点，BIOS 支持 PnP 和一个 PnP 扩展卡都是必需的。

POST 上电自检

在启动系统期间，BIOS 会对系统执行一个连续的检测操作，包括检测 RAM，键盘，硬盘驱动器等，看它们是否正确连接和是否正常工作。

PS/2

由 IBM 发展的一种键盘和鼠标连接的接口规范。PS/2 是一个仅有 6PIN 的 DIN 接口，也可以用以连接其他的设备，比如调制解调器。

USB 通用串行总线

一种适合低速外围设备的硬件接口，一般用来连接键盘、鼠标等。一台 PC 最多可以连接 127 个 USB 设备，提供一个 12Mbit/s 的传输带宽；USB 支持热插拔和多数数据流功能即在系统工作时可以插入 USB 设备，系统可以自动识别并让插入的设备正常。

深圳智锐通科技有限公司
Shenzhen Zrt Co., Ltd.



智锐通公众号

&



智锐通抖音号

- 集团总部：深圳市宝安区碧桂园凤凰智谷A栋21楼
- 北京分公司：北京市昌平区科兴西路106号院2号楼5层
- 南京分公司：南京市江宁区万科都荟天地B2栋7楼
- 苏州分公司：苏州市虎丘区港龙城市广场4栋13楼
- 成都分公司：成都市武侯区世纪百合尚寓3栋10楼
- 400-838-6869