

# MIN-EC09C

边缘整机

USER' Manual V10

## USER'S MANUAL 用户手册

## 声明

本使用说明书内容如有变更，恕不另行通知。本公司并不对本使用说明书之适用性，适合做某种特殊用途之使用或其他任何事项做任何明示，或做其他形式之保证或担保。因此本公司将不对手册内容之错误，或因增减展示或以其他方式使用本手册所造成之直接，间接，突发性过、或继发性之损害负任何责任。

版权声明：

版权所有----深圳智锐通科技有限公司。未经本公司许可或依著作权法之规定许准，不得复制，节录和翻译使用说明书之任何内容。

## 安全须知

1	产品使用前，务必仔细阅读产品说明书。
2	对未准备安装的板卡，应将其保存在防静电保护袋中。
3	在从包装袋中拿板卡前，应将手先置于接地金属物体上一会儿，以释放身体及手中的静电。
4	在拿板卡时，需佩带静电保护手套，并且应该养成只触及边缘部份的习惯。
5	主板与电源连接时，请确认电源电压。
6	为避免人本被电击或产品被损坏，在每次对主板、板卡进行拔插或生新配置时须先关闭交流电源或将交流电源线从电源插座中拔掉。
7	在对板卡进行搬动前，先将交流电源线从电源插座中拔掉。
8	当您需连接或拔除任何设备前，须确定所有的电源线事先已被拔掉。
9	为避免频繁开关机对产品造成不必要的损伤,关机后,应至少等待30秒后再开机。
10	设备在使用过程时出现异常情况，请找专业人员处理。

# 目录

<b>第一章 产品介绍</b> .....	6
<b>1.1 产品规格</b> .....	6
<b>1.2 功能框图</b> .....	8
<b>1.3 产品照片</b> .....	9
<b>第二章 安装说明</b> .....	11
<b>2.1 接口/尺寸图</b> .....	11
<b>2.2 插针接口定义</b> .....	12
<b>第三章 BIOS 程序设置</b> .....	13
<b>3.1 Main Screen</b> .....	14
<b>3.2 Advanced Screen</b> .....	16
<b>3.2.1 CPU Configuration Screen</b> .....	17
<b>3.2.2 ACPI Settings Screen</b> .....	20
<b>3.2.3 Super IO Configuration</b> .....	21
<b>3.2.3.1 Serial PortX Configuration</b> .....	22
<b>3.2.4 Hardware Monitor</b> .....	23
<b>3.2.5 SATA Configuration</b> .....	25
<b>3.2.6 USB Configuration</b> .....	26
<b>3.2.7 CSM Configuration</b> .....	28
<b>3.2.8 NVMe Configuration</b> .....	29
<b>3.2.9 Watchdog Configuration</b> .....	30
<b>3.2.10 PXE Boot</b> .....	31
<b>3.3 Chipset Screen</b> .....	32

---

3.3.1 System Agent (SA) Configuration.....	33
3.3.2 PCH-IO Configuration.....	36
3.4 Security.....	37
3.5 Boot Screen.....	38
3.6 Save & Exit Screen.....	39
第四章 故障问题排除.....	40
附录.....	41
附一：术语表.....	41

## 第一章 产品介绍

### 1.1 产品规格

Model		MIN-EC09C		
<b>产品类型</b> Form Factor	<b>产品类型</b> Form Factor	边缘整机		
<b>处理器</b> Processor System	<b>CPU</b>	Intel 9 <sup>th</sup> Coffee Lake-H I3/I5/I7 LGA1440		
	<b>处理器</b> CPU	I7-9850H	I7-8850H	I5-8400H
	<b>内核数</b> Core Number	6	6	4
	<b>基本主频</b> Base Frequency	2.60GHz	2.60GHz	2.50GHz
	<b>最高主频</b> Max. Speed	4.60GHz	4.30GHz	4.20GHz
	<b>二级缓存</b> L2 Cache	12MB	9MB	8MB
	<b>功耗</b> TDP (W)	45W	45W	45W
	<b>芯片组</b> Chipset	Intel PCH QM370		
	<b>BIOS</b>	128Mb SPI FLASH		
<b>内存</b> Memory	<b>规格</b> Technology	DDR4		
	<b>最大容量</b> Max. Capacity	64G 3200MHz		
	<b>插槽</b> Socket	2 x SO-DIMM		
<b>扩展插槽</b> Expansion Slot	<b>M.2</b>	1 x M.2 Key-M(2242 / 2280) for PCIe/SATA 1 x M.2 Key-B(2242 / 2260 / 2280) for SATA & 4G/5G 1 x M.2 Key-E(2230) for WIFI		
	<b>SIM</b>	1 x SIM		
<b>存储</b> Storage	<b>SATA</b>	1 x SATA3.0(7 Pins)		
<b>显示</b> Graphics	<b>I/O</b>	1 x HDMI (From GPU DP_A DP to HDMI) 1 x DP (From GPU DP_B)		
	<b>分辨率</b> Resolution	HDMI2.0:4096*2160@60Hz DP:7680*4096@60Hz		

USB / Type-C	前面板 Front I/O	2 x USB2.0
	后面板 Rear I/O	3 x USB3.0 1 x Type C
	功能 Function	Support wake up from S3/S4
音频 Audio	控制器 Controller	Integrated High Definition Audio Stereo (ALC897)
	后面板 Rear I/O	1 x Line Out 1 x MIC In
以太网 Ethernet	控制器 Controller	Intel® Ethernet Controller I211-AT
	后面板 Rear I/O	2 x RJ45 10/100/1000M
	功能 Function	Support wake up and PXE
按钮 Button	前面板 Front I/O	1 x Power Button
	后面板 Rear I/O	1 x RV Button 1 x Reset Button
电源 Power Requirements	电源类型 Power Type	1 x DC In(4P In)
	电源电压 Power input Voltage	12~24V
环境 Environment	工作温度 Operating Temperature	0~50°C at 0.7m/s air flow
	存储温度 Storage Temperature	-20~70°C
	工作湿度 Operating Humidity	10~95%(non-condensing)
物理特性 Physical	尺寸 Dimensions	230*176*83.5mm
	颜色 Color	Gray
操作系统 OS	Microsoft	Windows 10 1809(RS5)/1607(RS1)
	Linux	Yocto YP3.1xLTS

## 1.2 功能框图

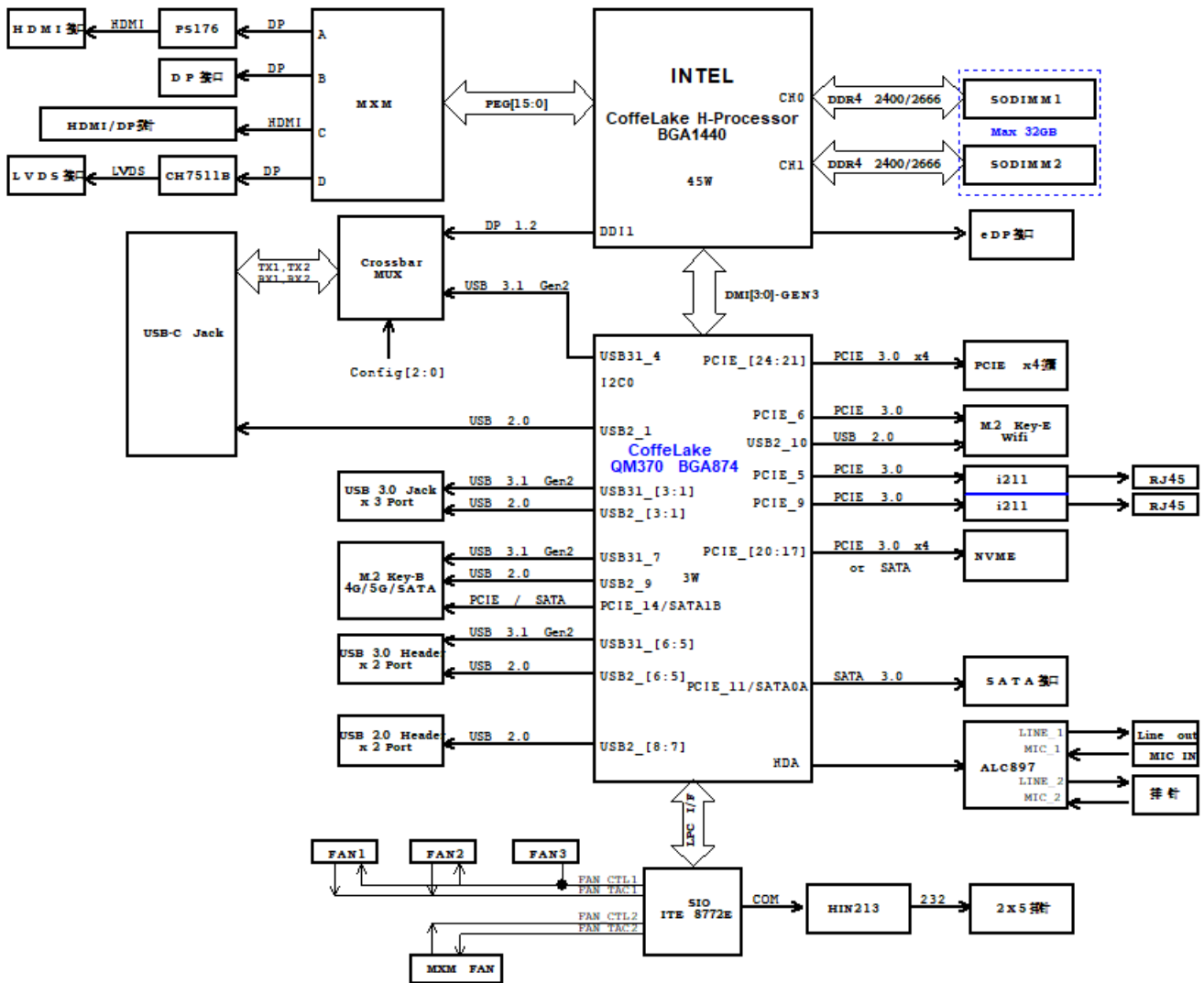



1.3 产品照片

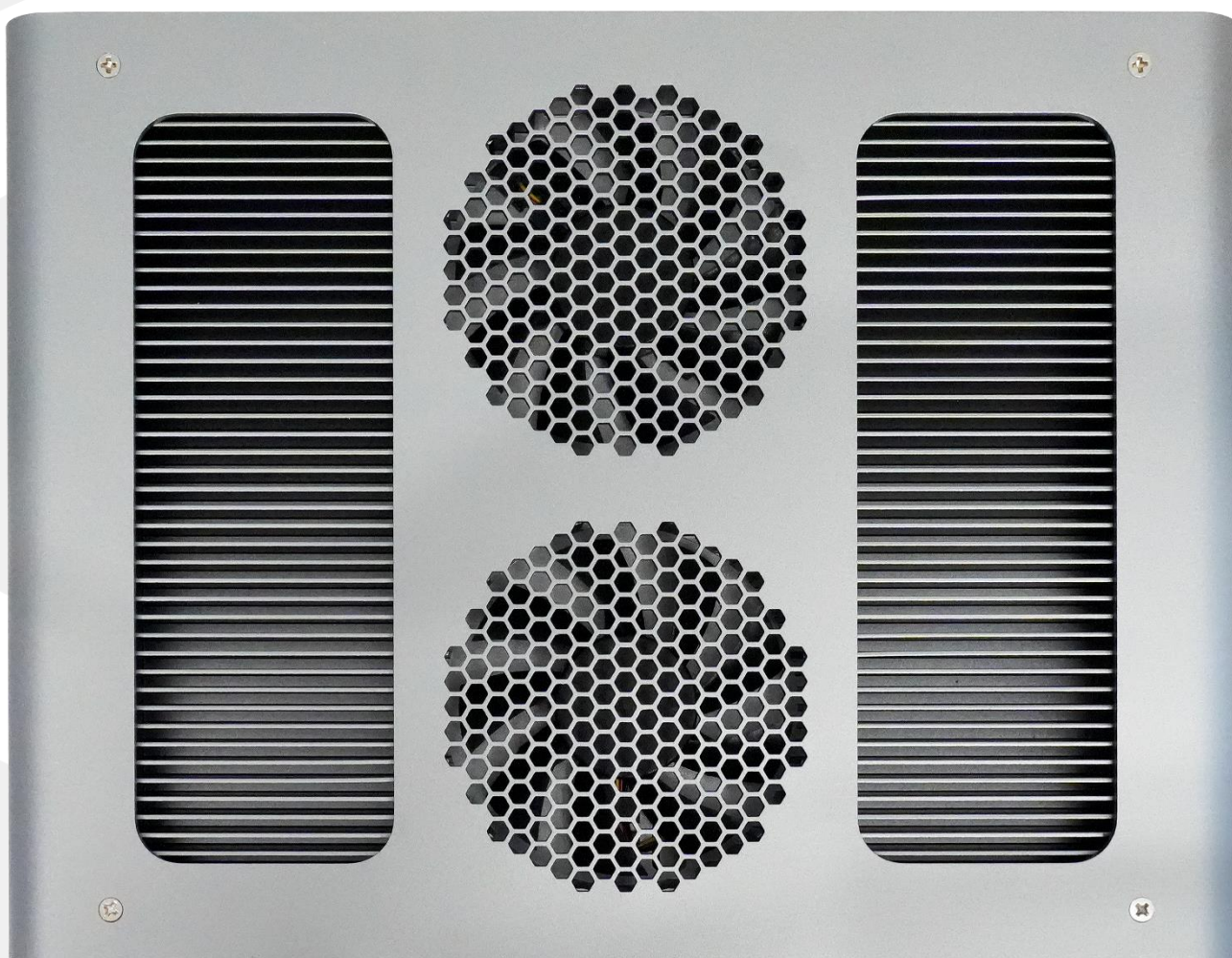

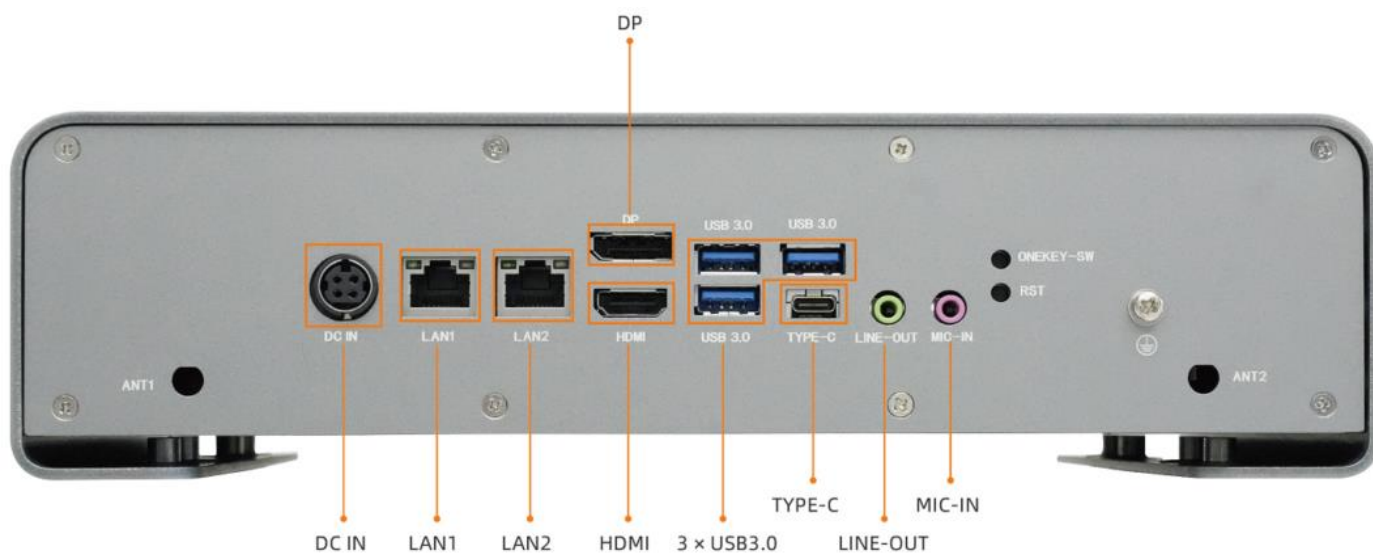

## 第二章 安装说明

### 2.1 接口/尺寸图

安装设备时, 请对照此示意图并仔细阅读下面的说明, 安装组件过程中必须小心, 对于有些部件, 如果安装不正确, 设备将不能正常工作。

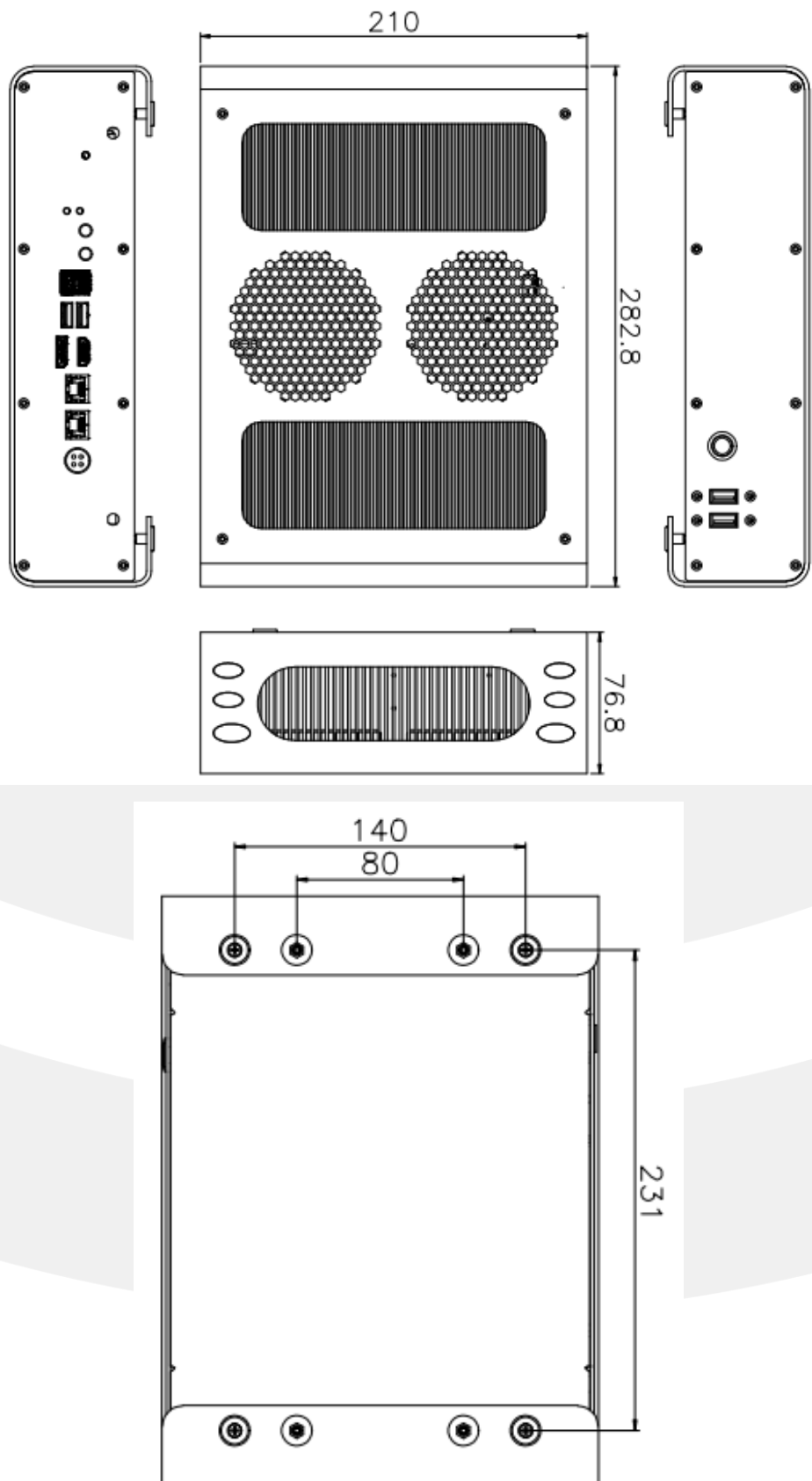

## 2.2 插针接口定义

后 IO 按键，SW1 定义如下：

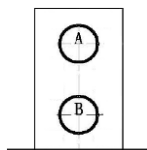

管脚	信号名称
上层	一键还原按钮
下层	系统重启

备注：使用一键还原操作系统，需先按要求制作 Legacy 系统的备份。

DC\_JACK2，供电接口定义如下：

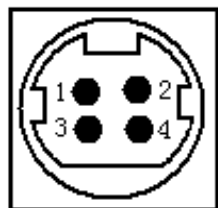

管脚	信号名称
1	VCC
2	VCC
3	GND
4	GND

备注：若接 MXM 显卡，推荐使用 19v/24V 供电，并保证电源功率及显卡散热良好。

SATA 电源接口，脚距 2.0mm，180 度带框插针定义如下：

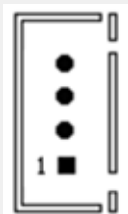

管脚	信号名称
1	12V
2	GND
3	GND
4	5V



## 第三章 BIOS 程序设置

### AMI BIOS 刷新

BIOS 提供对硬件资源的底层驱动，是联系硬件和操作系统的桥梁。现在硬件和各种应用软件不断更新，当您的系统遇到问题时，例如系统不支持最新公布的 CPU 时，就需要升级您的 BIOS 了。

**注意：**

1. **升级 BIOS 只在遇到问题，必要的时候进行。**
2. **升级 BIOS 请使用我们驱动光盘内所附的 BIOS 读写程序，或者在相关网站下载更新版本的程序。**
3. **在升级过程中不要关闭电源或重新启动系统，以免造成您的 BIOS 资料将被损坏，系统也可能不能启动。**
4. **为防止意外发生，请您先备份当前的 BIOS 资料。**

### AMI BIOS 描述

开机时，BIOS 会对主板上的硬件进行自我诊断，设定硬件时序参数等工作，最后才将系统控制权交给操作系统。如何正确的设定 BIOS 参数对系统是否稳定的工作及系统是否工作在最佳状态至关重要。

### 进入 BIOS 参数设置

电脑开机，在完成自我诊断后，屏幕上会显示出如下信息：Del->SETUP，此时您点击一下 Del 键，则 BIOS 在完成 IDE 等设备的侦测后会自动转入 SETUP 设置画面。

1. 打开系统电源或重新启动系统，显示器屏幕将出现自我测试的信息。
2. 当屏幕中间出现“Press<Del>to enter setup”提示时，按下<Del>键，就可以进入 BIOS 设定程序。
3. 以方向键移动至您要修改的选项，按下<Enter>键即可进入该选项的子画面。
4. 使用方向键及<Enter>键即可修改所选项目的值，按回车键选择 BIOS 选项并修改。
5. 任何时候按下<Esc>键即可回到上一画面。

## Setup Utility User Interface

This document describes BIOS Setup Utility user interface.

### 3.1 Main Screen

The Main screen is the first screen that is displayed when the BIOS Setup is entered.



Setup Item	Options	Help Text	Comments
<b>BIOS Information</b>			
BIOS Vendor			Displays BIOS vendor.
Core Version			
Compliance			
Project Version			Displays the current BIOS version: Format: AAAABBC <b>AAAAA</b> = <b>Project name</b> <b>BB</b> = <b>BIOS revision</b> <b>C</b> = <b>Customer number</b>
Build Date and Time			Displays the current BIOS build date.

Setup Item	Options	Help Text	Comments
Access Level			Displays password level that setup is running in: Administrator or User. With no passwords set, Administrator is the default mode.
<b>Process Information</b>			
CPU XXXXX			Displays the CPU BrandString installed in the system.
<b>Memory Information</b>			
Total Memory			Displays the total physical memory installed in the system, MB Unit.
Memory Frequency			
System Language	English	Choose the system default language.	
System Date	[Day of week MM/DD/YYYY]	Set and display the Date.	
System Time	[HH:MM:SS]	Set and display the Time.	

## 3.2 Advanced Screen

The Advanced screen provides an access point to configure several options. On this screen, the user selects the option that is to be configured.

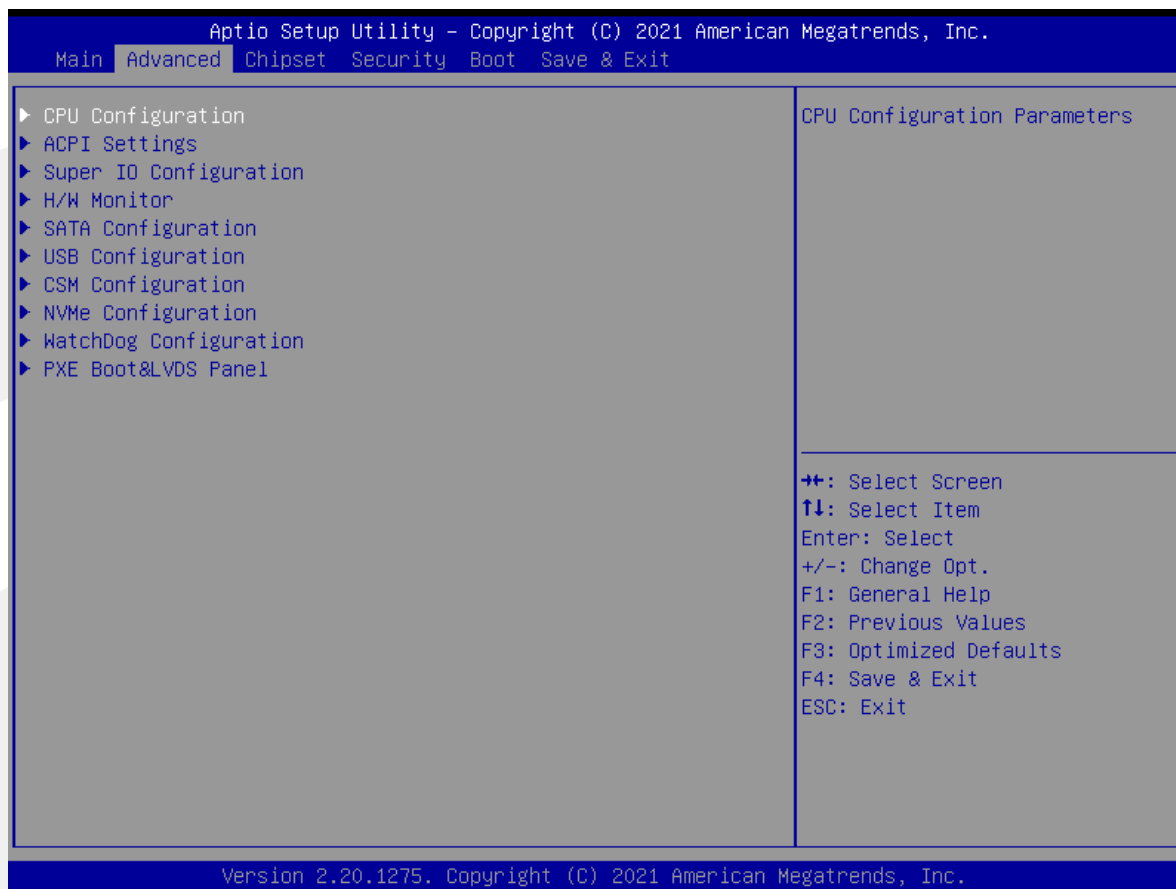

Setup Item	Options	Help Text	Comments
CPU Configuration		CPU Configuration Parameters.	
ACPI Settings		System ACPI Parameters.	
Super IO Configuration		System Super IO chip Parameters.	
H/W Monitor		Monitor hardware stats.	
SATA Configuration		SATA Devices Configuration.	
USB Configuration		USB Configuration Parameters.	
CSM Configuration		CSM configuration: Enable/Disable, Option ROM execution settings, etc.	
NVMe Configuratioin		NVMe Device Options Settings.	
Watchdog configuration		Set System WatchDog Parameters.	
PXE Boot&LVDS Panel		Legacy PXE&LVDS Support Control.	



### 3.2.1 CPU Configuration Screen

The CPU Configuration screen allows the user to view the processor information, and to enable or disable processor options. To access this screen from the Main screen, choose **Advanced > CPU Configuration**.

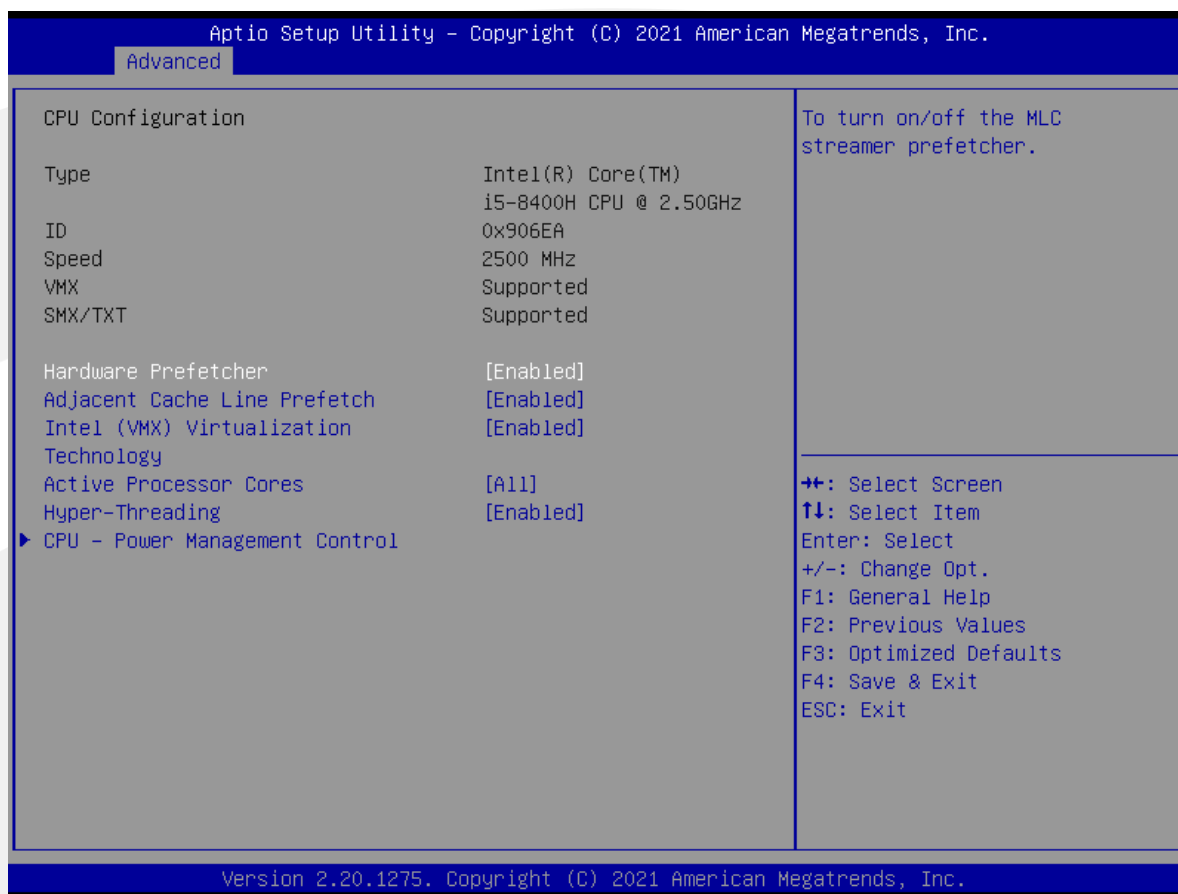

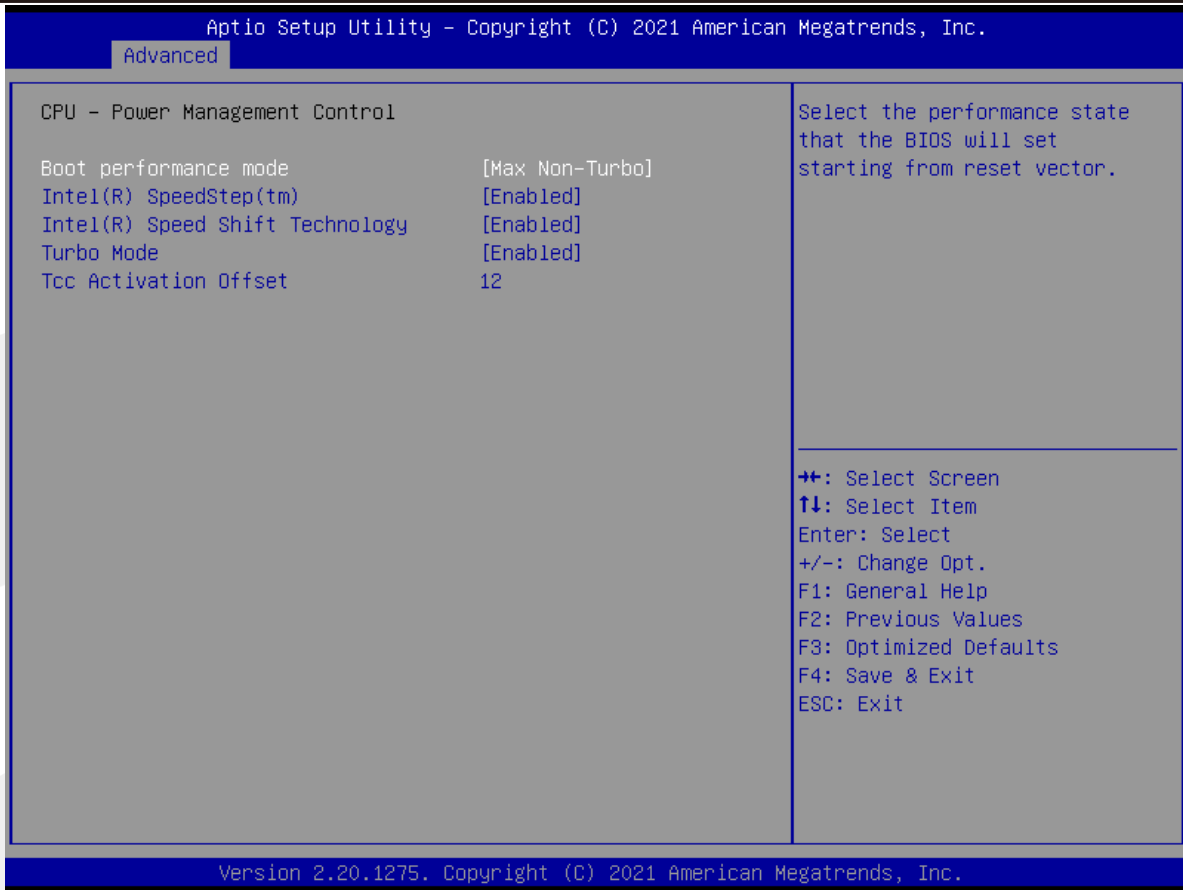

Setup Item	Options	Help Text	Comments
<b>CPU Configuration</b>			
Type			
ID			
Speed			
VMX			
SMX/TXT			
Hardware Prefetcher	Enabled Disabled	To turn on/off the MLC streamer prefetcher.	
Adjacent Cache Line Prefetch	Enabled Disabled	To turn on/off prefetching of adjacent cache lines.	
Intel(VMX) Virtualization Technology	Enabled Disabled	When enabled, a VMM can utilize the additional hardware capabilities provided by Vanderpool technology.	
Active Processor Cores	All 1 2 3	Number of cores to enable in each processor package.	
Hyper-Threading	Enabled		

Setup Item	Options	Help Text	Comments
<b>CPU - Power Management Control</b>			
Boot performance mode	Max Non-Turbo Max battery Turbo Performance	Select the performance state that the BIOS will set starting from reset vector.	
Intel® SpeedStep™	Enabled Disabled	Allows more than two frequency ranges to be supported.	
Intel® Speed Shift Technology	Enabled Disabled	Enable/Disable Intel® speed shift technology support.	
Turbo Mode	Enabled		
Tcc Activation Offset			

### 3.2.2 ACPI Settings Screen

The ACPI Settings screen allows the user to set the system ACPI parameters. To access this screen from the Main screen, choose **Advanced > ACPI Settings**.



Setup Item	Options	Help Text	Comments
<b>ACPI Settings</b>			
ACPI Sleep State	Suspend Disabled S3 (Suspend to RAM)	Select the highest ACPI sleep state the system will enter when the SUSPEND button is pressed.	Sleep supported optionally.

### 3.2.3 Super IO Configuration

The Super IO Configuration screen allows the user to view the super IO information, and to enable or disable super IO options. To access this screen from the Advanced screen, choose **Advanced > Super IO Configuration**.

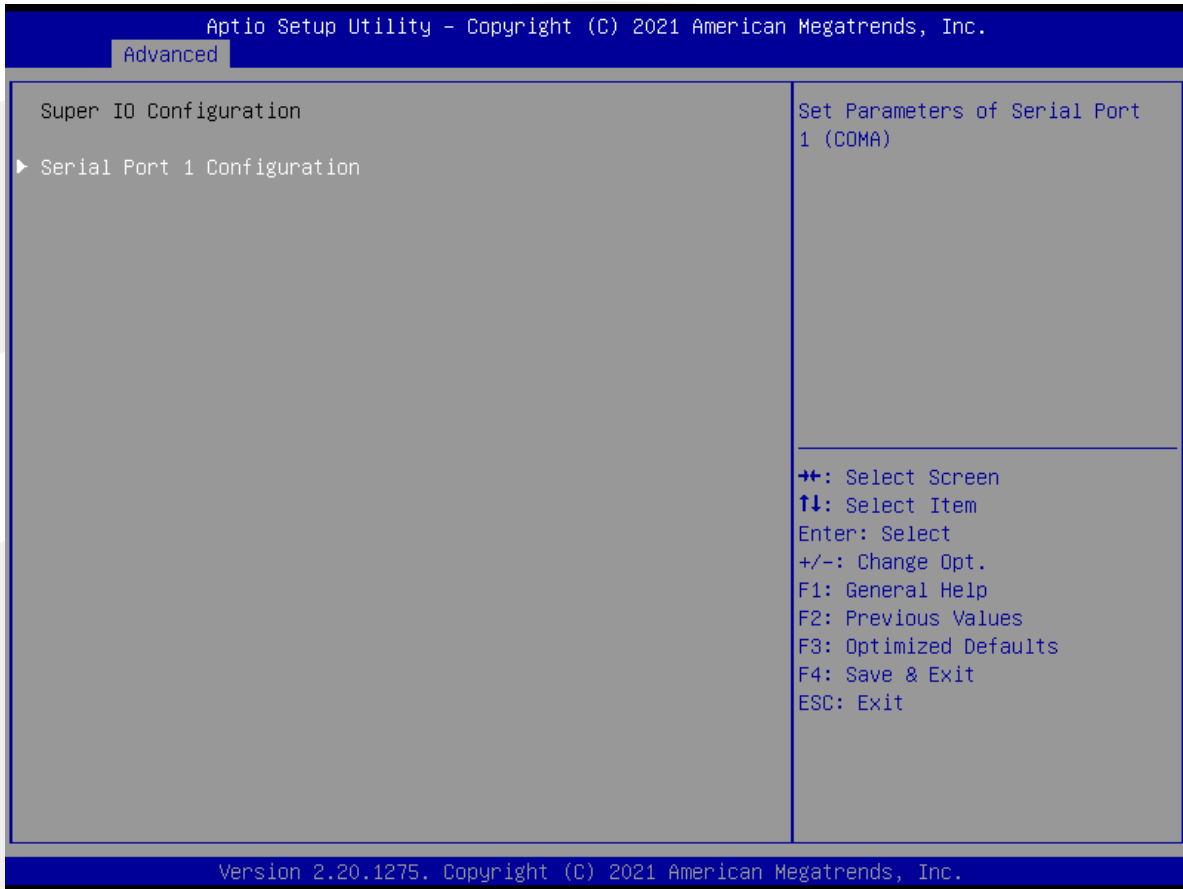

Setup Item	Options	Help Text	Comments
<b>Super IO Configuration</b>			
Serial Port 1 Configuration			Set Parameters of Serial Port 1 (COM1).

### 3.2.3.1 Serial PortX Configuration

The Super IO Configuration screen allows the user to view the super IO information, and to enable or disable serial port options. To access this screen from the Advanced screen, choose **Advanced-> Super IO Configuration->Serial PortX Configuration**.

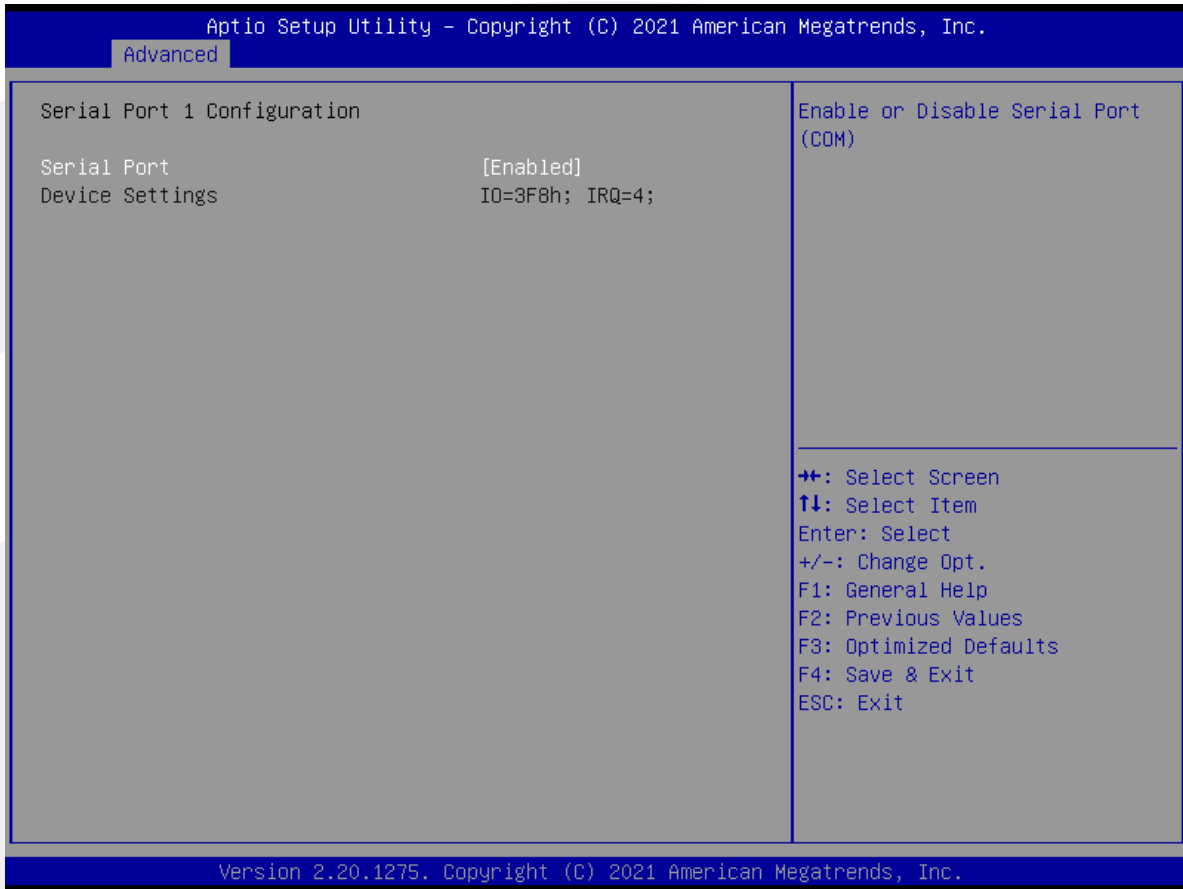

Setup Item	Options	Help Text	Comments
<b>Serial PortX Configuration</b>			
Serial Port	Enabled Disabled	Enable or Disable Serial Port (COM).	
Change Settings	Auto IO=3F8h; IRQ=4 IO=3F8h; IRQ=3,4,5,6,7,9,10,11,12 IO=2F8h; IRQ=3,4,5,6,7,9,10,11,12 IO=3E8h; IRQ=3,4,5,6,7,9,10,11,12 IO=2E8h; IRQ=3,4,5,6,7,9,10,11,12	Select an optimal settings for Super IO Device.	

### 3.2.4 Hardware Monitor

The hardware monitor screen allows the user to view the hardware information. To access this screen from the Advanced screen, choose **Advanced-> Hardware Monitor**.

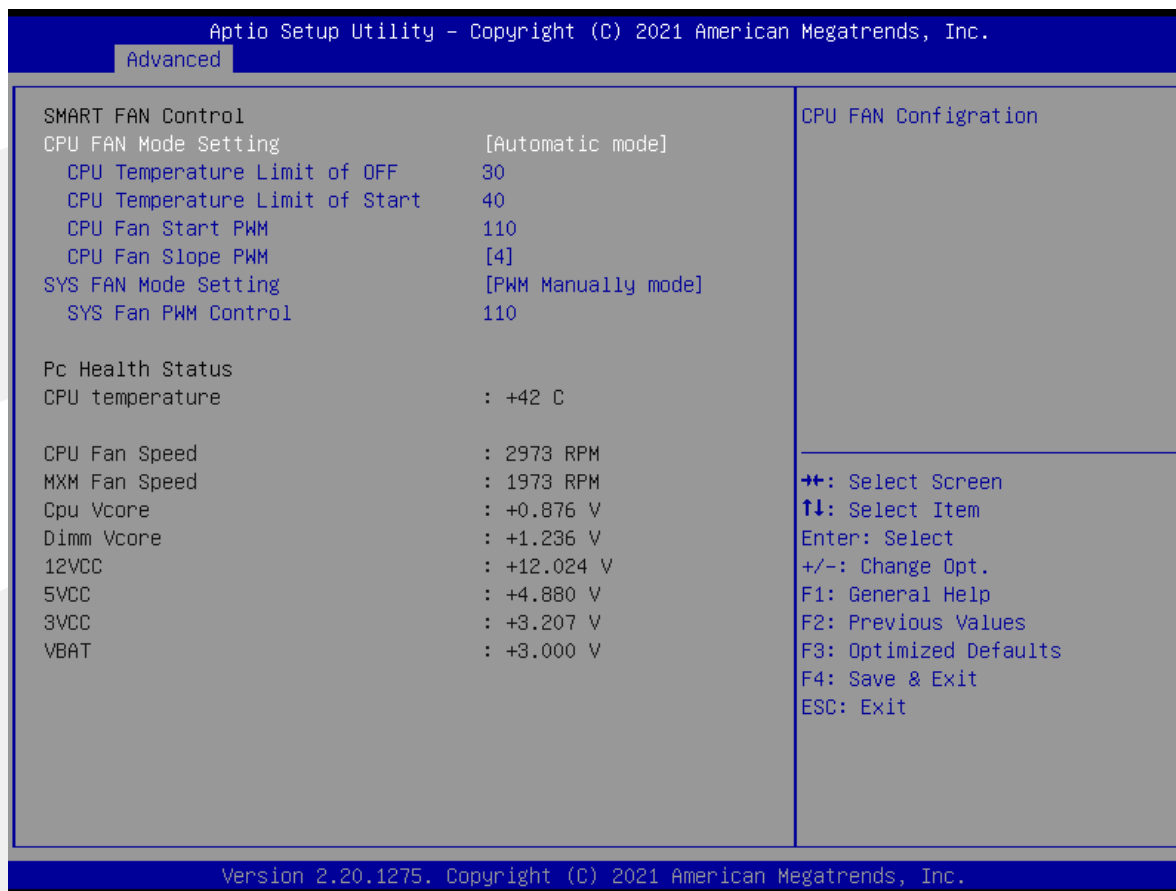

Setup Item	Options	Help Text	Comments
<b>Hardware Monitor</b>			
<b>SMART FAN Control</b>			
CPU Fan Mode Setting	Automatic mode Manual mode	CPU Fan control mode select.	When Manual mode selected, Manual PWM Setting shows to set FAN PWM Duty.
SYS Fan Mode Setting	Automatic mode Manual mode	SYS Fan control mode select.	When Manual mode selected, Manual PWM Setting shows to set FAN PWM Duty.
<b>PC Health Status</b>			
CPU temperature		Shows Current CPU temperature.	NOTE1: Sometimes not the actual temperature value, just indicates temperature tolerance limitation.

Setup Item	Options	Help Text	Comments
CPU Fan Speed			HW Information.
MXM Speed			
Cpu Vcore			
Dimm Vcore			
12VCC			
5VCC			
3VCC			
VBAT			



### 3.2.5 SATA Configuration

The SATA Configuration screen allows the user to view the SATA Controller information, and to enable or disable SATA Controller options. To access this screen from the Main screen, choose **Advanced > SATA Configuration**.

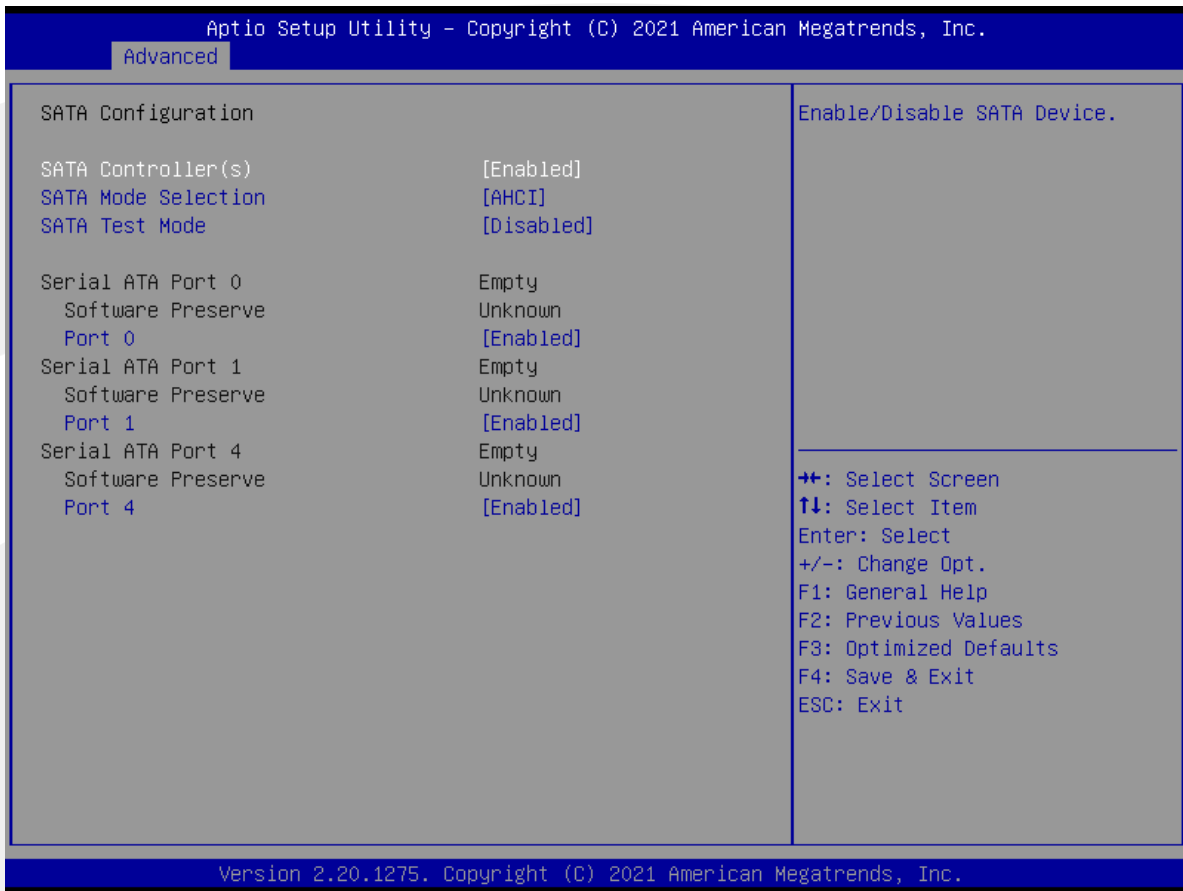

Setup Item	Options	Help Text	Comments
<b>SATA Configuration</b>			
SATA Controller(s)	Enabled Disabled	Enable / Disable SATA Device.	
SATA Mode Selection	AHCI Mode	Select AHCI.	
SATA Test Mode	Disabled		
Serial ATA Port 0			Show HDD information connected.
Serial ATA Port 1			
Serial ATA Port 4			

### 3.2.6 USB Configuration

The USB Configuration screen allows the user to view the USB Configuration information, and to enable or disable options. To access this screen from the Main screen, choose **Advanced > USB Configuration**.

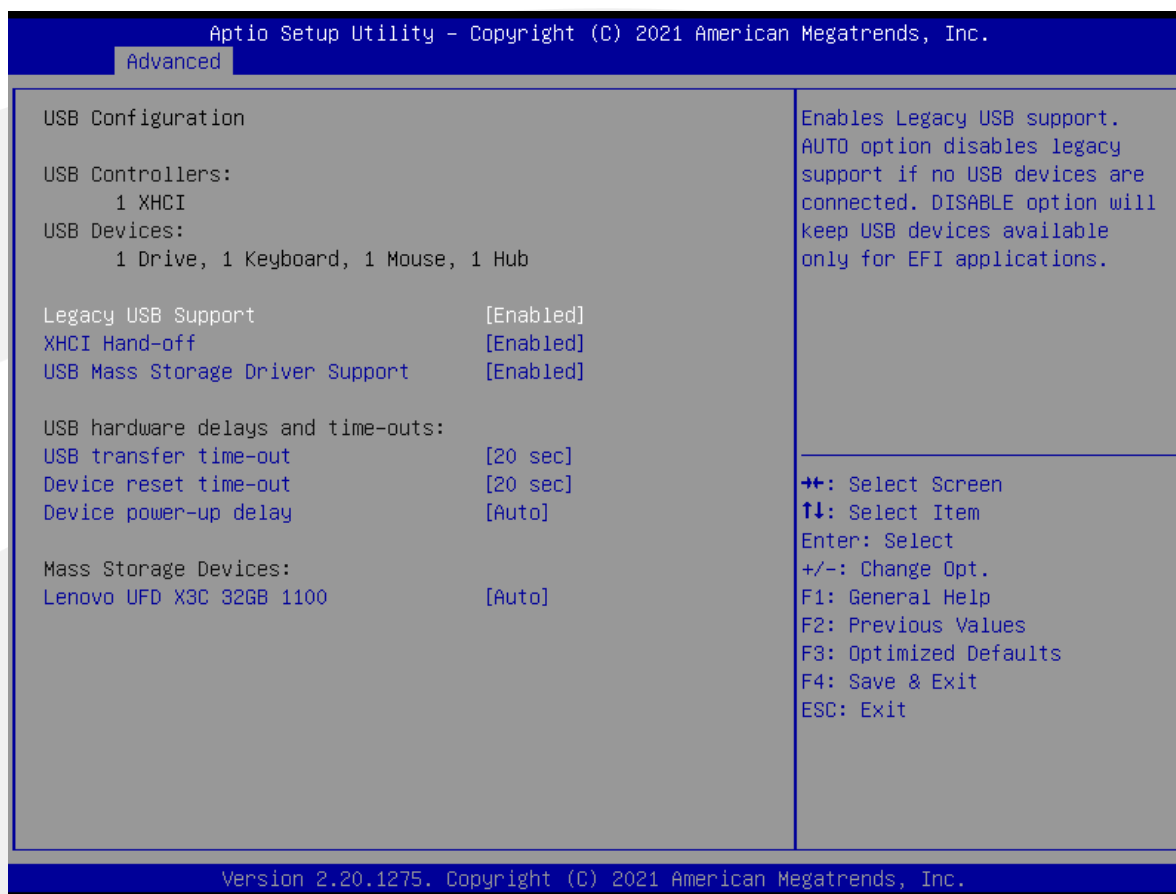

Setup Item	Options	Help Text	Comments
<b>USB Configuration</b>			
Legacy USB Support	Enabled Disabled	Enables Legacy USB support. AUTO option disables legacy support if no USB devices are connected. DISABLE option will keep USB devices available only for EFI applications.	
XHCI Hand-off	Enabled Disabled	This is a workaround for OSES without XHCI hand-off support. The XHCI ownership change should be claimed by XHCI driver.	
USB MASS Storage Driver Support	Enabled Disabled	Enable/Disable USB Mass Storage Driver Support.	
<b>USB hardware delays and time-outs:</b>			
USB transfer time-out	1 sec 5 sec 10 sec 20 sec	The time-out value for Control, Bulk, and Interrupt transfers.	

Setup Item	Options	Help Text	Comments
Device reset time-out	1 sec 5 sec 10 sec 20 sec	USB mass storage device Start Unit command time-out.	
Device power-up delay	Auto Manual	Maximum time the device will take before it properly reports itself to the Host Controller. ' auto' uses default value: for a Root port it is 100ms,for a Hub port the delay is taken from Hub descriptor.	



Setup Item	Options	Help Text	Comments
Other PCI devices	Legacy UEFI Do not lunch	Determines OpROM execution policy for devices other than Network, Storage or video.	

### 3.2.8 NVMe Configuration

The NVMe Configuration screen allows the user to view the NVMe device information. To access this screen from the Main screen, choose **Advanced > NVMe Configuration**.



Setup Item	Options	Help Text	Comments
<b>NVMe Configuration</b>			
Controller 0			Show NVMe device information connected.

### 3.2.9 Watchdog Configuration

The Watchdog Configuration screen allows the user to Set System WatchDog Parameters. To access this screen from the Main screen, choose **Advanced > Watchdog Configuration**.



Setup Item	Options	Help Text	Comments
<b>Watchdog Parameters</b>			
WatchDog Control	Disabled Enabled		WatchDog function.
WatchDog Count Mode	Minute Second		WatchDog Count Mode Selection.
WatchDog TimeOut Value	1		Fill WatchDog TimeOut (0~255),0 means function disabled.

### 3.2.10 PXE Boot

The PXE Boot screen allows the user to Enable or Disable Boot Option for Legacy Network Devices. To access this screen from the Main screen, choose **Advanced > PXE Boot**.

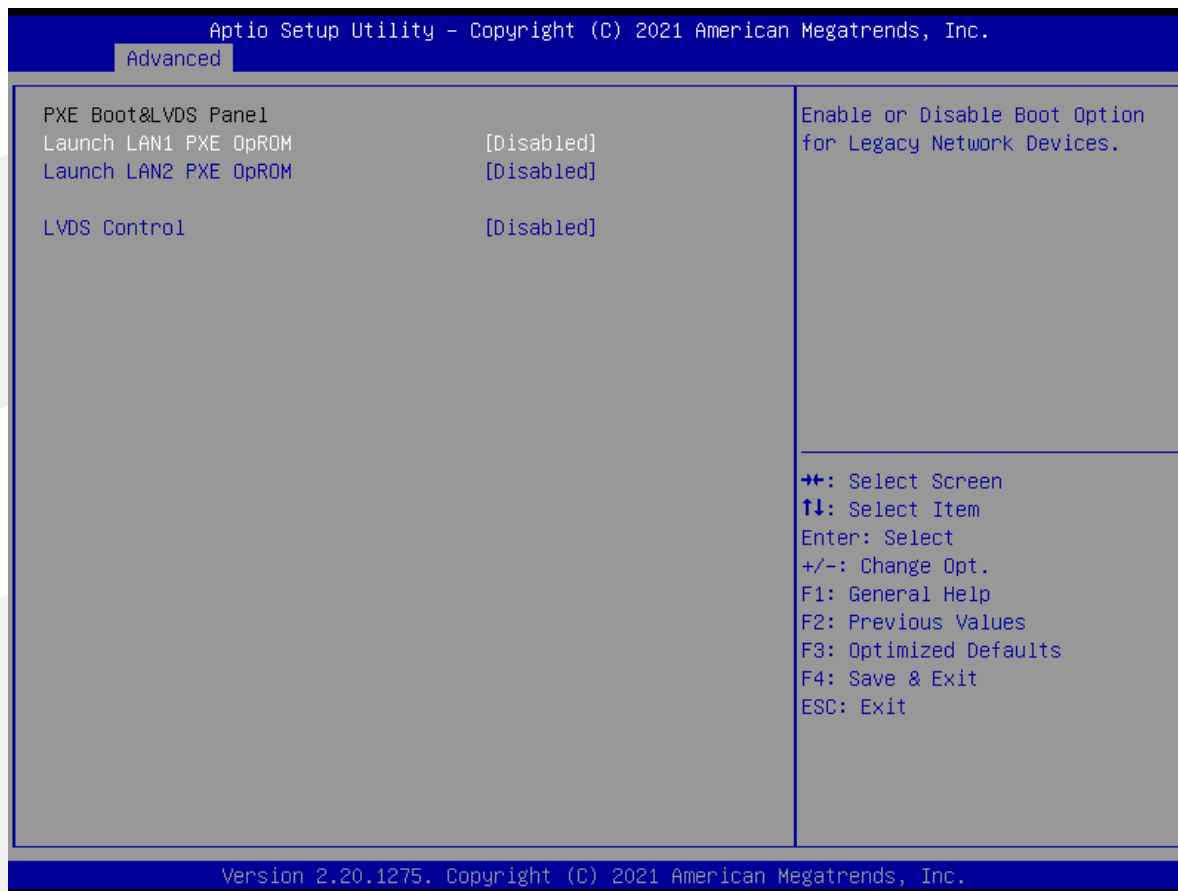

Setup Item	Options	Help Text	Comments
<b>PXE Boot&amp;LVDS Panel</b>			
Launch LAN1 PXE OpROM	Disabled Enabled		Legacy PXE Support Control.
Launch LAN2 PXE OpROM	Disabled Enabled		Legacy PXE Support Control.
LVDS Control	Disabled Enabled		LVDS control.

### 3.3 Chipset Screen

The Chipset screen provides an access point to configure SA Configuration and PCH-IO configuration. To access this screen from the Main screen, press the right arrow until the Chipset screen is chosen.

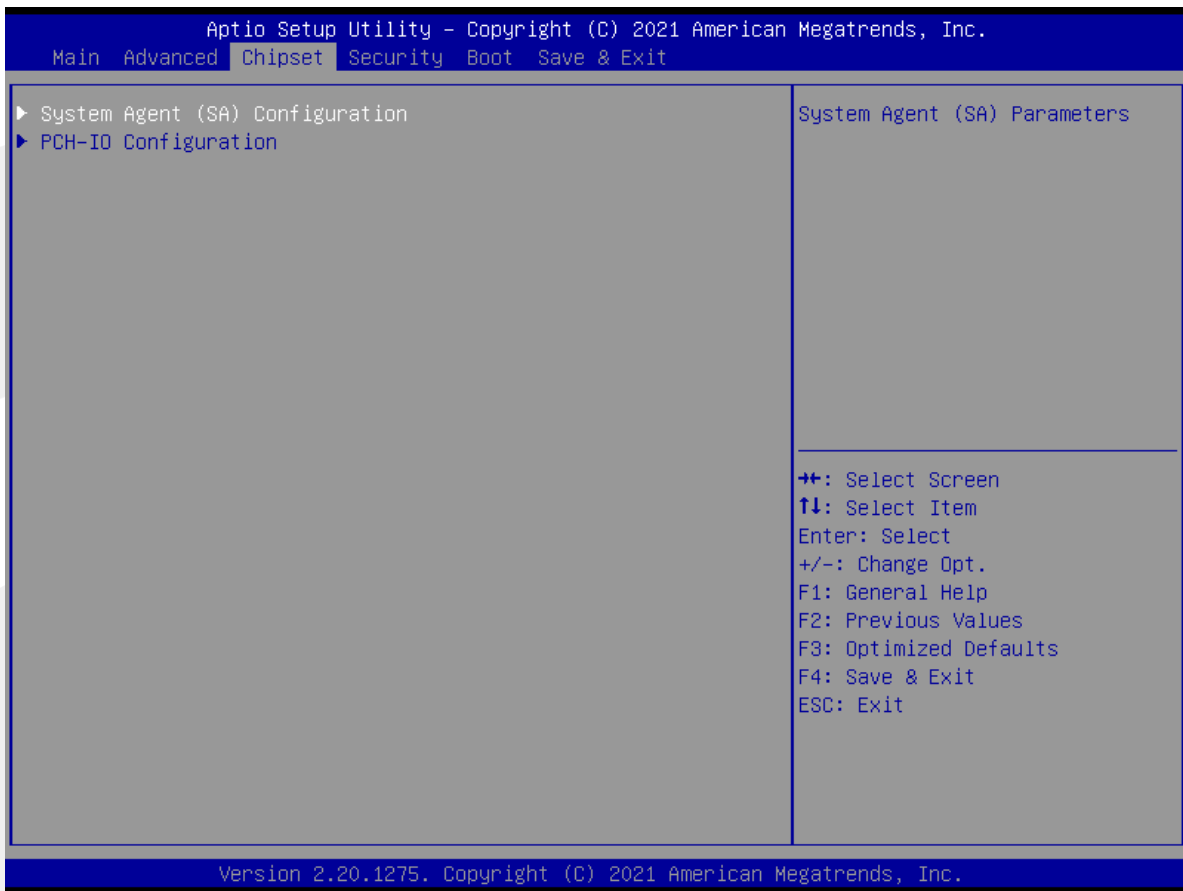

Setup Item	Options	Help Text	Comments
<b>Chipset Screen</b>			
System Agent (SA) Configuration		System Agent (SA) Parameters.	
PCH-IO Configuration		PCH Parameters.	



### 3.3.1 System Agent (SA) Configuration

The North Bridge Screen allows user to set NB chipset configuration. To access this screen, form the Main screen, choose **Chipset > System Agent (SA) Configuration**.



Aptio Setup Utility - Copyright (C) 2021 American Megatrends, Inc.

Chipset

System Agent (SA) Configuration	Memory Configuration Parameters
SA PCIe Code Version VT-d	7.0.110.64 Supported
▶ Memory Configuration	
▶ Graphics Configuration	
▶ PEG Port Configuration	

++: Select Screen  
 ↑↓: Select Item  
 Enter: Select  
 +/-: Change Opt.  
 F1: General Help  
 F2: Previous Values  
 F3: Optimized Defaults  
 F4: Save & Exit  
 ESC: Exit

Version 2.20.1275. Copyright (C) 2021 American Megatrends, Inc.

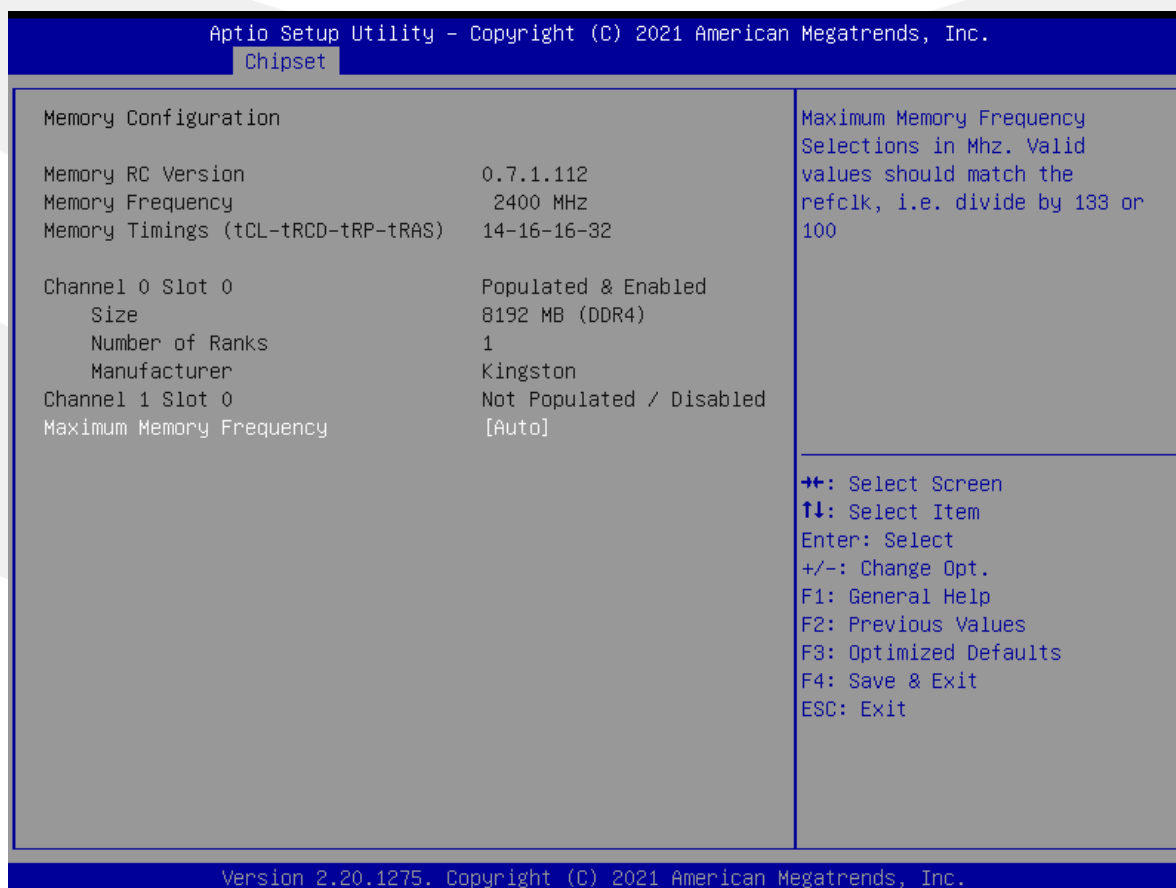

Aptio Setup Utility - Copyright (C) 2021 American Megatrends, Inc.

Chipset

Memory Configuration	Maximum Memory Frequency
Memory RC Version	0.7.1.112
Memory Frequency	2400 MHz
Memory Timings (tCL-tRCD-tRP-tRAS)	14-16-16-32
Channel 0 Slot 0	Populated & Enabled
Size	8192 MB (DDR4)
Number of Ranks	1
Manufacturer	Kingston
Channel 1 Slot 0	Not Populated / Disabled
Maximum Memory Frequency	[Auto]

++: Select Screen  
 ↑↓: Select Item  
 Enter: Select  
 +/-: Change Opt.  
 F1: General Help  
 F2: Previous Values  
 F3: Optimized Defaults  
 F4: Save & Exit  
 ESC: Exit

Version 2.20.1275. Copyright (C) 2021 American Megatrends, Inc.

Aptio Setup Utility - Copyright (C) 2021 American Megatrends, Inc.

Chipset

<p>Graphics Configuration</p> <p>Primary Display [Auto]                  Internal Graphics [Auto]                  GTT Size [8MB]                  Aperture Size [256MB]                  DVMT Pre-Allocated [32M]                  DVMT Total Gfx Mem [256M]                  ▶ LCD Control</p>	<p>Select which of IGFX/PEG/PCI Graphics device should be Primary Display Or select SG for Switchable Gfx.</p> <hr/> <p>←+: Select Screen                  ↑↓: Select Item                  Enter: Select                  +/-: Change Opt.                  F1: General Help                  F2: Previous Values                  F3: Optimized Defaults                  F4: Save &amp; Exit                  ESC: Exit</p>
--	--

Version 2.20.1275. Copyright (C) 2021 American Megatrends, Inc.

Aptio Setup Utility - Copyright (C) 2021 American Megatrends, Inc.

Chipset

<p>PEG Port Configuration</p> <p>PEG 0:1:0 x16 Gen1</p> <p>Enable Root Port [Auto]                  Max Link Speed [Auto]                  Max Link Width [Auto]                  Power Down Unused Lanes [Auto]                  Gen3 Eq Phase 2 [Auto]                  Gen3 Eq Phase 3 Method [Auto]                  ASPM [Auto]                  De-emphasis Control [-3.5 dB]                  OBFF [Enabled]                  LTR [Enabled]                  PEG0 Slot Power Limit Value 75                  PEG0 Slot Power Limit Scale [1.0x]                  PEG0 Physical Slot Number 1</p>	<p>Enable or Disable the Root Port</p> <hr/> <p>←+: Select Screen                  ↑↓: Select Item                  Enter: Select                  +/-: Change Opt.                  F1: General Help                  F2: Previous Values                  F3: Optimized Defaults                  F4: Save &amp; Exit                  ESC: Exit</p>
---	--

Version 2.20.1275. Copyright (C) 2021 American Megatrends, Inc.

Setup Item	Options	Help Text	Comments
<b>System Agent (SA) Configuration</b>			
<b>Memory Configuration</b>			
Memory Information		Show Memory information.	Memory Information.
<b>Graphics Configuration</b>			
Primary Display	Auto		
Internal Graphics	Auto Disabled Enabled	Keep IGFX enabled based on the setup options.	Internal Graphics.
GTT Size	2MB 4MB 8MB	Select the GTT Size.	GTT Size.
Aperture Size	128MB 256MB 512MB 1024MB 2048MB	Select the Aperture Size. Note: Above 4GB MMIO BIOS assignment is automatically enabled when selecting 2048MB aperture. To use this feature, please disable CSM Support.	Aperture Size.
DVMT Pre-Allocated	32M		
DVMT Total Gfx Mem	128M 256M MAX	Select DVMT5.0 Total Graphic Memory size used by the Internal Graphics Device.	DVMT Total Gfx Mem.
LCD Control			
<b>PEG Port Configuration</b>			

### 3.3.2 PCH-IO Configuration

The South Bridge Screen allows user to set SB chipset configuration. To access this screen form the Main screen, choose **Chipset> PCH-IO Configuration**.



Setup Item	Options	Help Text	Comments
<b>PCH-IO Configuration</b>			
State After G3	So State		

### 3.4 Security

To access this screen form the Main screen, choose **Security**.

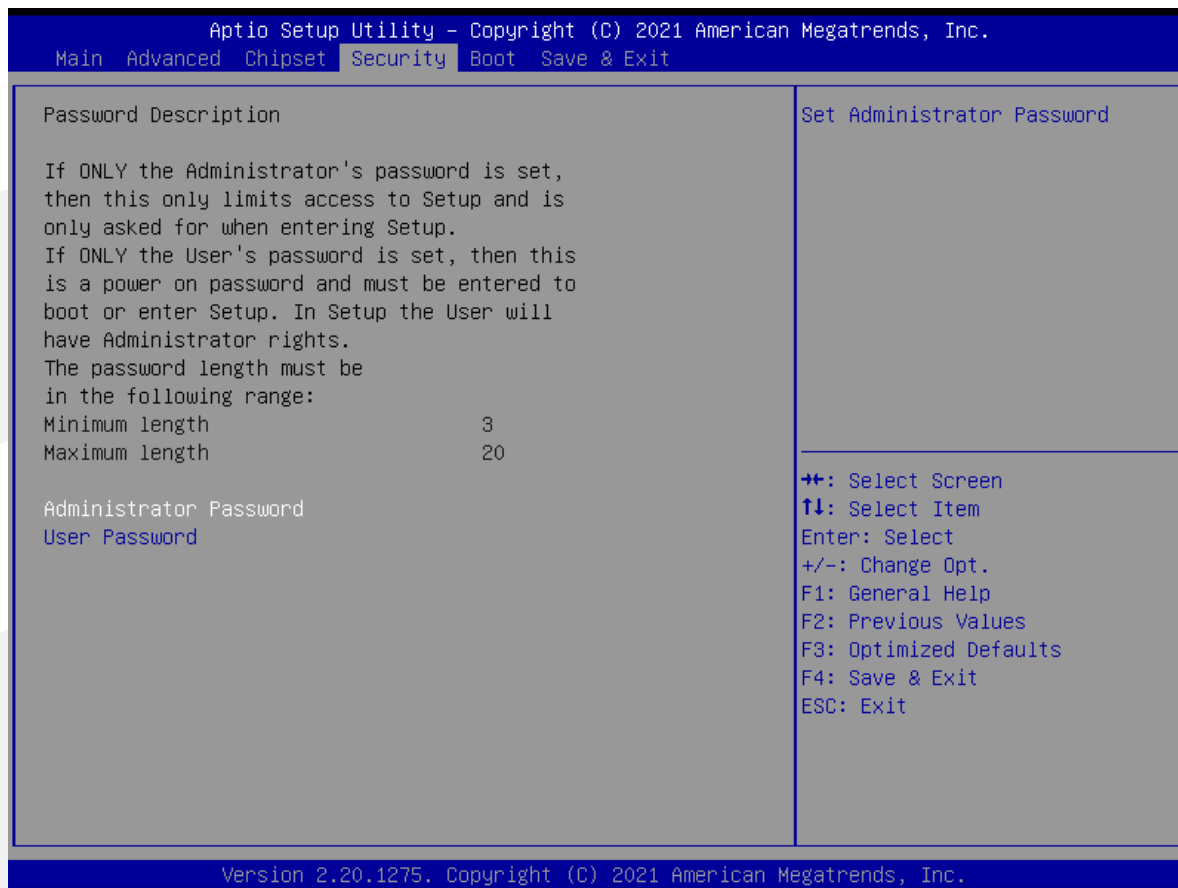

Setup Item	Options	Help Text	Comments
<b>Security</b>			
Administrator Password		Set Administrator Password.	
User Password		Set User Password.	

### 3.5 Boot Screen

The Boot screen displays any bootable media encountered during POST, and allows the user to configure desired boot device. To access this screen from the Main screen, choose **Boot**.

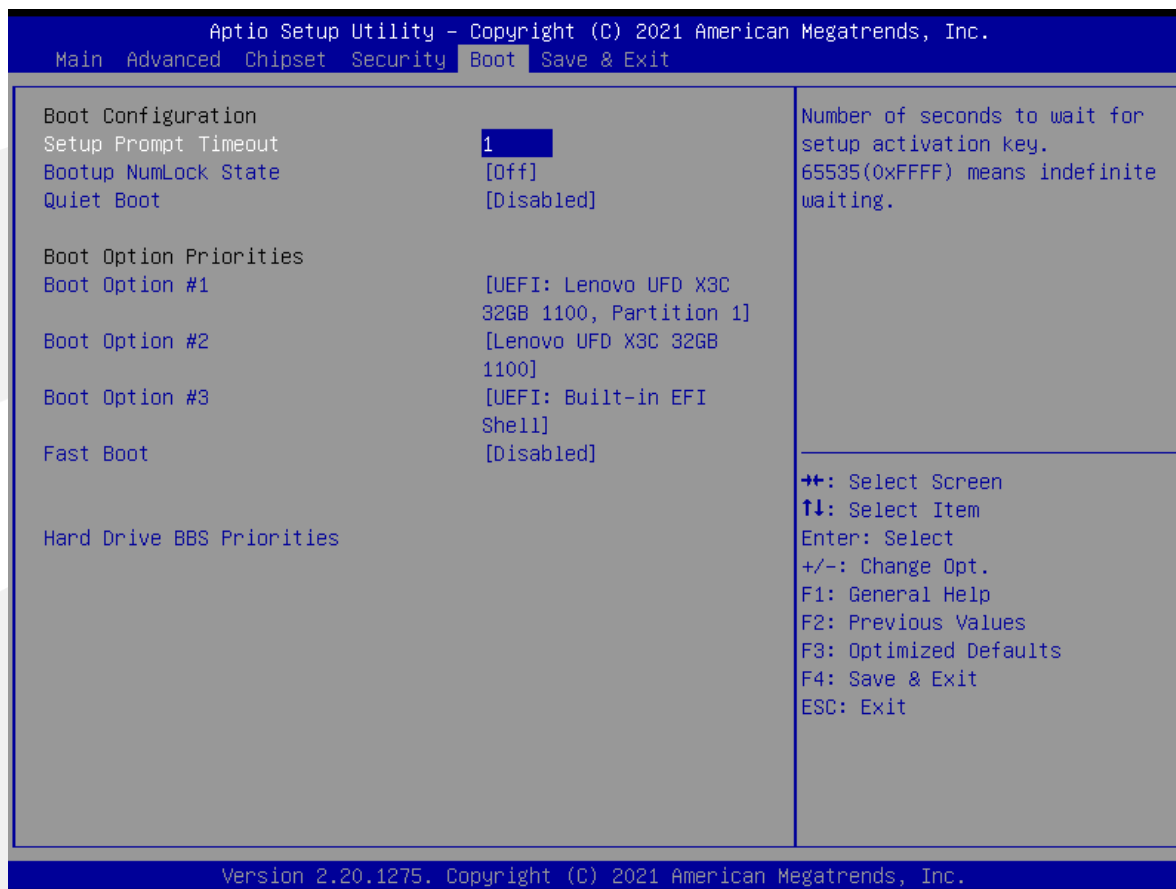

Setup Item	Options	Help Text	Comments
<b>Boot Configuration</b>			
Setup Prompt Timeout	1~65535	Number of seconds to wait for setup activation key.65535(0xFFFF) means indefinite waiting.	
Bootup NumLock State	On off	Select the keyboard Number state.	
Quiet Boot	Disabled Enabled	Enables or disables Quiet Boot option.	
<b>Boot Option Priorities</b>			
Boot Option #1		Sets the system boot order.	Note : Showed When boot devices existed.
Boot Option #2		Sets the system boot order.	
Boot Option #3		Sets the system boot order.	
Fast Boot	Disabled		
Hard Drive BBS Priorities		Set the order of the legacy devices in this group.	Set boot order in each group of the same kind, such as HDD, network.

### 3.6 Save & Exit Screen

The Save & Exit screen allows the user to choose whether to save or discard the configuration changes made on the other screens. It also allows the user to restore the server to the factory defaults or to save or restore them to set of user-defined default values.

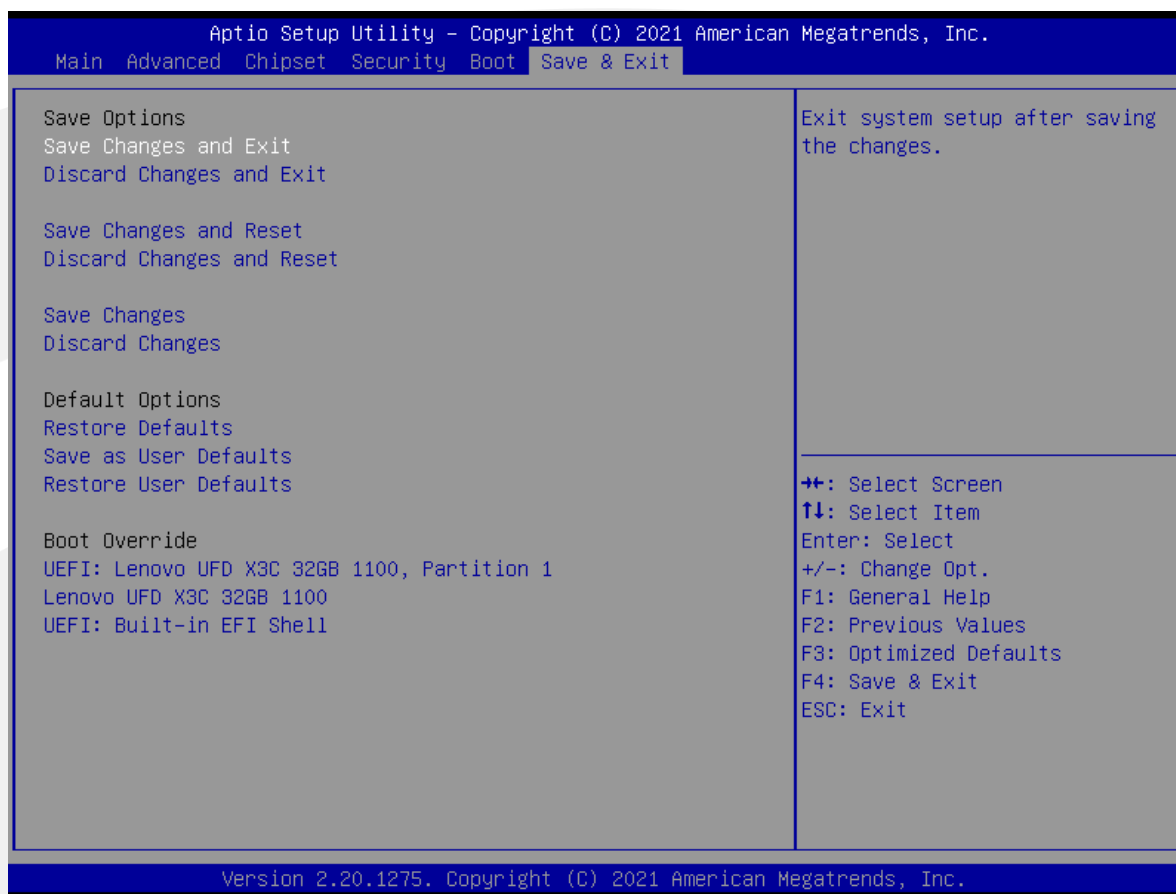

Setup Item	Options	Help Text	Comments
<b>Save &amp; Exit Screen</b>			
Save Changes and Exit		Exit system setup after saving the changes.	User is prompted for confirmation only if any of the setup fields were modified.
Discard Changes and Exit		Exit system setup without saving any changes.	
Save Changes and Reset		Reset the system after saving the changes.	
Discard Changes and Reset		Reset system setup without saving and changes.	
<b>Default Options</b>			
Restore Defaults		Restore/Load Default values for all the setup options.	
Save as User Defaults		Save the changes done so far as User Defaults.	
Restore User Defaults		Restore the User Defaults to all the setup options.	
<b>Boot Override</b>			

Setup Item	Options	Help Text	Comments
Shows the Device can boot.			Note : Showed When boot devices existed.

## 第四章 故障问题排除

故障	排除
关闭来电自启	BIOS 下设置： BIOS—chipset—PCH-IO—S5 State
解决内置 HDMI 进系统黑屏与不支持热插拔	把内置 HDMI 与外置 HDMI 同时接上显示器,然后正常安装显卡驱动



## 附录

### 附一：术语表

#### ACPI

高级配置和电源管理。ACPI 规范允许操作系统控制计算机及其附加设备的大部份电能。

#### BIOS

基本输入/输出系统。是在 PC 中包含所有的输入/输出控制代码界面的软件。它在系统启动时进行硬件检测，开始操作系统的运作，在操作系统和硬件之间提供一个界面。BIOS 是存储在一个只读存储器芯片内。

#### BUS

总线。在计算机系统中，不同部件之间交换数据的通道，是一组硬件线路。我们所指的 BUS 通常是 CPU 和主内存元件内部的局部线路。

#### Chipset

芯片组。是为执行一个或多个相关功能而设计的集成芯片。我们指的是由南桥和北桥组成的系统级芯片组，他决定了主板的架构和主要功能。

#### CMOS

互补金属-氧化物半导体。是一种被广泛应用的半导体类型。它具有高速、低功耗的特点。我们指的 CMOS 是在主板上的 CMOS RAM 中预留的一部份空间，用来保存日期、时间、系统信息和系统参数设定信息等。

#### COM

串口。一种通用的串行通信接口，一般采用标准 DB9 公头接口连接方式。

#### DIMM

双列直插式内存模块。是一个带有内存芯片组的小电路板。提供 64bit 的内存总线宽度。

#### DRAM

动态随机存取存储器。是一个普通计算机的通用内存类型。通常用一个晶体管和一个电容来存储一个位。随着技术的发展，DRAM 的类型和规格已经在计算机应用中变得越来越多样化。例如现在常用的就有 SDRAM、DDR SDRAM 和 RDRAM。

#### L2c

Inter-Integrated Circuit 总线是一种由 PHILIPS 公司开发的两线式串行总线，用于连接微控制器及其外围设备。

#### LAN

局域网络接口。一个小区域内相互关联的计算机组成的一个计算机网络，一般是在一个企事业单位或一栋建筑物。局域网一般由服务器、工作站、一些通信链接组成，一个终端可以通过电线访问数据和设备的任何地方，许多用户可以共享昂贵的设备和资源。

## LED

发光二极管，一种半导体设备，当电流流过时它会被点亮，通常用来把信息非常直观地表示出来，例如表示电源已经导通或硬盘驱动器正在工作等。

## PnP

即插即用。允许 PC 对外接设备进行自动配置，不用用户手动操作系统就可以自己工作的一种规格。为实现这个特点，BIOS 支持 PnP 和一个 PnP 扩展卡都是必需的。

## POST

上电自检。在启动系统期间，BIOS 会对系统执行一个连续的检测操作，包括检测 RAM，键盘，硬盘驱动器等，看它们是否正确连接和是否正常工作。

## PS/2

由 IBM 发展的一种键盘和鼠标连接的接口规范。PS/2 是一个仅有 6PIN 的 DIN 接口，也可以用以连接其他的设备，比如调制解调器。

## USB

通用串行总线。一种适合低速外围设备的硬件接口，一般用来连接键盘、鼠标等。一台 PC 最多可以连接 127 个 USB 设备，提供一个 12Mbit/s 的传输带宽；USB 支持热插拔和多数数据流功能即在系统工作时可以插入 USB 设备，系统可以自动识别并让插入的设备正常。

深圳智锐通科技有限公司  
Shenzhen Zrt Co., Ltd.



智锐通公众号

&



智锐通抖音号

- 集团总部：深圳市宝安区碧桂园凤凰智谷A栋21楼
- 北京分公司：北京市昌平区科兴西路106号院2号楼5层
- 南京分公司：南京市江宁区万科都荟天地B2栋7楼
- 苏州分公司：苏州市虎丘区港龙城市广场4栋13楼
- 成都分公司：成都市武侯区世纪百合尚寓3栋10楼
- 400-838-6869