

MIN-EC05B

ZRT-Q370B

USER'Manual V1.0

用户手册

USER'Manual

声明

本使用说明书内容如有变更，恕不另行通知。

本公司并不对本使用说明书之适用性，适合做某种特殊用途之使用或其他任何事项做任何明示，或做其他形式之保证或担保。因此本公司将不对手册内容之错误，或因增减展示或以其他方法使用本手册所造成之直接，间接，突发性过、或继发性之损害负任何责任。

版权声明：

版权所有----深圳智锐通科技有限公司

未经本公司许可或依著作权法之规定许准，不得复制，节录和翻译使用说明书之任何内容。

目录

第一章 产品介绍.....	1
1.1 产品规格.....	1
1.2 设计原理框图.....	2
第二章 安装说明.....	3
2.1 接口和尺寸图.....	3
2.2 硬件安装.....	4
2.3 跳线功能设置.....	4
2.3.1 清 CMOS 跳线设置.....	5
2.4 插针定义说明.....	5
2.4.1 串口插针定义.....	5
2.4.2 JLPC: 诊断卡插针.....	5
2.4.3 GPIO 插针.....	5
2.5 接口说明.....	6
2.5.1 SATA 接口.....	6
2.5.2 风扇座子.....	7
2.5.3 串行接口 (DB9 接口).....	7
2.5.4 显示接口.....	8
2.5.5 网络接口.....	8
2.5.6 USB 接口.....	8
2.5.7 音频接口.....	9
2.5.8 Mini PCIE 卡槽.....	9
2.6 开机、重启、一键还原按钮.....	9
2.6.1 主板按键说明.....	9
第三章 BIOS 程序设置.....	10
一、Setup Utility User Interface.....	错误!未定义书签。
1.1 Main Screen.....	错误!未定义书签。
1.2 Advanced Screen.....	错误!未定义书签。
1.2.1 CPU Configuration Screen.....	错误!未定义书签。
1.2.2 ACPI Settings Screen.....	错误!未定义书签。
1.2.3 GPIO Setting & Status.....	错误!未定义书签。
1.2.4 Super IO Configuration.....	错误!未定义书签。
1.2.4.1 Serial PortX Configuration.....	错误!未定义书签。
1.2.5 Hardware Monitor.....	错误!未定义书签。
1.2.6 PXE Boot.....	错误!未定义书签。
1.2.7 CSM Configuration.....	错误!未定义书签。
1.2.8 NVMe Configuration.....	错误!未定义书签。
1.2.9 SATA Configuration.....	错误!未定义书签。
1.2.10 USB Configuration.....	错误!未定义书签。
1.3 Chipset Screen.....	错误!未定义书签。
1.3.1 System Agent (SA) Configuration.....	错误!未定义书签。
1.3.1.1 Memory Configuration.....	错误!未定义书签。
1.3.1.2 Graphics Configuration.....	错误!未定义书签。

1.3.1.3 PEG Port Configuration	错误!未定义书签。
1.3.2 PCH-IO Configuration	错误!未定义书签。
1.4 Security	错误!未定义书签。
1.5 Boot Screen	错误!未定义书签。
1.6 Save & Exit Screen	错误!未定义书签。
第四章 产品结构图	
4.1 产品尺寸图	
4.2 装配示意图一	
4.3 装配示意图二	
附录	38
附表：术语表.....	39

安全须知

警告：

1. 产品使用前，务必仔细阅读产品说明书。
2. 对未准备安装的板卡，应将其保存在防静电保护袋中。
3. 在从包装袋中拿板卡前，应将手先置于接地金属物体上一会儿，以释放身体及手中的静电。
4. 在拿板卡时，需佩戴静电保护手套，并且应该养成只触及其边缘部份的习惯。
5. 主板与电源连接时，请确认电源电压。
6. 为避免人本被电击或产品被损坏，在每次对主板、板卡进行拔插或生新配置时，须先关闭交流电源或将交流电源线从电源插座中拔掉。
7. 在对板卡进行搬动前，先将交流电源线从电源插座中拔掉。
8. 当您需连接或拔除任何设备前，须确定所有的电源线事先已被拔掉。
9. 为避免频繁开关机对产品造成不必要的损伤，关机后，应至少等待 30 秒后再开机。
10. 设备在使用过程时出现异常情况，请找专业人员处理。

第一章 产品介绍

1.1 产品规格

ZRT-Q370B

处理器	■支持八代 Intel Coffee lake S I3/I5/I7 处理器，同时兼容第九代 CPU。
芯片组	■Intel Q370 平台。
BIOS	■128Mbit AMI EFI BIOS。 ■支持一键还原。
显示	■集成显卡 HDMI，独立显卡 HDMI/DP。
系统内存	■2 个 SO-DIMM DDR4 内存插槽； ■最高支持 32G DDR4 2666 MHZ。
存储	■支持 1 个 7Pin SATA 速度支持 3.0 Gb/s 和 1.5 Gb/s ■支持 2242/2280 PCIe SSD。
LAN 功能	■支持 2 个 Intel® i211AT 千兆以太网接口。
WLAN 功能	■支持一个 M.2 WIFI ■支持一个 4G/5G 模块
USB 接口	■支持 4 个 USB 2.0(座子)和 2 个 USB2.0 (插针) ■支持4个USB 3.0(前面板座子)和2个USB3.0 (后面板座子)。
串口	■支持2个DB9接口 (RS-232/RS485)，可以通过跳帽切换RS-232/RS485。 ■4个2*5插针COM (RS232)
GPIO 接口	■支持 1 个 4 进 4 出的 GPIO 接口(凤凰端子)。 ■支持 1 个 4 进 4 出的 GPIO 接口 (插针)
电源支持	■支持 1 个 4 PIN 凤凰端子输入接口 (19/24v) ■ 1 个 2PIN 的 12V 电源输出接口 (12V/1A)
尺寸	■支持 200mm (L)* 200mm (W)。
工作环境	■支持工作温度：-10℃~60℃

■支持工作湿度：0~95%

1.2 设计原理框图

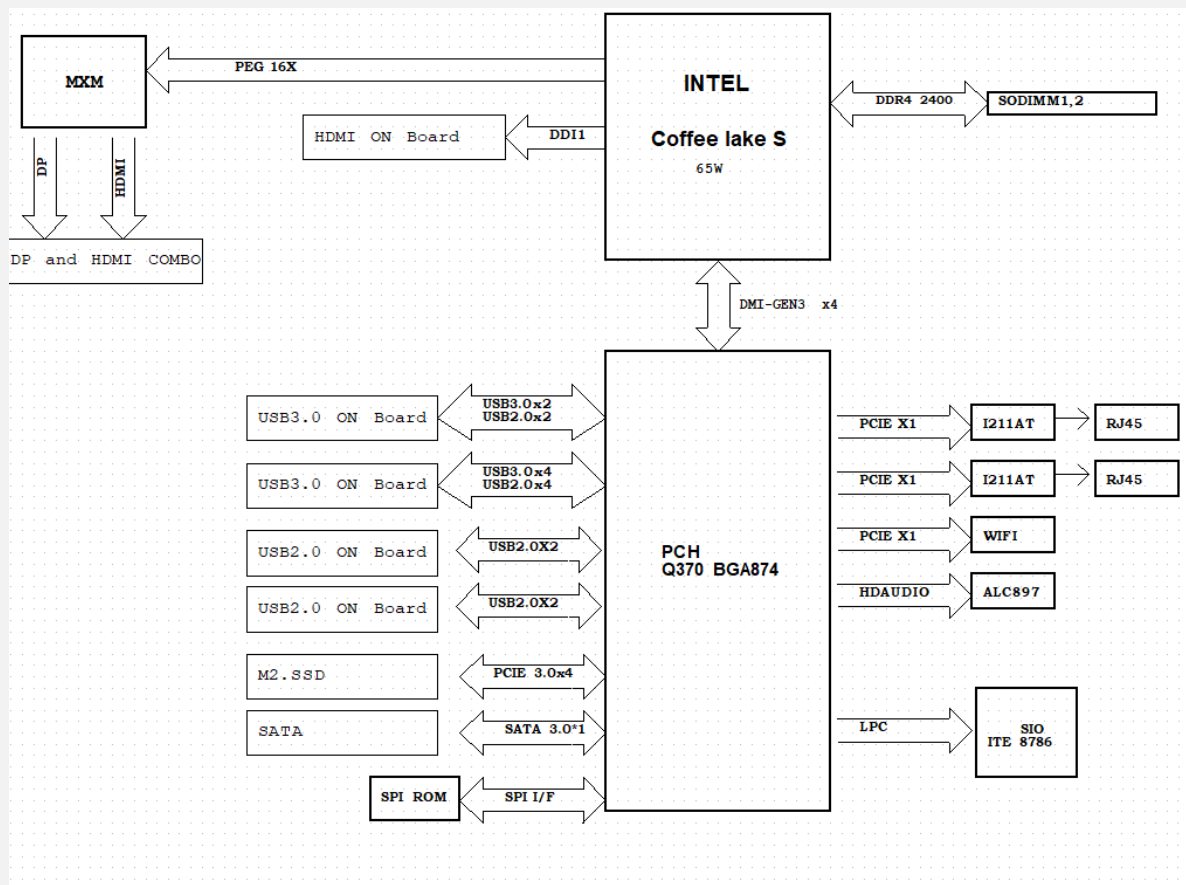

第二章 安装说明

2.1 接口和尺寸图

下图为 Q370B 的尺寸图。安装设备时，请对照此示意图并仔细阅读下面的说明，安装组件过程中必须小心，对于有些部件，如果安装不正确，设备将不能正常工作。

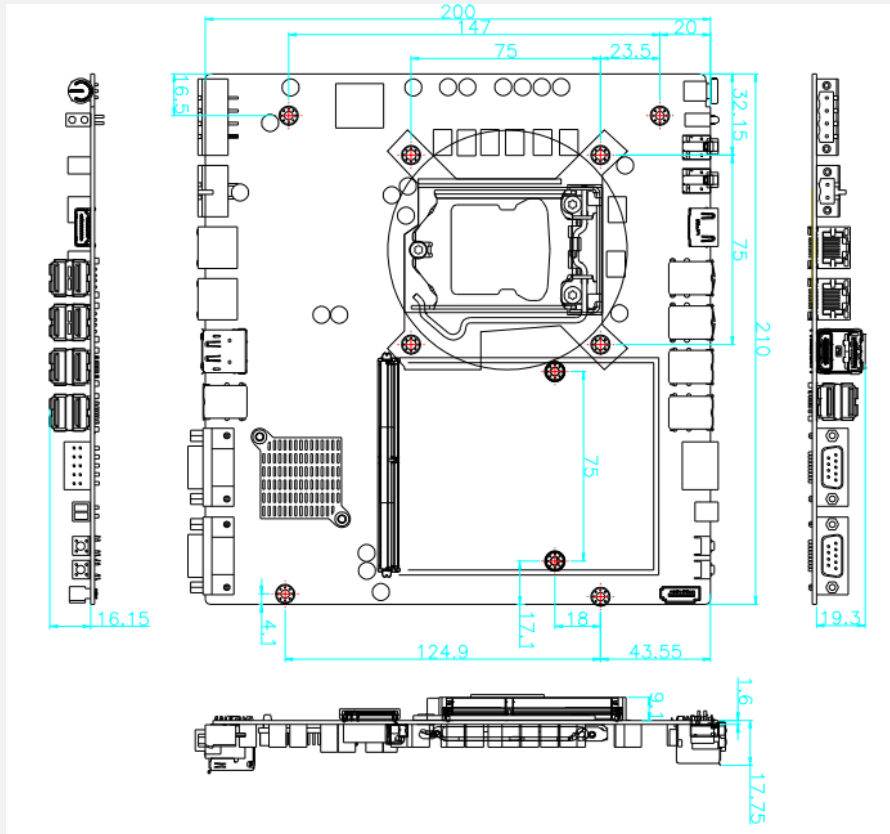

EZT-Q370B VER1.0 Mechanical Drawing (TOP Side)

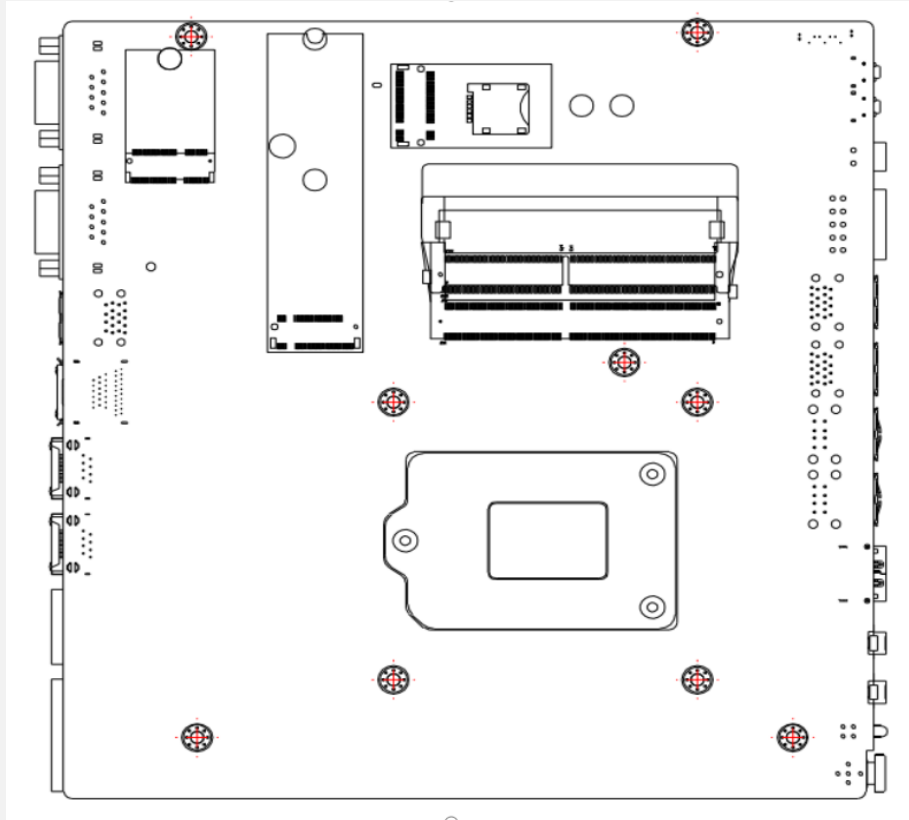

EZT-Q370B VER1.0 Mechanical Drawing (Bottom Side)

2.2 硬件安装

⚠注意：操作时，请戴上防静电手套，因为静电有可能会损坏部件。

本主板关键元器件都是集成电路，而这些元件很容易因为遭受静电的影响而损坏。因此，请在正式安装主板之前，请先做好以下的准备：

1. 拿主板时手握板边，尽可能不触及元器件和插头插座的引脚。
2. 接触集成路元件（如 CPU、RAM 等）时，最好戴上防静电手环/手套。
3. 在集成电路元件未按装前，需将元件放在防静电垫或防静电袋内。
4. 在确认电源的开关处于断开位置后，再插上电源插头。

2.3 跳线功能设置

在进行硬件设备安装之前请按照您的需要对相应的跳线进行设置。

提示：如何识别跳线、接口的第 1 针脚，观察插头插座旁边的文字标记，会用“1”或加粗的线条或三角符号表示；看看背面的焊盘，方型焊盘为第 1 针脚；所有跳线的针脚 1 旁都有 1 个白色箭头。

2.3.1 清 CMOS 跳线设置

主板提供插针 CLR_CMOS1 来清 CMOS，如下图：

CLR_CMOS1 插针定义如下：

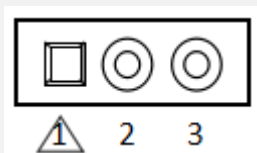

选择模式	跳冒
不清除 CMOS (默认)	1-2
清除 CMOS	2-3

2.4 插针定义说明

2.4.1 串口插针定义

COM3, COM4, COM5, COM6 为 RS232 模式, PIN 定义如下：

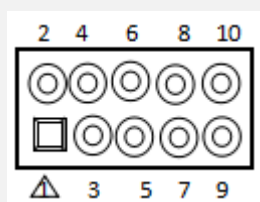

Pin	Signal	Pin	Signal
1	DCD	2	RXD
3	TXD	4	DTR
5	GND	6	DSR
7	RTS	8	CTS
9	RI	10	NC

2.4.2 JLPC1: 诊断卡插针

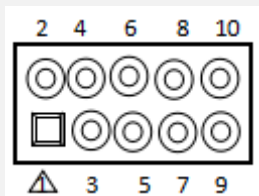

Pin	Signal	Pin	Signal
1	AD0	2	CLK
3	AD1	4	RST
5	AD2	6	FRAME
7	AD3	8	3.3VS
9	SERIRQ	10	GND

2.4.3 GPIO 插针

GPI02 插针定义

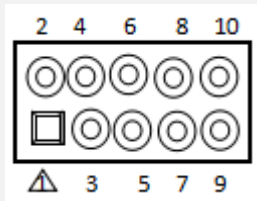

Pin	Signal	Pin	Signal
1	IN0	2	IN1
3	IN2	4	IN3
5	IN4	6	IN5
7	IN6	8	IN7
9	GND	10	VCC (3.3V or 5V)

2.4.4 USB 插针

USB20_1 为 USB 2.0 插针

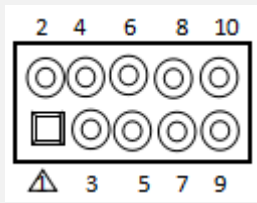

Pin	Signal	Pin	Signal
1	5V	2	5V
3	USB2_N1	4	USB2_N2
5	USB2_P1	6	USB2_P2
7	GND	8	GND
9	NC	10	GND

2.5 接口说明

2.5.1 SATA 接口

SATAPWR1 :电源插座

Pin	Signal	Pin	Signal
1	12VS	2	GND
3	GND	4	5V

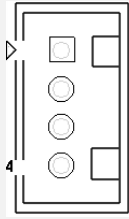

SATA1 :7PIN 数据座

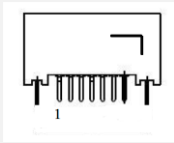

Pin	Signal	Pin	Signal
1	GND	2	SATA_TX_P
3	SATA_TX_N	4	GND
5	SATA_RX_N	6	SATA_RX_P
7	GND		

2.5.2 风扇座子

MXMO_FAN1, MXM1_FAN1, CPU_FAN1 4PIN 风扇座子, PIN 定义如下:

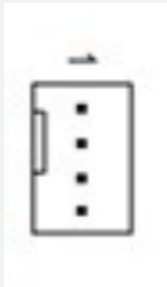

Pin	Signal	Pin	Signal
1	GND	2	12VS
3	TAC	4	CTL

2.5.3 串行接口 (DB9 接口)

COM1, COM2 接口定义

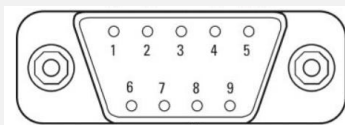

Pin	Signal
1	DCD#
2	RXD
3	TXD
4	DTR#
5	GND
6	DSR#
7	RTS#

8	CTS#
9	RI#

2.5.4 显示接口

主板含有集成显卡HDMI输出，独立显卡HDMI/DP输出

接口列表

显示接口位号	显示类型	输出通道	备注
J11	HDMI	核显通道	标准显示接口
HDMI1-UP	DP	独显通道	标准显示接口
HDMI1-DN	DHMI	独显通道	标准显示接口

2.5.5 网络接口

主板提供 2 个 Intel i211 10/100/1000M 自适应以太网接口 LAN1, LAN2, 标准 RJ45 网络接口

2.5.6 USB 接口

1: 单板提供 4 个标准 USB3.0 接口 USB2: 双层 USB3.0
 USB3: 双层 USB3.0

2: 单板提供 4 个标准 USB2.0 接口 USB3: 双层 USB2.0
 USB4: 双层 USB2.0

2.5.7 音频接口

主板支持一路 3.5mm 三段式 MIC_IN1 输入 和 一路 3.5MM 三段式 front_spk1 输出

2.5.8 M.2 PCIE 卡槽

主板支持一个 M.2_E_CONN 卡槽，接口类型为 B_KEY ，支持 WiFi,蓝牙

主板支持一个 4G1 卡槽 ， 接口类型为 B_KEY，支持 4G/5G 模块。

主板支持一个 NGFF1 卡槽 ， 接口类型为 M_KEY 接口,支持 4XPCIE&SATA 协议

2.6 开机、重启、一键还原按钮

2.6.1 主板按键说明

开机按钮，复位按钮，一键还原按钮

开机按钮 SW1:

Pin	Signal	Pin	Signal
1	PWR_SW	2	GND
3	LED+	4	LED-

复位按钮 SW2 :

Pin	Signal	Pin	Signal
1	RST_SW	2	NC
3	GND	4	NC

一键还原按钮 SW4:

Pin	Signal	Pin	Signal
1	ONEKEY_SW	2	NC
3	GND	4	NC

第三章 BIOS 程序设置

BIOS 描述

开机时，BIOS 会对主板上的硬件进行自我诊断，设定硬件时序参数等工作，最后才将系统控制权交给操作系统。BIOS 是硬件和软件的沟通桥梁，如何正确的设定 BIOS 参数对系统是否稳定的工作及系统是否工作在最佳状态至关重要。

BIOS 基础操作规范：

电脑开机，在完成自我诊断后，屏幕上会显示出如下信息：Del->SETUP，此时您点击一下 Del 键，则 BIOS 在完成 IDE 等设备的侦测后会自动转入 SETUP 设置画面。

1. 打开系统电源或重新启动系统，显示器屏幕将出现自我测试的信息；
2. 当屏幕中间出现“Pressto enter setup”提示时，按下键，就可以进入 BIOS 设定程序；
3. 以方向键移动至你要修改的选项，按下<Enter>键即可进入该选项的子画面；
4. 使用方向键及<Enter>键即可修改所选项目的值，按回车键选择 BIOS 选项并修改；
5. 任何时候按下<Esc>键即可回到上一画面。

BIOS 详细参数设置

Setup Utility User Interface

This document describes BIOS Setup Utility user interface.

1.1 Main Screen

The Main screen is the first screen that is displayed when the BIOS Setup is entered.

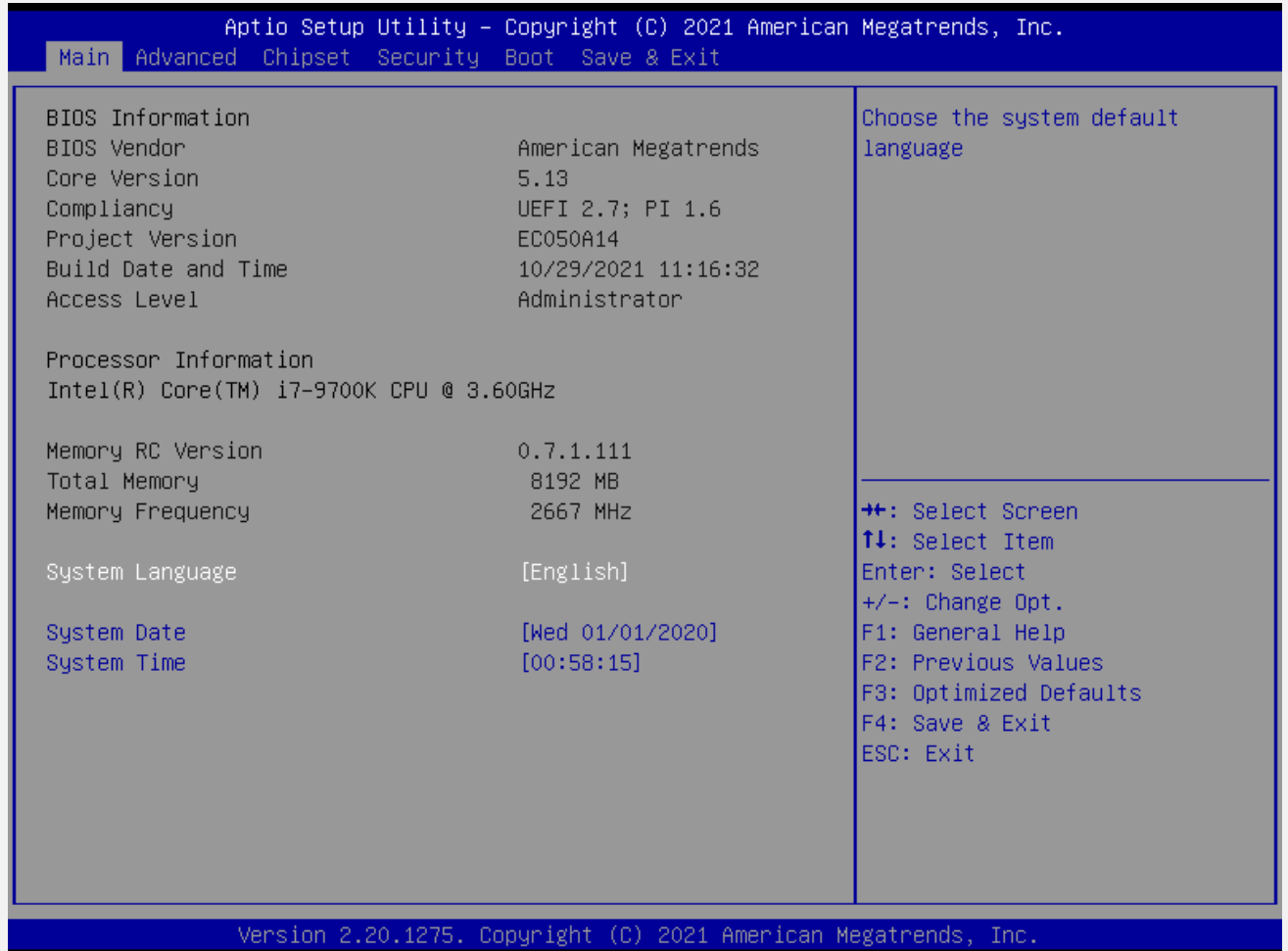

Setup Item	Options	Help Text	Comments
BIOS Information			
BIOS Vendor			Displays BIOS vendor
Project Version			Displays the current BIOS version: Format: AAAABBC AAAAA = Project name BB = BIOS revision C = Customer number
Build Date and Time			Displays the current BIOS build date.

Setup Item	Options	Help Text	Comments
Access Level			Displays password level that setup is running in: Administrator or User. With no passwords set, Administrator is the default mode.
Process Information			
CPU XXXXX			Displays the CPU BrandString installed in the system
Memory Information			
Total Memory			Displays the total physical memory installed in the system, MB Unit
Memory Frequency			
System Language	English	Choose the system default language	
System Date	[Day of week MM/DD/YYYY]	Set and display the Date..	
System Time	[HH:MM:SS]	Set and display the Time.	

1.2 Advanced Screen

The Advanced screen provides an access point to configure several options. On this screen, the user selects the option that is to be configured.

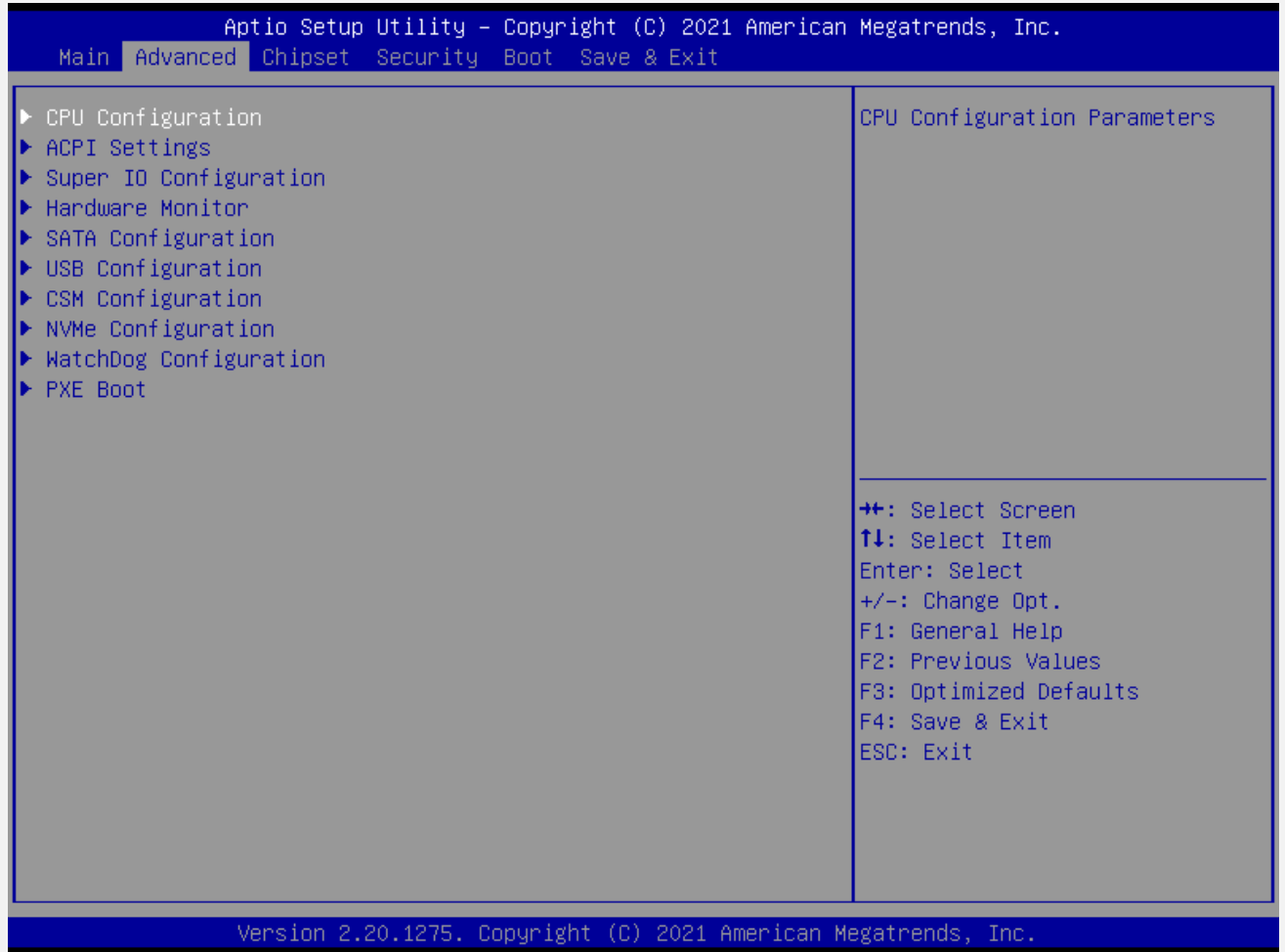

Setup Item	Options	Help Text	Comments
CPU Configuration		CPU Configuration Parameters	
ACPI Settings		System ACPI Parameters	
Super IO Configuration		System Super IO chip Parameters	
HW Monitor		Monitor hardware stats	
SATA Configuration		SATA Devices Configuration	
USB Configuration		USB Configuration Parameters.	
CSM Configuration		CSM configuration: Enable/Disable, Option ROM execution settings, etc.	
NVMe Configuratioin		NVMe Device Options Settings	
Watchdog configuration		Set System WatchDog Parameters.	
PXE Boot		Legacy PXE Control	

1.2.1 CPU Configuration Screen

The CPU Configuration screen allows the user to view the processor information, and to enable or disable processor options. To access this screen from the Main screen, choose **Advanced > CPU Configuration**.



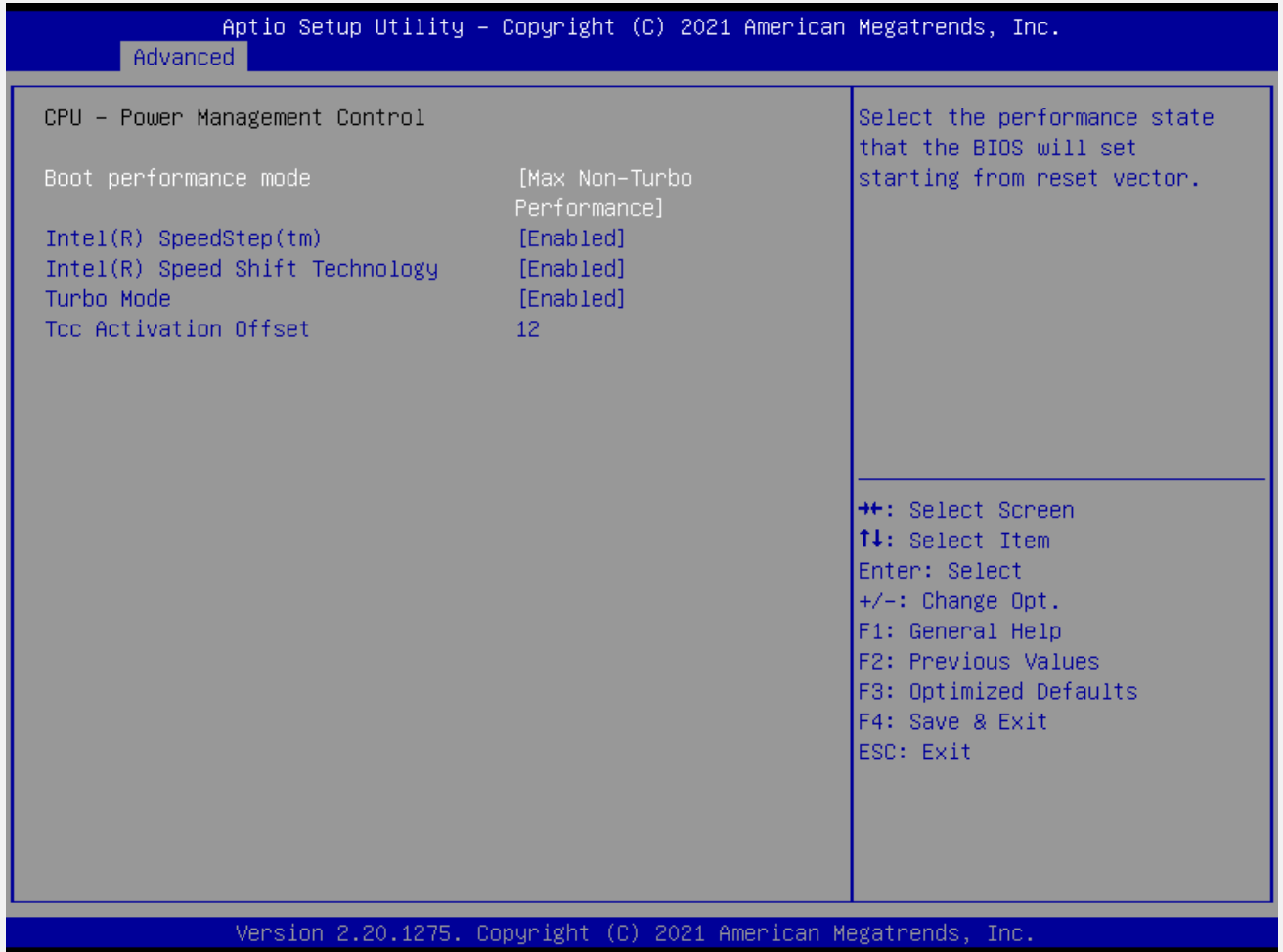

Setup Item	Options	Help Text	Comments
CPU Configuration			
CPU Speed			
VMX			
SMX/TXT			
Hardware Prefetcher	Enabled Disabled	To turn on/off the MLC streamer prefetcher	
Adjacent Cache line Prefetch	Enabled Disabled	To turn on/off prefetching of adjacent cache lines	
Intel(VMX) Technology	Enabled Disabled	When enabled,a VMM can utilize the additional hardware capabilities provided by vanderpool technology	
Active Processor Cores	All 1 2 3	Number of cores to enable in each processor package	

Setup Item	Options	Help Text	Comments
CPU Power Management control			
Boot performance mode	Max Non-Turbo Max battery Turbo Performance	Select the performace state that the BIOS will set starting from reset vector	
Intel® speedStep™	Enabled Disabled	Allows more than two frequency ranges to be supported	
Intel® speed shift technology	Enabled Disabled	Enable/Disable Intel® speed shift technology support	

1.2.2 ACPI Settings Screen

The ACPI Settings screen allows the user to set the system ACPI parameters. To access this screen from the Main screen, choose **Advanced > ACPI Settings**.

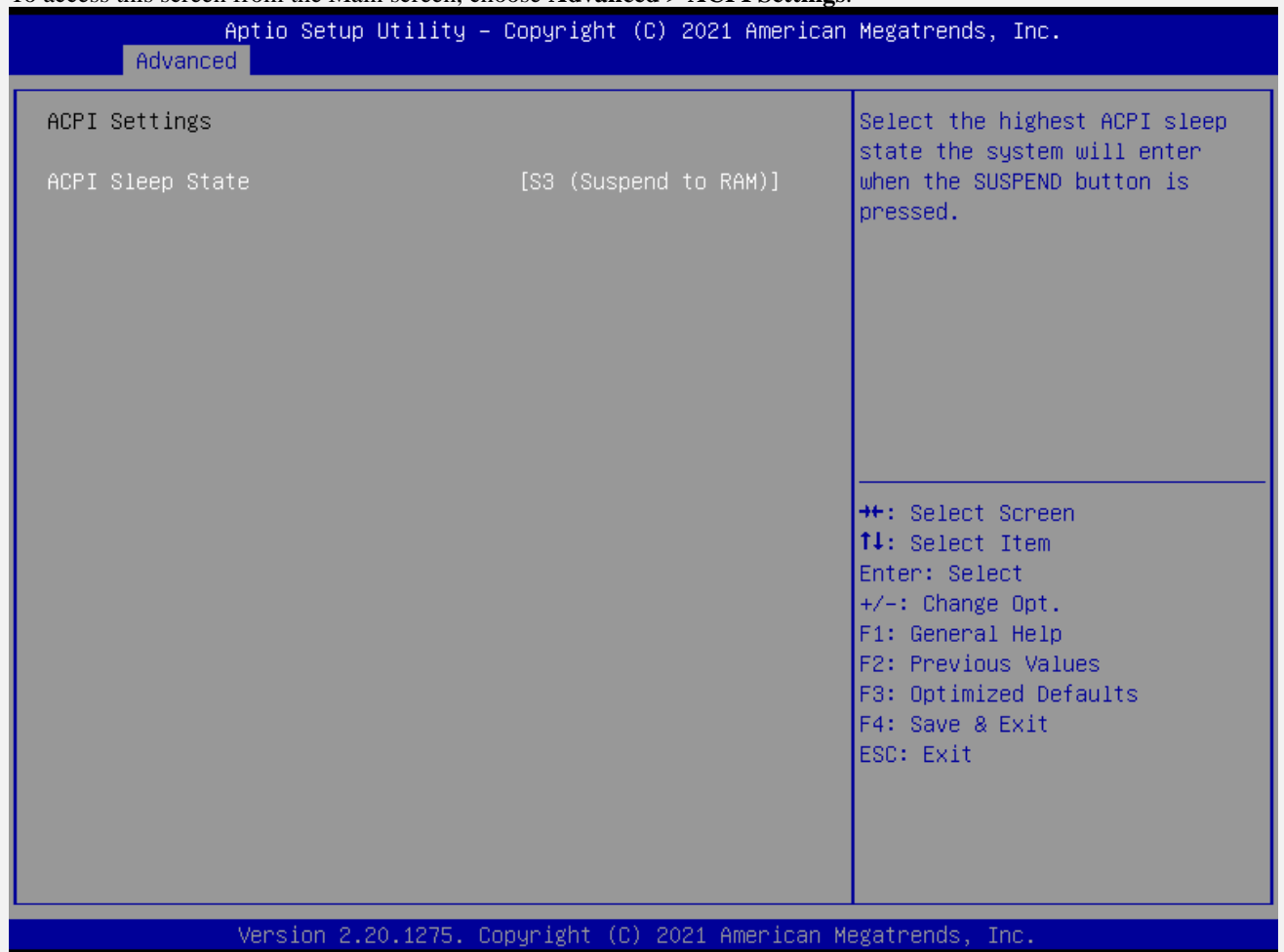

Setup Item	Options	Help Text	Comments
ACPI Sleep State	Suspend Disabled S3 (Suspend to RAM)	Select the highest ACPI sleep state the system will enter when the SUSPEND button is pressed.	Sleep supported optionally.

1.2.3 Super IO Configuration

The Super IO Configuration screen allows the user to view the super IO information, and to enable or disable super IO options. To access this screen from the Advanced screen, choose **Advanced > Super IO Configuration**.

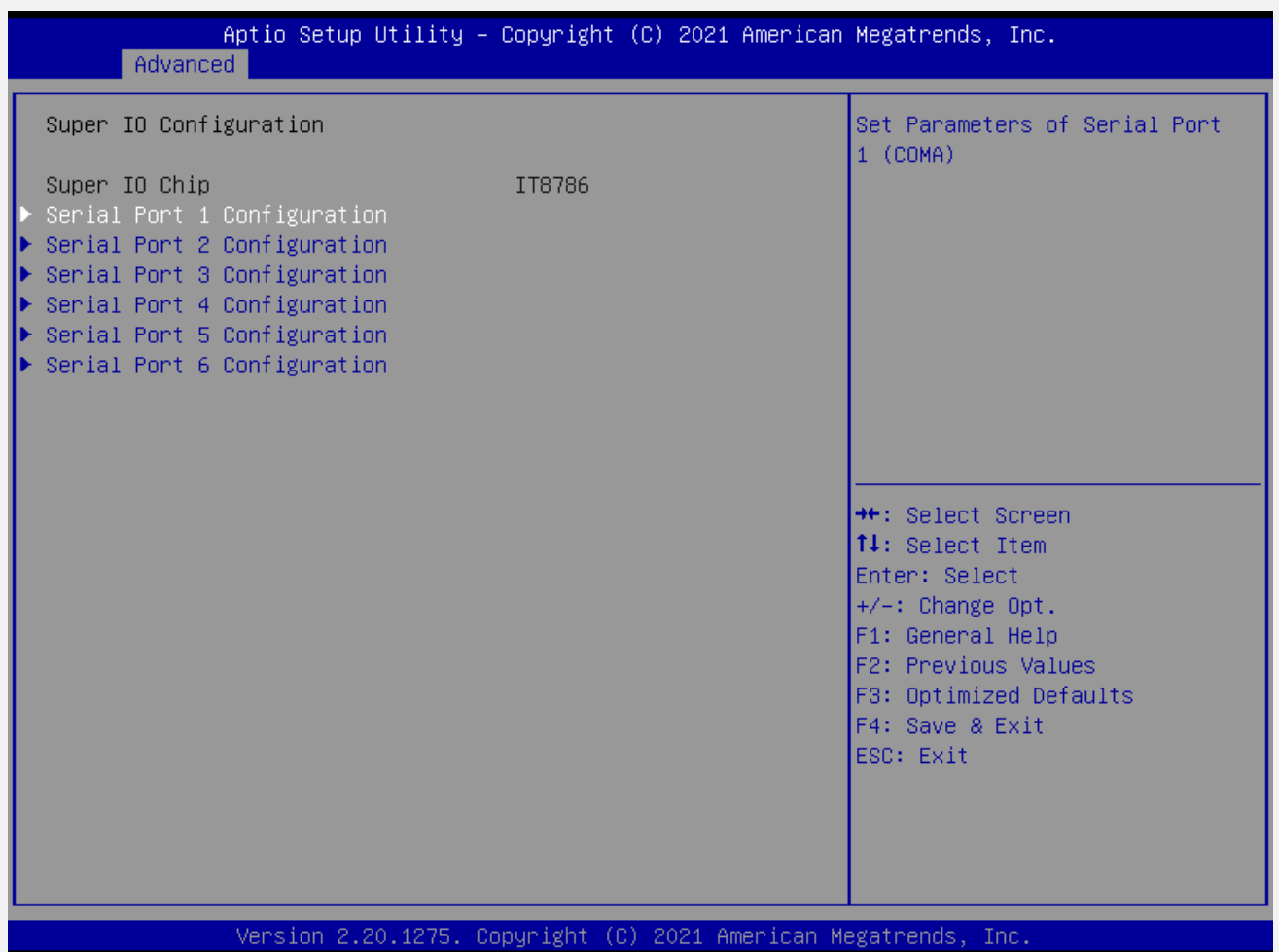

Setup Item	Options	Help Text	Comments
Serial Port 1 Configuration			Set Parameters of Serial Port 1 (COM1)
Serial Port 2 Configuration			Set Parameters of Serial Port 2 (COM2)
Serial Port 3 Configuration			Set Parameters of Serial Port 3 (COM3)
Serial Port 4 Configuration			Set Parameters of Serial Port 4 (COM4)
Serial Port 5 Configuration			Set Parameters of Serial Port 5 (COM5)

Setup Item	Options	Help Text	Comments
Serial Port 6 Configuration			Set Parameters of Serial Port 6 (COM6)

1.2.3.1 Serial PortX Configuration

The Super IO Configuration screen allows the user to view the super IO information, and to enable or disable serial port options. To access this screen from the Advanced screen, choose **Advanced-> Super IO Configuration->Serial PortX Configuration**

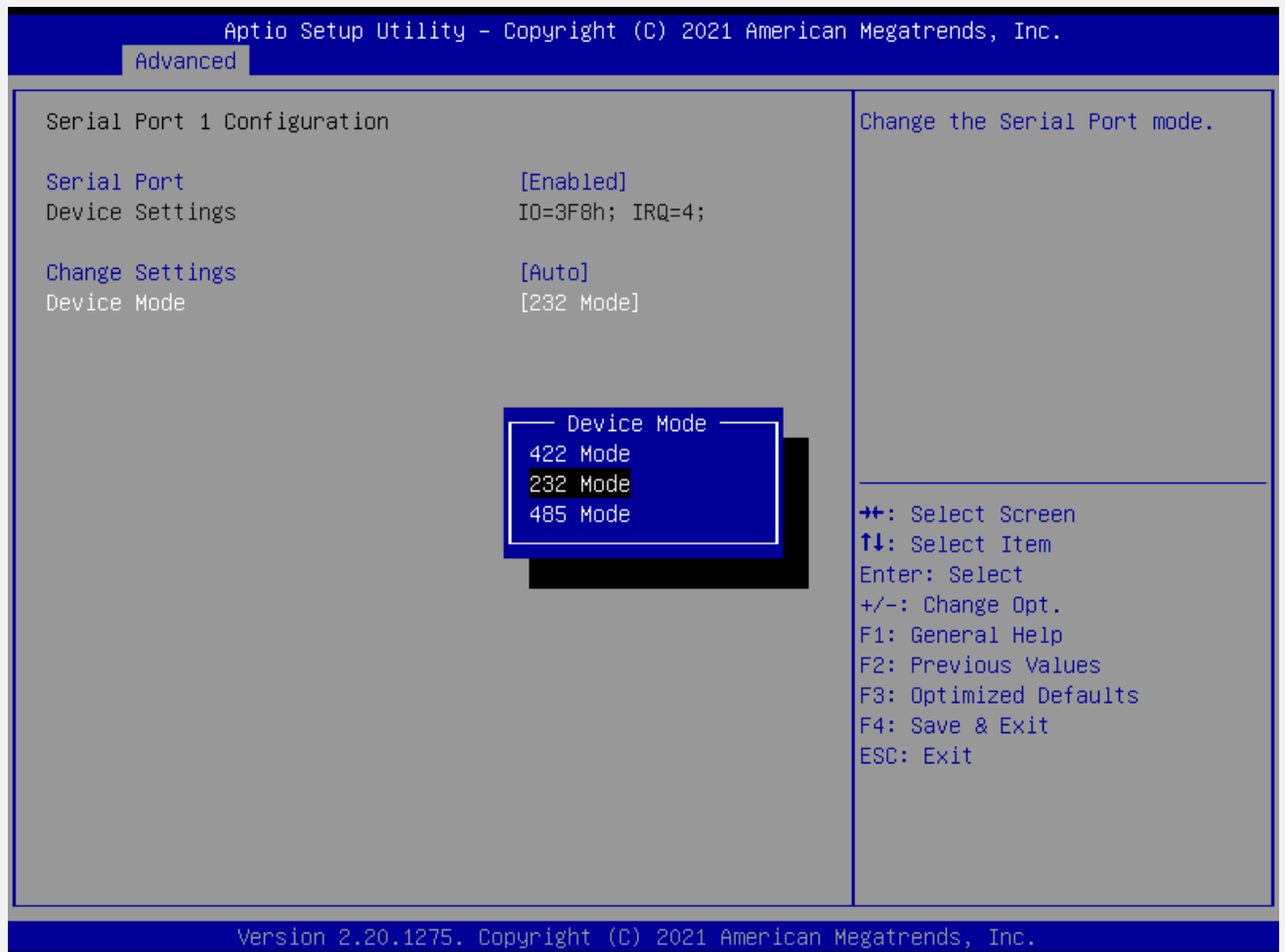

Setup Item	Options	Help Text	Comments
Serial Port	Enabled/Disabled	Enable or Disable Serial Port (COM)	

Setup Item	Options	Help Text	Comments
Change Settings	Auto IO=3F8h; IRQ=4 IO=3F8h; IRQ=3,4,5,6,7,9,10,11,12 IO=2F8h; IRQ=3,4,5,6,7,9,10,11,12 IO=3E8h; IRQ=3,4,5,6,7,9,10,11,12 IO=2E8h; IRQ=3,4,5,6,7,9,10,11,12	Select an optimal settings for Super IO Device	
Device Mode	422 Mode 232 Mode 485 Mode		Com1-2 support 422/232/485,com3-6 support 232 only

1.2.4 Hardware Monitor

The hardware monitor screen allows the user to view the hardware information. To access this screen from the Advanced screen, choose **Advanced-> Hardware Monitor**

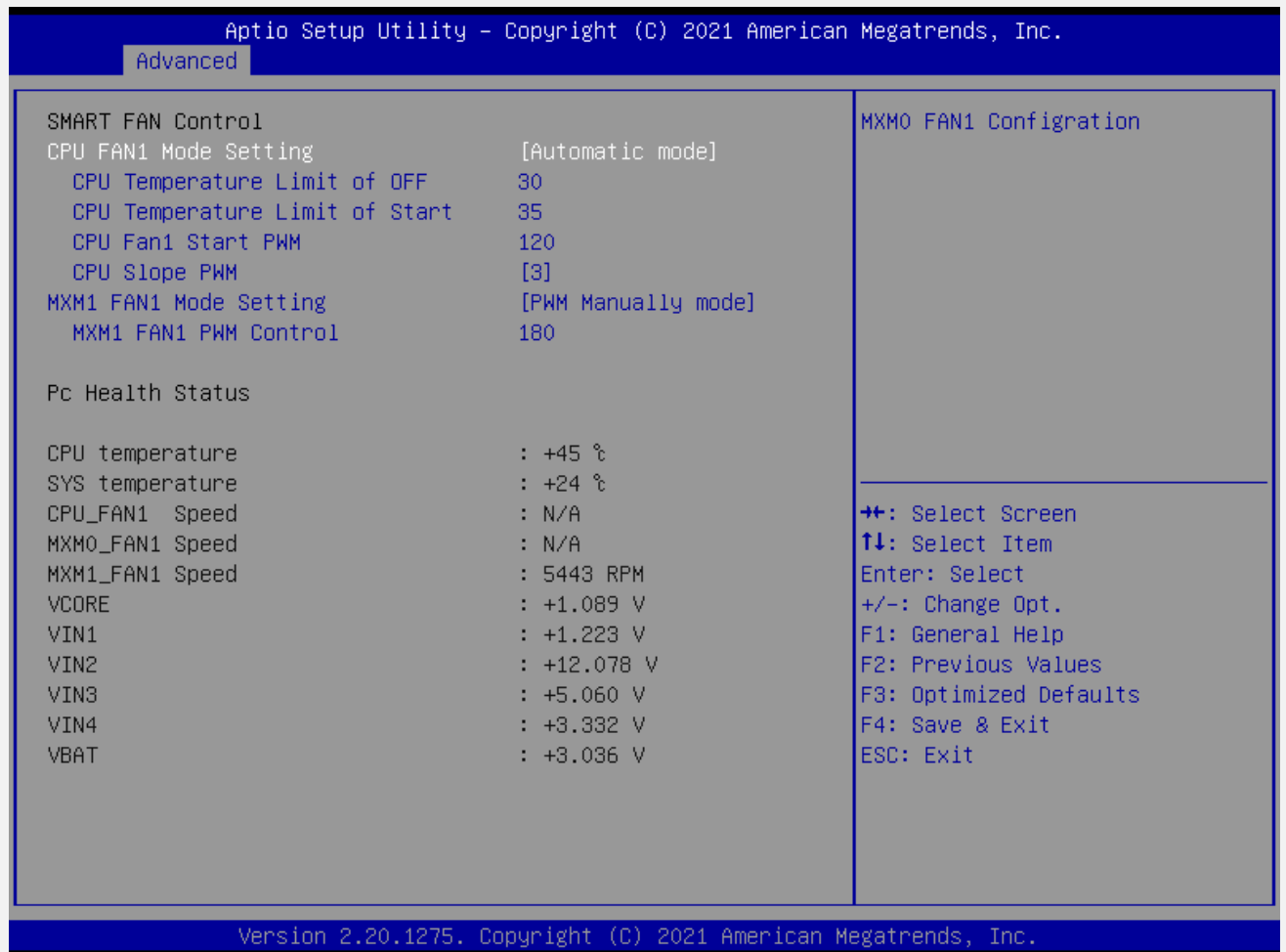

Setup Item	Options	Help Text	Comments
PC Health Status			
CPU Fan Mode Setting	Automatic mode Manual mode	CPU Fan control mode select.	When Manual mode selected, Manual PWM Setting shows to set FAN PWM Duty.
MXM1 Fan Mode Setting	Automatic mode Manual mode	SYS Fan control mode select.	When Manual mode selected, Manual PWM Setting shows to set FAN PWM Duty.
CPU temperature		Shows Current CPU temperature.	NOTE1: Sometimes not the actual temperature value, just indicates temperature tolerance limitation.
CPU Fan Speed			HW Information.
MXM0 Speed			
VCORE			
VIN1			
VIN2			
VIN3			
VIN4			
VBAT			

1.2.5 SATA Configuration

The SATA Configuration screen allows the user to view the SATA Controller information, and to enable or disable SATA Controller options. To access this screen from the Main screen, choose **Advanced > SATA Configuration**.

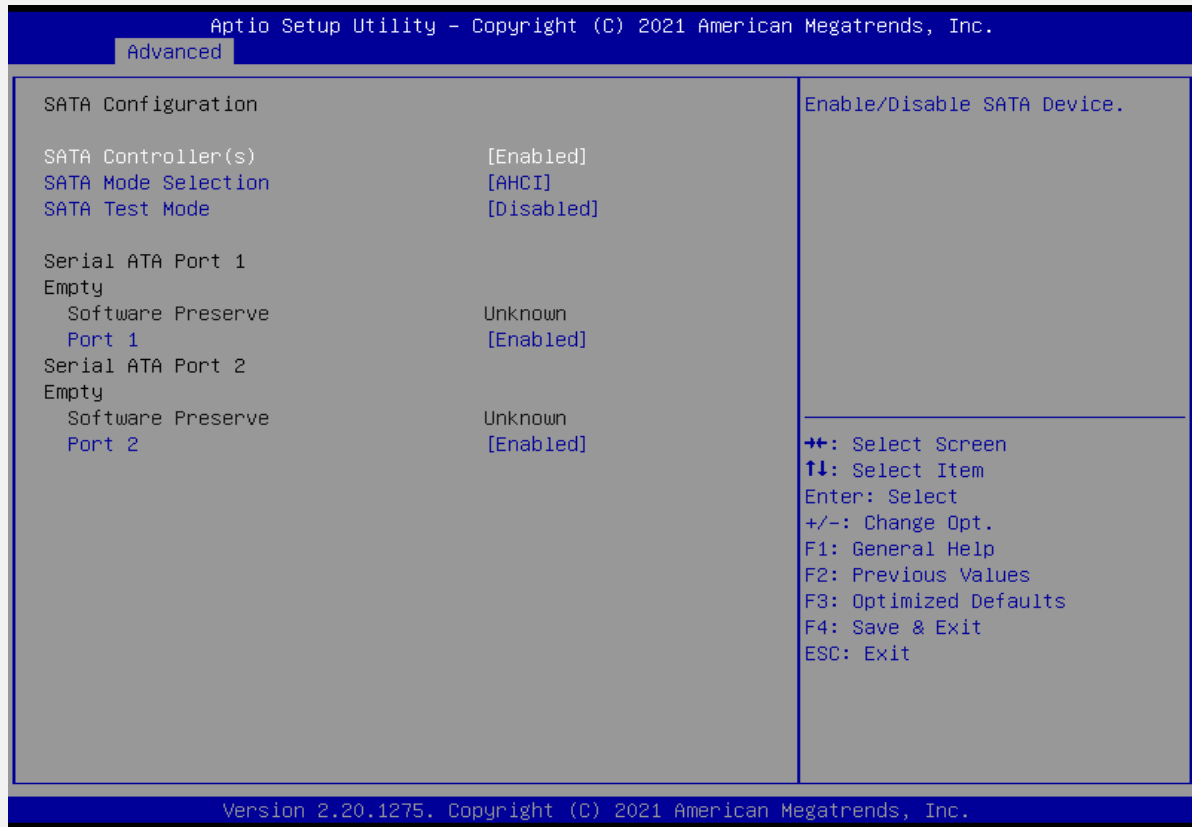

Setup Item	Options	Help Text	Comments
SATA Configuration			
SATA Controller(s)	Enabled Disabled	Enable / Disable SATA Device.	
SATA Mode	AHCI Mode	Select AHCI	
Serial ATA Port 0			Show HDD information connected.
Serial ATA Port 1			

1.2.6 USB Configuration

The USB Configuration screen allows the user to view the USB Configuration information, and to enable or disable options. To access this screen from the Main screen, choose **Advanced > USB Configuration**.

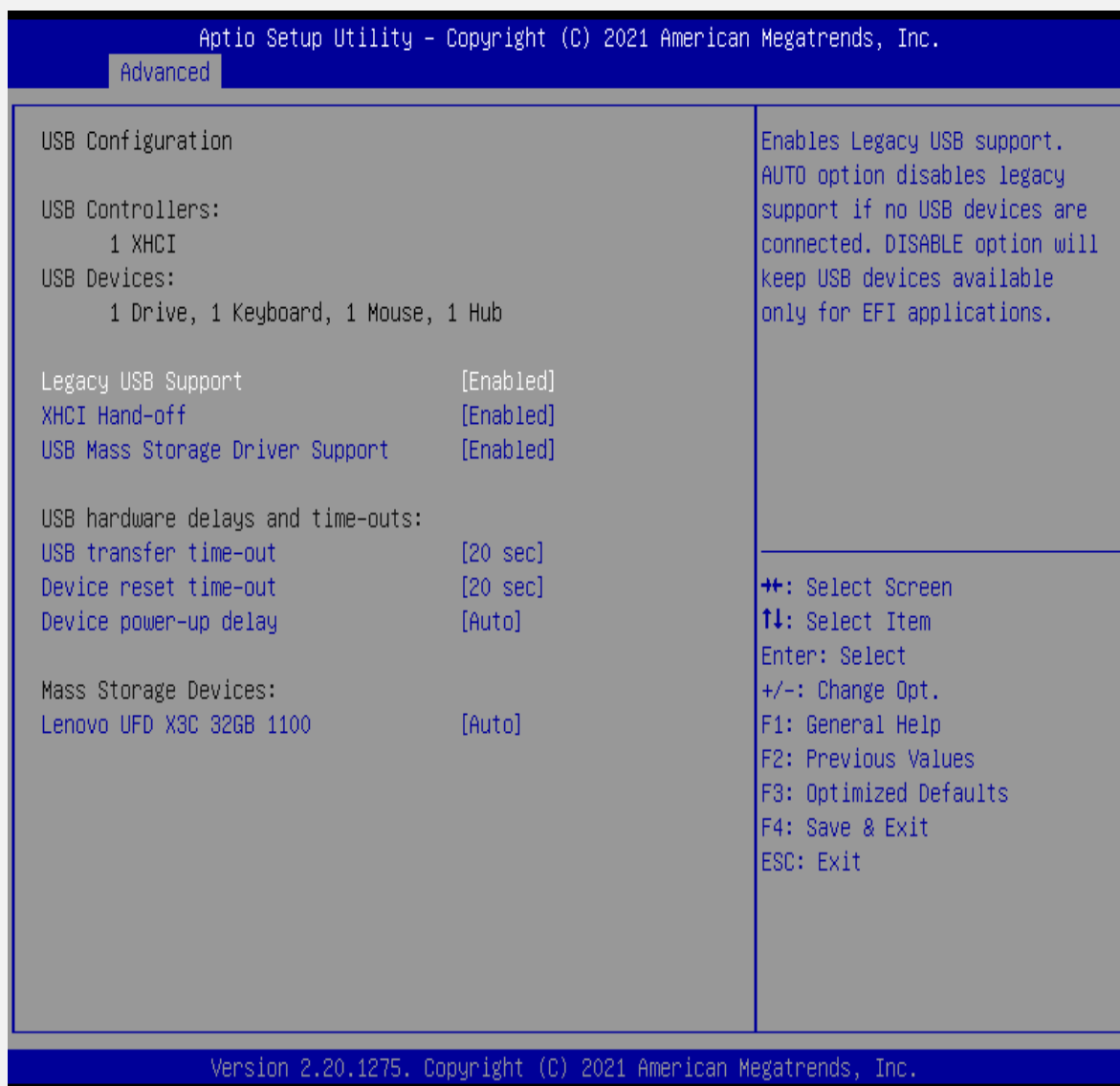

Setup Item	Options	Help Text	Comments
Legacy USB Support	Enabled Disabled	Enables Legacy USB support. AUTO option disables legacy support if no USB devices are connected. DISABLE option will keep USB devices available only for EFI applications.	
XHCI Hand-off	Enabled Disabled	This is a workaround for Oses without XHCI hand-off support. The XHCI ownership change should be claimed by XHCI driver.	

USB MASS Storage Driver	Enabled Disabled	Enable/Disable USB Mass Storage Driver Support.	
USB hardware delays and time-outs:			
USB transfer time-out	1 sec 5 sec 10 sec 20 sec	The time-out value for Control, Bulk, and Interrupt transfers.	
Device reset time-out	1 sec 5 sec 10 sec 20 sec	USB mass storage device Start Unit command time-out.	
Device power-up delay	Auto Manual	Maximum time the device will take before it properly reports itself to the Host Controller. 'auto' uses default value: for a Root port it is 100ms,for a Hub port the delay is taken from Hub descriptor.	

1.2.7 CSM Configuration

The CSM Configuration screen allows the user to view the CSM information, and to enable or disable CSM options. To access this screen from the Main screen, choose **Advanced > CSM Configuration**.

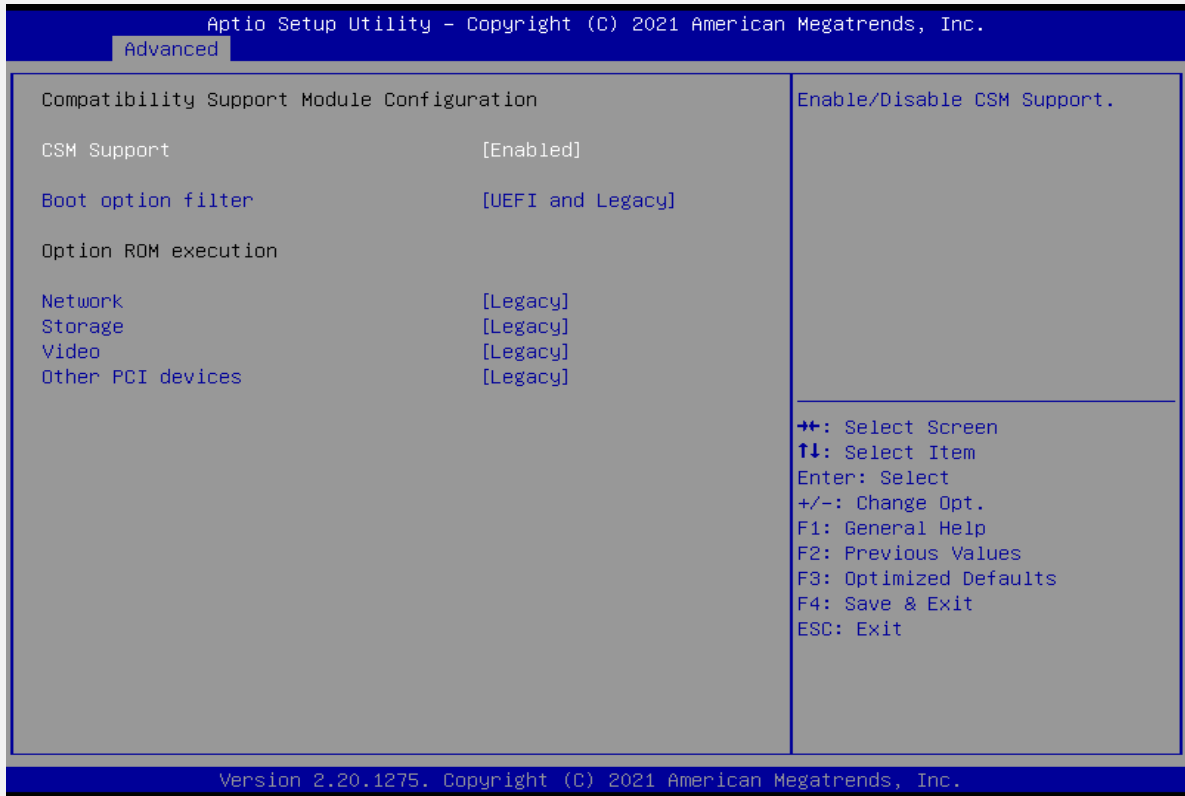

Setup Item	Options	Help Text	Comments
CSM Configuration			
CSM Support	Enabled Disabled	Enable / Disable CSM support	
Boot option filter	UEFI and Legacy Legacy only UEFI only	This option control Legacy/UEFI ROMs priority	
Network	Legacy UEFI Do not lunch	Control the execution of UEFI and Legacy PXE OpROM	
Storage	Legacy UEFI Do not lunch	Control the execution of UEFI and Legacy Storage OpROM	
Video	Legacy UEFI Do not lunch	Control the execution of UEFI and Legacy video OpROM	
Other PCI devices	Legacy UEFI Do not lunch	Determines OpROM execution policy for devices other than Network,Storage or video	

1.2.8 NVMe Configuration

The NVMe Configuration screen allows the user to view the NVMe device information. To access this screen from the Main screen, choose **Advanced > NVMe Configuration**.

Advanced

NVMe Configuration

No NVMe Device Found

←→: Select Screen
↑↓: Select Item
Enter: Select
+/-: Change Opt.
F1: General Help
F2: Previous Values
F3: Optimized Defaults
F4: Save & Exit
ESC: Exit

Setup Item	Options	Help Text	Comments
Controller 0			Show NVMe device information connected.

1.2.9 Watchdog Configuration

The Watchdog Configuration screen allows the user to Set System WatchDog Parameters. To access this screen from the Main screen, choose **Advanced > Watchdog Configuration**.



Setup Item	Options	Help Text	Comments
WatchDog Control	Disabled Enabled		WatchDog function
WatchDog Count Mode	Minute Second		WatchDog Count Mode Selection
WatchDog TimeOut Value	1		Fill WatchDog TimeOut (0~255),0 means function disabled

1.2.10 PXE Boot

The PXE Boot screen allows the user to Enable or Disable Boot Option for Legacy Network Devices. To access this screen from the Main screen, choose **Advanced > PXE Boot**.

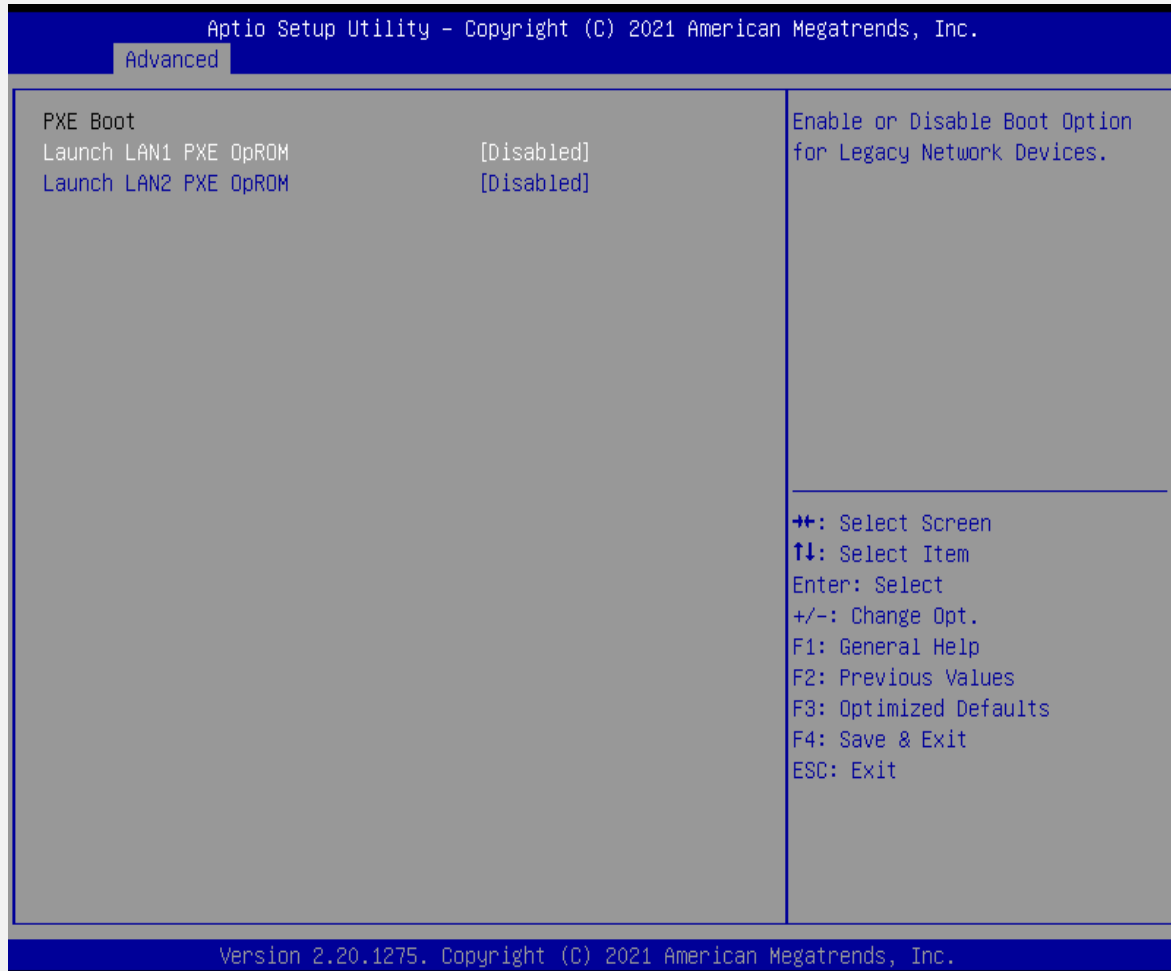

Setup Item	Options	Help Text	Comments
Launch LAN1 PXE OPROM	Disabled Enabled		Legacy PXE Support Control .
Launch LAN1 PXE OPROM	Disabled Enabled		Legacy PXE Support Control .

1.3 Chipset Screen

The Chipset screen provides an access point to configure SA Configuration and PCH-IO configuration. To access this screen from the Main screen, press the right arrow until the **Chipset** screen is chosen.

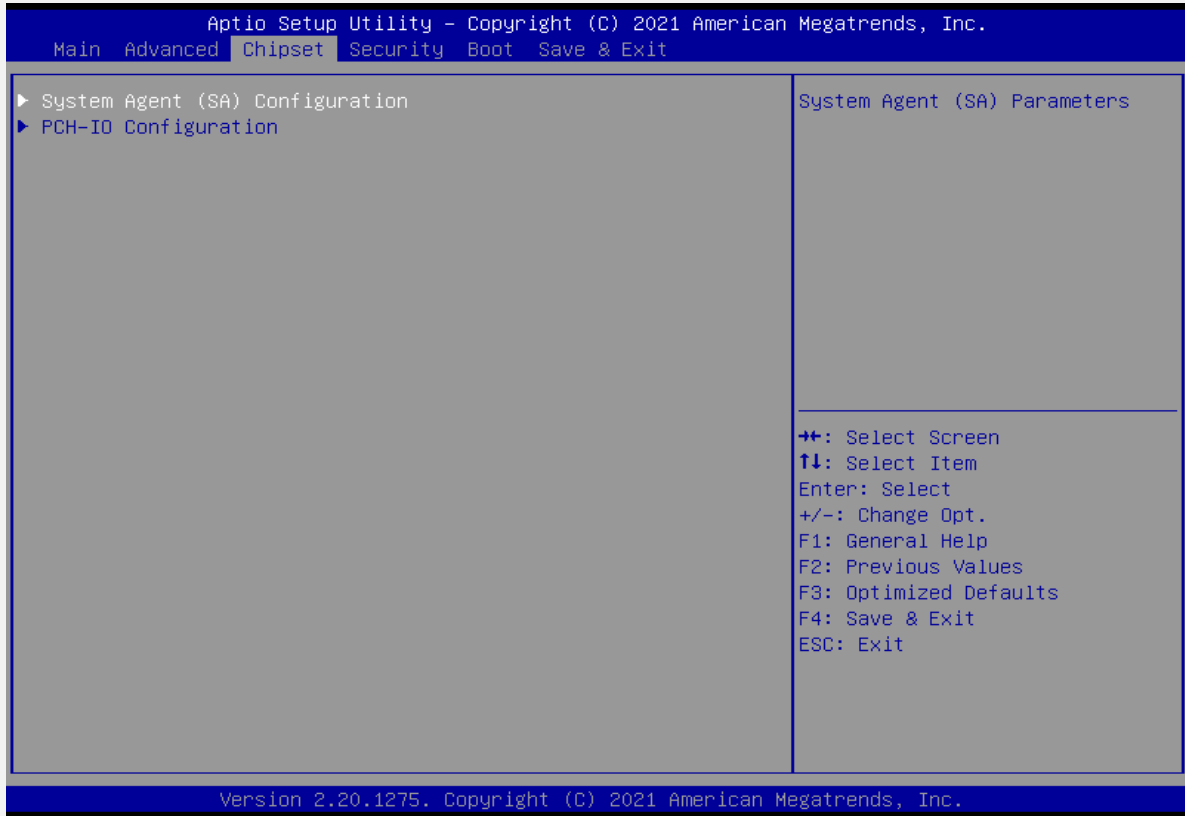

1.3.1 System Agent (SA) Configuration

The North Bridge Screen allows user to set NB chipset configuration.

To access this screen, form the Main screen, choose **Chipset> System Agent (SA) Configuration**

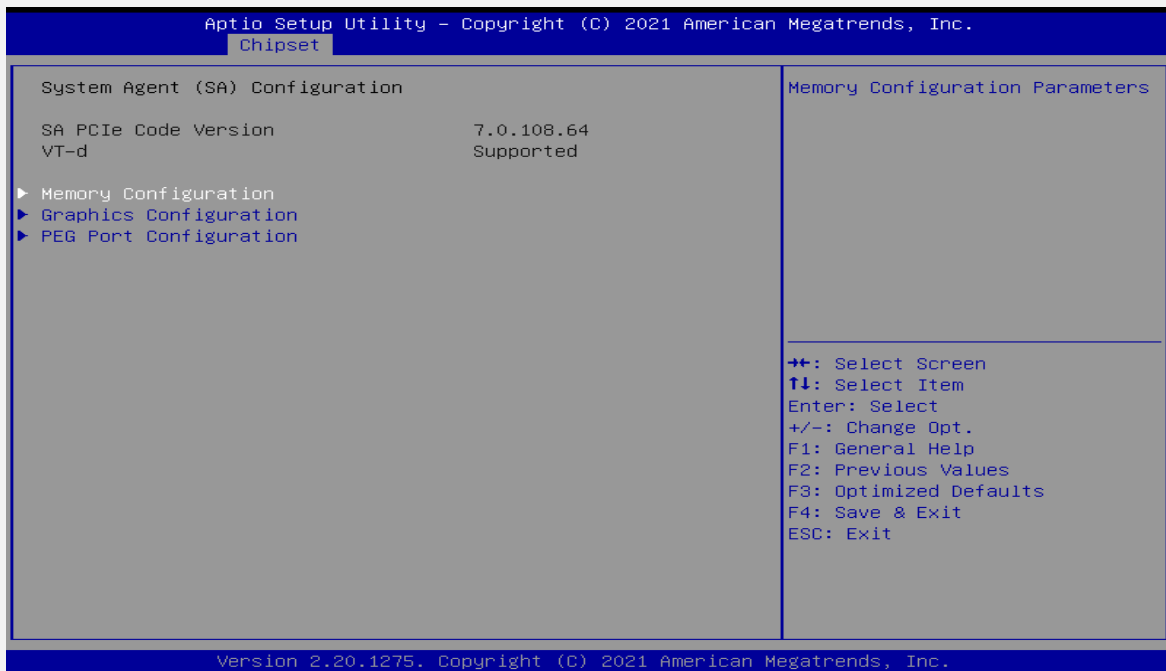

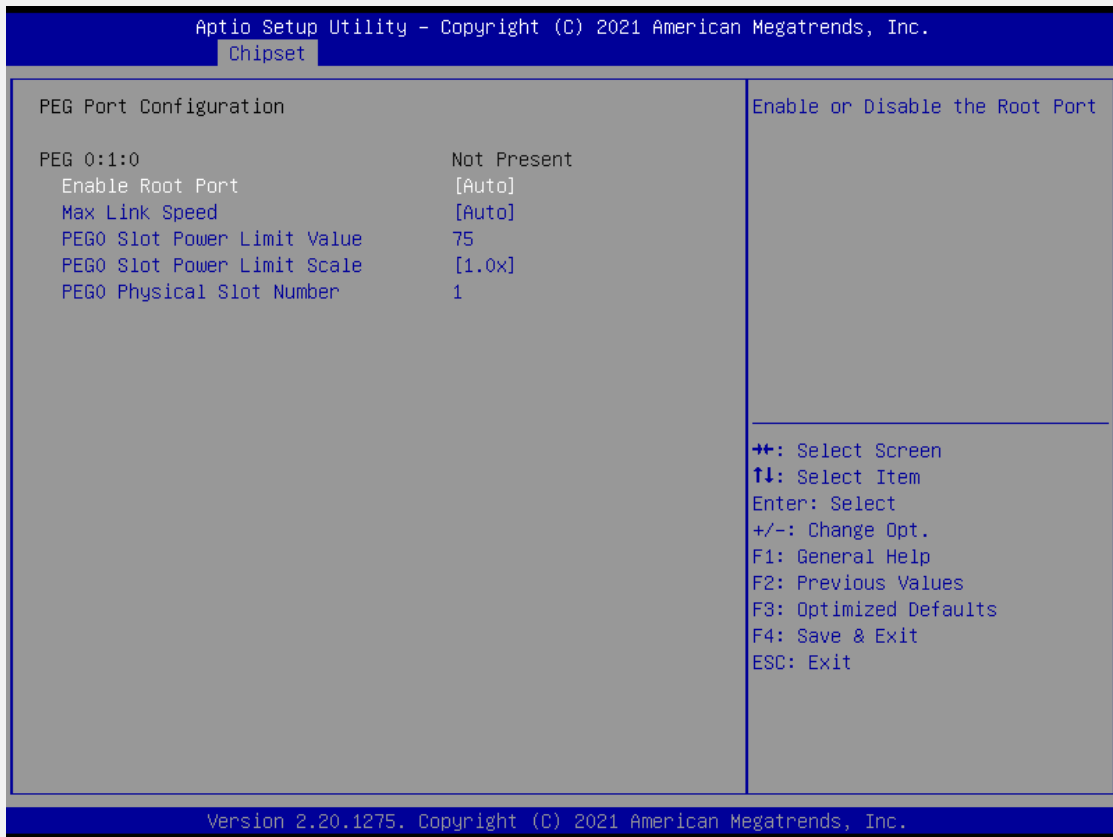
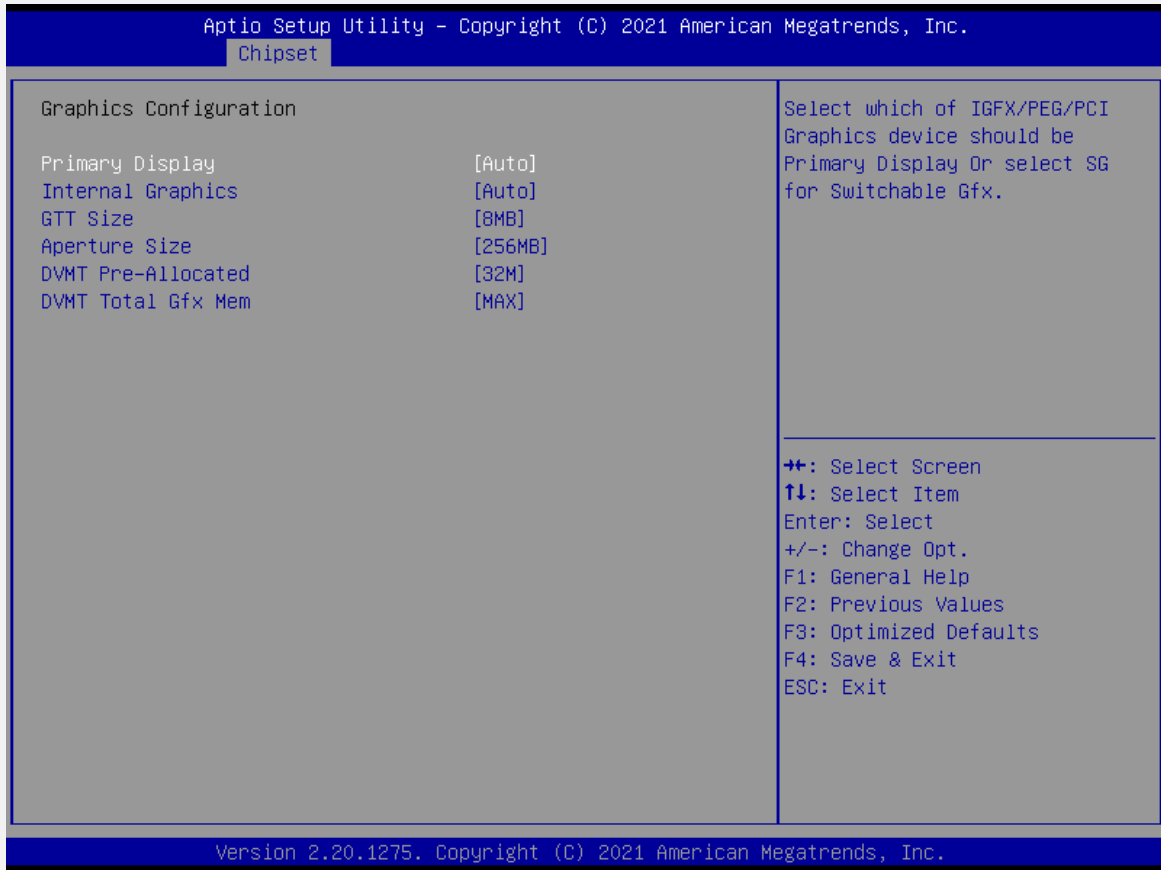

Setup Item	Options	Help Text	Comments
System Agent (SA) Configuration			
Memory Information		Show Memory information	
Internal Graphics	Auto Disabled Enabled	Keep IGFX enabled based on the setup options.	
GTT Size	2MB 4MB 8MB	Select the GTT Size	
Aperture Size	128MB 256MB 512MB 1024MB 2048MB	Select the Aperture Size. Note: Above 4GB MMIO BIOS assignment is automatically enabled when selecting 2048MB aperture. To use this feature, please disable CSM Support.	
DVMT Total Gfx Mem	128M 256M MAX	Select DVMT5.0 Total Graphic Memory size used by the Internal Graphics Device.	
Primary IGFX Boot Display	VBIOS Default EFP LFP	Select the Video Device which will be activated during POST. This has no effect if external graphics present.	

1.3.2 PCH-IO Configuration

The South Bridge Screen allows user to set SB chipset configuration.
To access this screen from the Main screen, choose **Chipset> PCH-IO Configuration**

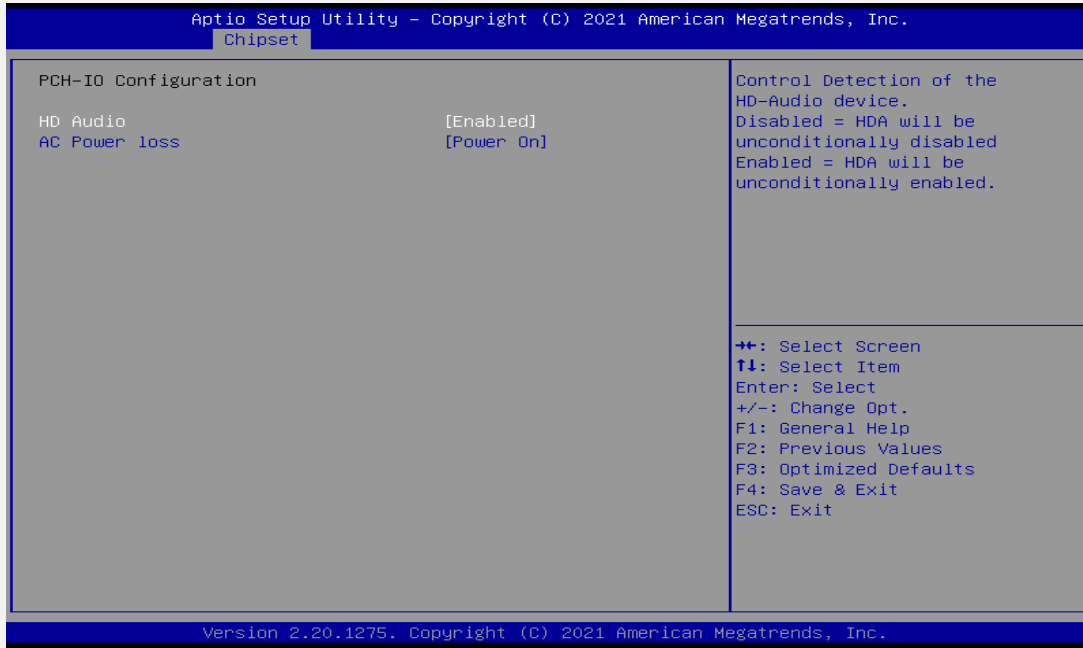

Setup Item	Options	Help Text	Comments
AC Power Loss	Power off Power on	Select AC power state when power is re-applied after a power failure	

1.4 Security

To access this screen form the Main screen, choose **Security**

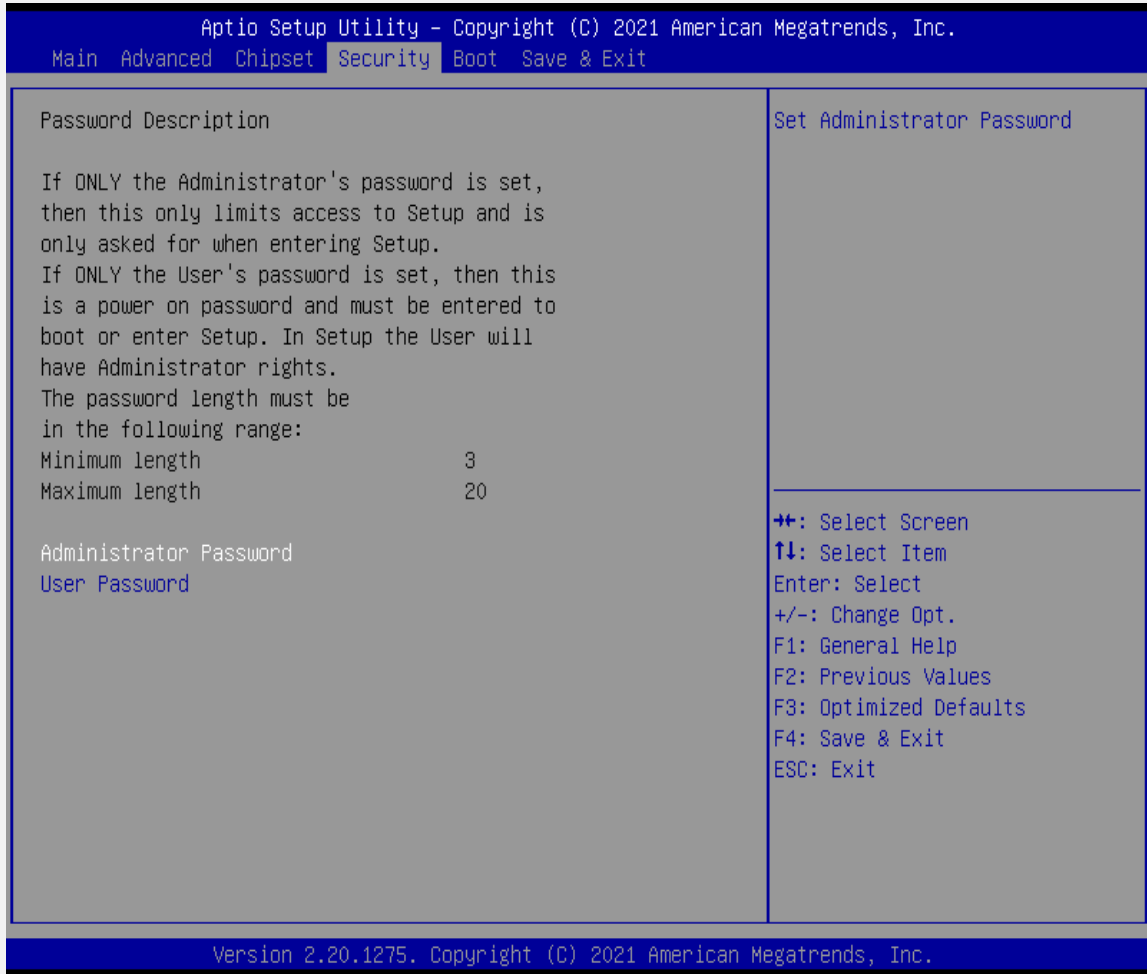

Setup Item	Options	Help Text	Comments
Administrator Password		Set Administrator Password	
User Password		Set User Password	

1.5 Boot Screen

The Boot screen displays any bootable media encountered during POST, and allows the user to configure desired boot device.

To access this screen from the Main screen, choose **Boot**.

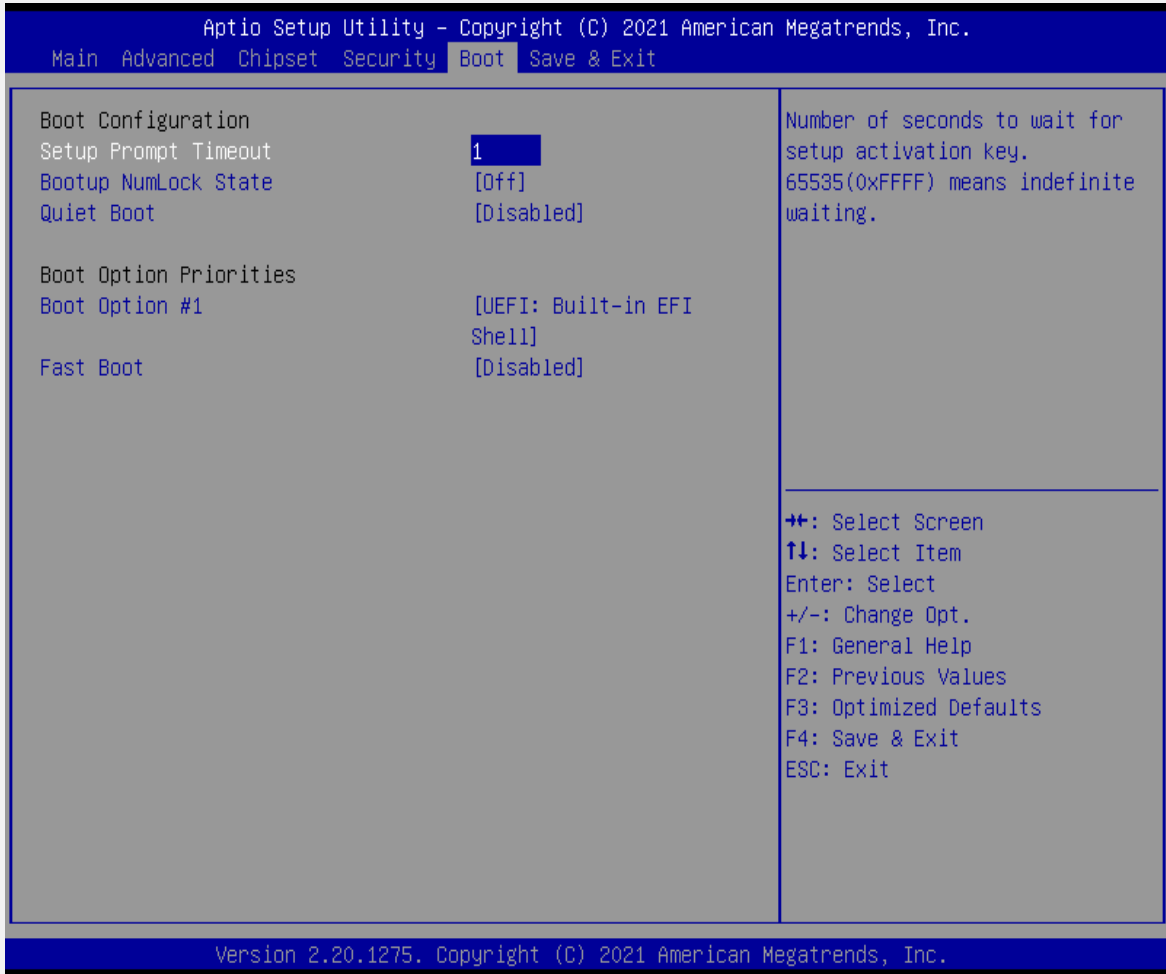

Setup Item	Options	Help Text	Comments
Boot Configuration			
Setup Prompt Timeout	1~65535	Number of seconds to wait for setup activation key.65535(0xFFFF) means indefinite waiting.	
Bootup NumLock State	On off	Select the keyboard Number state.	
Quiet Boot	Disabled Enabled	Enables or disables Quiet Boot option	
Boot Option Priorities			
Boot Option #1		Sets the system boot order	Note: Showed When boot devices existed.
Boot Option #2		Sets the system boot order	
Boot Option #3		Sets the system boot order	

Setup Item	Options	Help Text	Comments
Hard Drive BBS Priorities		Set the order of the legacy devices in this group	Set boot order in each group of the same kind, such as HDD, network.

1.6 Save & Exit Screen

The Save & Exit screen allows the user to choose whether to save or discard the configuration changes made on the other screens. It also allows the user to restore the server to the factory defaults or to save or restore them to set of user-defined default values.

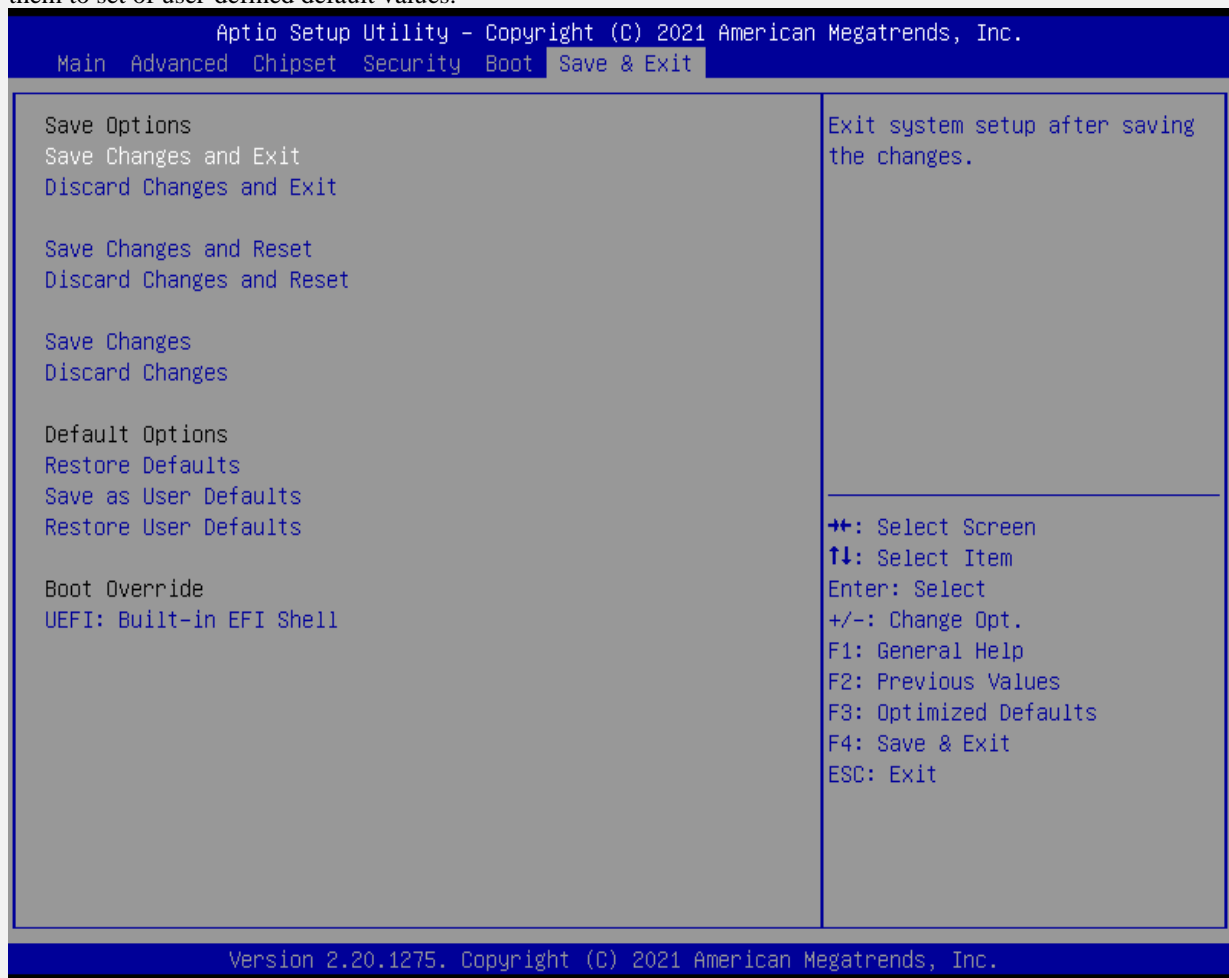

Setup Item	Options	Help Text	Comments
Save Changes and Exit		Exit system setup after saving the changes.	User is prompted for confirmation only if any of the setup fields were modified.
Discard Changes and Exit		Exit system setup without saving any changes.	

Setup Item	Options	Help Text	Comments
Save Changes and Reset		Reset the system after saving the changes..	
Discard Changes and Reset		Reset system setup without saving and changes.	
Save Changes		Save Changes done so far to any of the setup options.	
Discard Changes		Discard Changes done so far to any or the setup options.	
Default Options			
Restore Defaults		Restore/Load Default values for all the setup options.	
Save as User Defaults		Save the changes done so far as User Defaults.	
Restore User Defaults		Restore the User Defaults to all the setup options.	
Boot Override			
Shows the Device can boot.			Note: Shown When boot devices existed.

第四章 产品结构图

1. 产品尺寸图

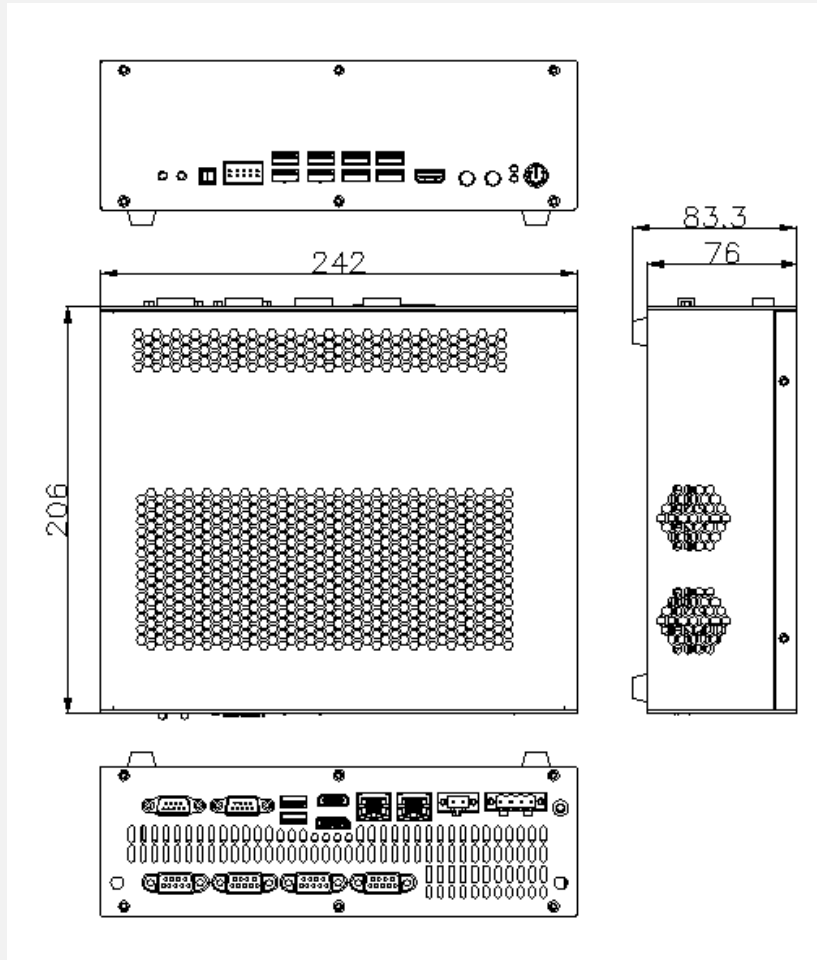

2. 装配示意图一

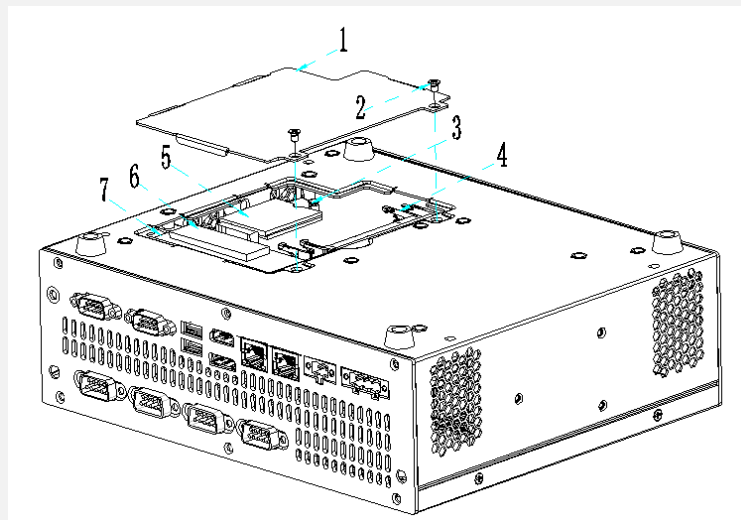

1) 名称：1. 内存盖 2. 螺丝 3. 5G 模块 4. 内存 5. 4G 模块 6. 导热垫（硬盘散热） 7. M.2 硬盘

2) 装配步骤：

(1) 拆开内存盖 2 颗螺丝

(2) 可装配：内存 M.2 硬盘 4G 模块 5G 模块 4G 卡

3. 装配示意图二

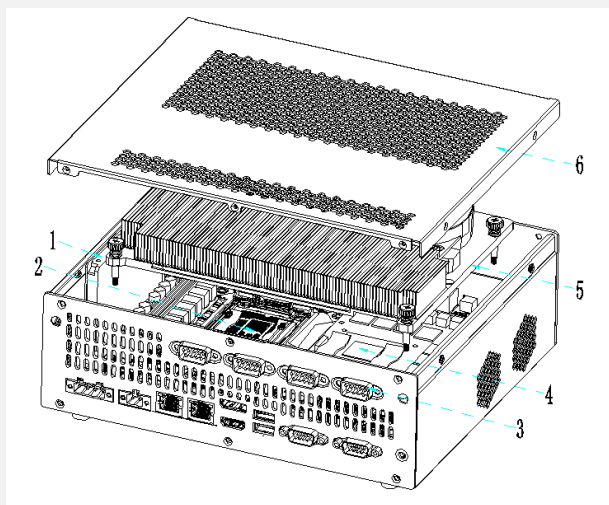

1) 名称：1. 硬盘(2.5 寸厚度 7mm) 2 .CPU 3. 外扩 4 个 COM 4. GPU-MXM 显卡 5. 散热器模组 6. 箱盖

2) 装配步骤：

(1) 拆开箱盖 10 颗螺丝

(2) 扭松散热器模组 4 颗螺丝，有二种散热器模组，第一种是铝齿片，第二种是铜齿片

(3) 装配 CPU 和 GPU，硬盘

附录

术语表

ACPI

高级配置和电源管理。ACPI 规范允许操作系统控制计算机及其附加设备的大部份电能。

BIOS

基本输入/输出系统。是在 PC 中包含所有的输入/输出控制代码界面的软件。它在系统启动时进行硬件检测，开始操作系统的运作，在操作系统和硬件之间提供一个界面。BIOS 是存储在一个只读存储器芯片内。

BUS

总线。在计算机系统中，不同部件之间交换数据的通道，是一组硬件线路。我们所指的 BUS 通常是 CPU 和主内存元件内部的局部线路。

Chipset

芯片组。是为执行一个或多个相关功能而设计的集成芯片。我们指的是由南桥和北桥组成的系统级芯片组，他决定了主板的架构和主要功能。

CMOS

互补金属-氧化物半导体。是一种被广泛应用的半导体类型。它具有高速、低功耗的特点。我们指的 CMOS 是在主板上的 CMOS RAM 中预留的一部份空间，用来保存日期、时间、系统信息和系统参数设定信息等。

COM

串口。一种通用的串行通信接口，一般采用标准 DB9 公头接口连接方式。

DIMM

双列直插式内存模块。是一个带有内存芯片组的小电路板。提供 64bit 的内存总线宽度。

DRAM

动态随机存取存储器。是一个普通计算机的通用内存类型。通常用一个晶体管和一个电容来存储一个位。随着技术的发展，DRAM 的类型和规格已经在计算机应用中变得越来越多样化。例如现在常用的就有 SDRAM、DDR SDRAM 和 RDRAM。

I2c

Inter-Integrated Circuit 总线是一种由 PHILIPS 公司开发的两线式串行总线，用于连接微控制器及其外围设备。

LAN

局域网络接口。一个小区域内相互关联的计算机组成的一个计算机网络，一般是在一个企事业单位或一栋建筑物。局域网一般由服务器、工作站、一些通信链接组成，一个终端可以通过电线访问数据和设备的任何地方，许多用户可以共享昂贵的设备和资源。

LED

发光二极管，一种半导体设备，当电流流过时它会被点亮，通常用来把信息非常直观地表示出来，例如表示电源已经导通或硬盘驱动器正在工作等。

PnP

即插即用。允许 PC 对外接设备进行自动配置，不用用户手动操作系统就可以自己工作的一种规格。为实现这个特点，BIOS 支持 PnP 和一个 PnP 扩展卡都是必需的。

POST

上电自检。在启动系统期间，BIOS 会对系统执行一个连续的检测操作，包括检测 RAM，键盘，硬盘驱动器等，看它们是否正确连接和是否正常工作。

PS/2

由 IBM 发展的一种键盘和鼠标连接的接口规范。PS/2 是一个仅有 6PIN 的 DIN 接口，也可以用以连接其他的设备，比如调制解调器。

USB

通用串行总线。一种适合低速外围设备的硬件接口，一般用来连接键盘、鼠标等。一台 PC 最

多可以连接 127 个 USB 设备，提供一个 12Mbit/s 的传输带宽；USB 支持热插拔和多数数据流功能即在系统工作时可以插入 USB 设备，系统可以自动识别并让插入的设备正常。