

EMA-B75A

mATX 工控板

USER' Manual V1.0

USER'S MANUAL 用户手册

声明

本使用说明书内容如有变更，恕不另行通知。本公司并不对本使用说明书之适用性，适合做某种特殊用途之使用或其他任何事项做任何明示，或做其他形式之保证或担保。因此本公司将不对手册内容之错误，或因增减展示或以其他方式使用本手册所造成之直接，间接，突发性过、或继发性之损害负任何责任。

版权声明：

版权所有-----深圳智锐通科技有限公司。未经本公司许可或依著作权法之规定许准，不得复制，节录和翻译使用说明书之任何内容。

安全须知

1	产品使用前，务必仔细阅读产品说明书。
2	对未准备安装的板卡，应将其保存在防静电保护袋中。
3	在从包装袋中拿板卡前，应将手先置于接地金属物体上一会儿，以释放身体及手中的静电。
4	在拿板卡时，需佩带静电保护手套，并且应该养成只触及边缘部份的习惯。
5	主板与电源连接时，请确认电源电压。
6	为避免人本被电击或产品被损坏，在每次对主板、板卡进行拔插或生新配置时须先关闭交流电源或将交流电源线从电源插座中拔掉。
7	在对板卡进行搬动前，先将交流电源线从电源插座中拔掉。
8	当您需连接或拔除任何设备前，须确定所有的电源线事先已被拔掉。
9	为避免频繁开关机对产品造成不必要的损伤,关机后,应至少等待30秒后再开机。
10	设备在使用过程时出现异常情况，请找专业人员处理。

目录

第一章 产品介绍.....	6
1.1 产品规格.....	6
1.2 功能框图.....	8
1.3 产品配件.....	8
1.4 产品料号.....	9
1.5 产品照片.....	9
第二章 安装说明.....	10
2.1 接口/尺寸图.....	10
2.2 硬件安装.....	11
2.3 跳线功能设置.....	11
2.3.1 清 CMOS 跳线设置.....	11
2.3.2 串口 COM1, RS233/ RS485/ RS422 模式跳冒选择	11
2.3.3 COM1/2 电压模式选择	12
2.3.4 AT/ ATX 选择.....	12
2.3.5 USB 插针定义.....	12
2.3.6 COM 插针定义.....	13
2.3.7 GPIO 插针定义.....	13
2.3.8 LPC_BUS debug 接口.....	14
2.3.9 FPANEL 前面板状态接口.....	14
2.3.10 AUDIO 插针.....	14
2.3.11 LPT 插针接口.....	15
2.3.12 SPEAK 插针接口.....	15

2.3.13 FAN 插针接口	15
2.3.14 AT 插针接口	15
2.4 插针定义	16
第三章 BIOS 程序设置	18
3.1 Main Screen	19
3.2 Advanced Screen	21
3.2.1 ACPI Settings Screen	22
3.2.2 CPU Configuration Screen	23
3.2.3 SATA Configuration Screen	25
3.2.4 USB Configuration Screen	27
3.2.5 Super IO Configuration Screen	29
3.2.5.1 Serial Port X Configuration Screen	30
3.2.6 Hardware Monitor	31
3.2.7 Watchdog configuration	33
3.2.8 CPU PPM configuration	34
3.3 Chipset Screen	35
3.3.1 System Agent (SA) Configuration	36
3.3.2 South Bridge Screen	38
3.4 Boot Screen	39
3.5 Security Screen	40
3.6 Save & Exit Scree	41
附录	42
附一： Watchdog 编程指引	42
附二： 术语表	43

第一章 产品介绍

1.1 产品规格

Model		EMA-B75A
配置 Item	规格 Specification	描述 Describe
处理器 Processor System	CPU	Intel 2/3 th Sandy/Ivy Bridge LGA1155
	芯片组 Chipset	Intel PCH B75
	BIOS	AMI 64MBit SPI
内存 Memory	规格 Technology	DDR3 1333/1600MHz
	最大容量 Max. Capacity	16GB
	插槽 Socket	2 x U-DIMM
扩展插槽 Expansion Slot	PCI-Express	1 x PCI-Express 16x 1 x PCI-Express 4x
	PCI	2 x PCI
存储 Storage	SATA	1 x SATA3.0 3 x SATA2.0
	mSATA	1 x mSATA
显示 Graphics	最多显示 Multiple Display	2 Ports
	I/O	1 x VGA 1 x DVI-D
	分辨率 Resolution	VGA:2048*1536@60Hz DVI:1920*1080@60Hz
USB / Type-C	I/O	2 x USB3.0 4 x USB2.0
	插针 Header Pin	1 x USB3.0 (1 x 2.0mm_2*10Pin) 2 x USB2.0 (2 x 2.54mm_2*5Pin)
以太网 Ethernet	控制器 Controller	Intel® Ethernet Controller I211-AT
	I/O	2 x RJ45 10/100/1000M

串口 COM	I/O	4 x RS232(4 x 2.54mm_2*5Pin)
	插针 Header Pin	4 x RS232
GPIO	插针 Header Pin	1 x 8bit GPIO (1 x 2.54mm_2*5Pin)
音频 Audio	芯片 Chipset	Integrated High Definition Audio Stereo (ALC662)
	I/O	1 x Line In 1 x Line Out 1 x MIC In
	插针 Header Pin	1 x Line In 1 x Line Out 1 x MIC In
PS2	I/O	1 x PS2
其它 Others	按钮 Button	1 x Power Button 1 x RV Button 1 x Clear CMOS 1 x Reset Button
	LPC	1 x LPC
	LPT	1 x LPT
电源 Power Requirements	电源类型 Power Type	ATX
环境 Environment	工作温度 Operating Temperature	0~60°C
	存储温度 Storage Temperature	-40~85°C
	工作湿度 Operating Humidity	0~95%
物理特性 Physical	尺寸 Dimensions	mATX (243.8*243.8*1.6 mm)
	PCB 颜色 Color	Green

1.2 功能框图

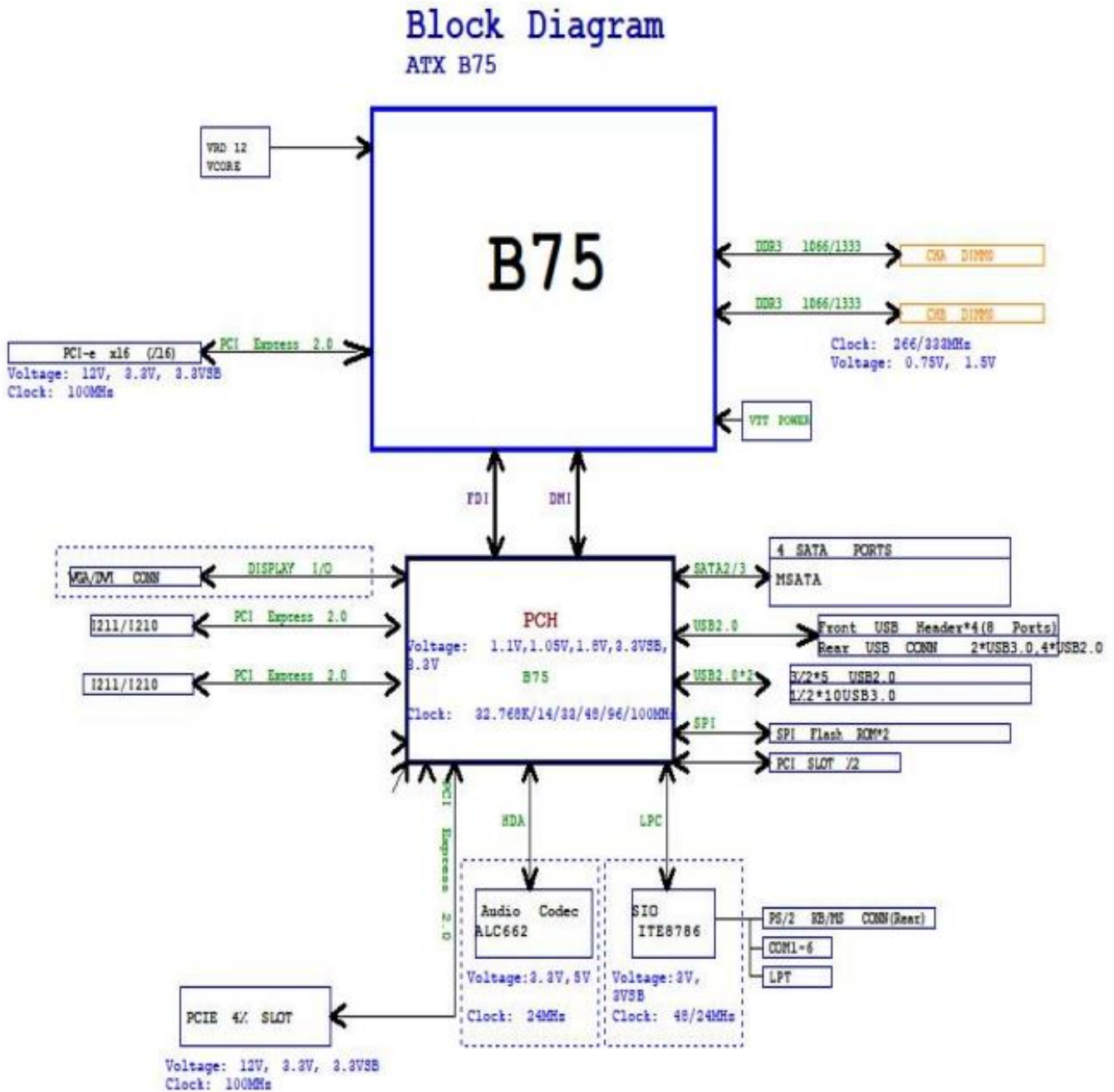

1.3 产品配件

Model Name	Part Number	Specification
SATA 线	1.ZRT.46-6142-00-A00	SATA-7P 直头带弹片转 SATA-7P 直头带弹片 /L=450MM/用 PE 袋包装好
COM 线	1.ZRT.46-6143-00-A00	COM 线+2×5pin 杜邦线,2.54,*DB9 公头,带螺柱,L=350MM,黑色,龙威信,WI-GC-XX-12244
IO 挡板	1.ZRT.30-6232-00-A00	B75-ATX-M01 SUS430 T=0.2mm 表面加字符

1.4 产品料号

Model Name	Part Number	Specification
EMA-B75A	8.ZRT.80-8308-00-LFF	主板-ZRT-EMA-B75A、mATX(244*244mm)、B75A、2*LAN/6*COM/2*PCIE/2*PCI-工包 10 入
	8.ZRT.80-8308-01-LFF	主板-ZRT-EMA-B75A、mATX(244*244mm)、B75A、2*LAN/6*COM/2*PCIE/2*PCI、不带音频-工包 10 入

1.5 产品照片

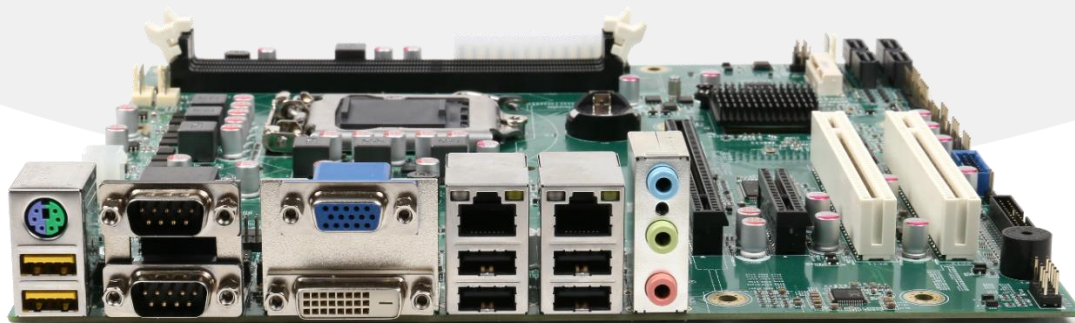
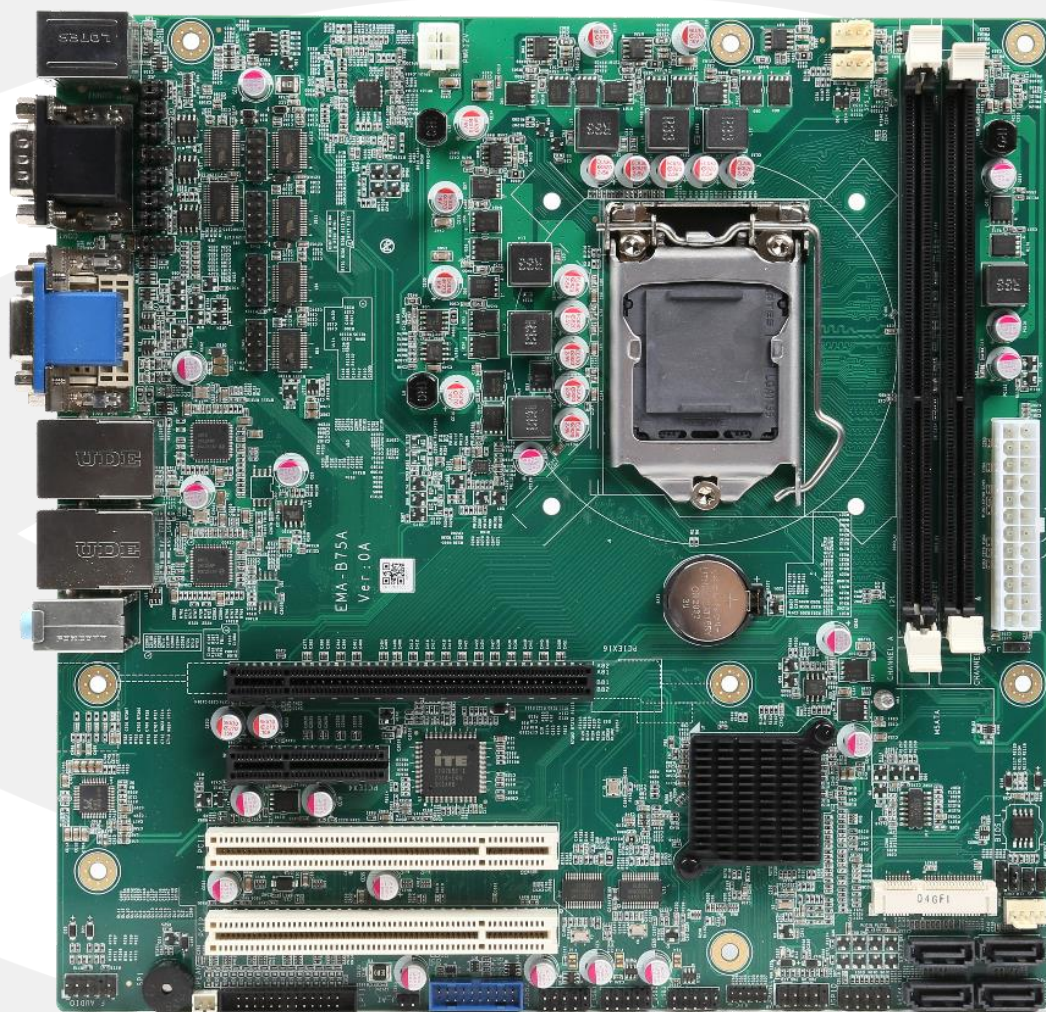

第二章 安装说明

2.1 接口/尺寸图

安装设备时, 请对照此示意图并详细阅读下面的说明, 安装组件过程中必须小心, 对于有些部件, 如果安装不正确, 设备将不能正常工作。

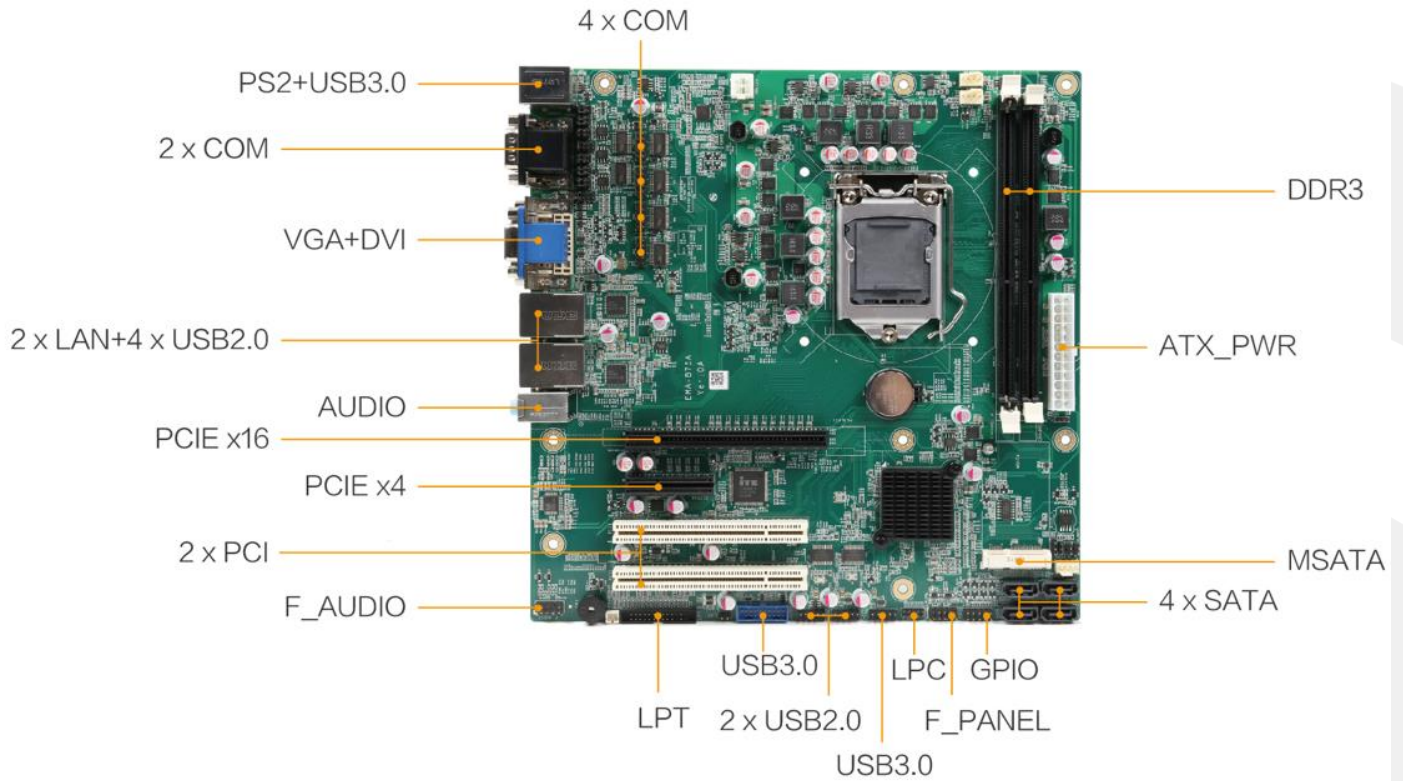

接口位置图

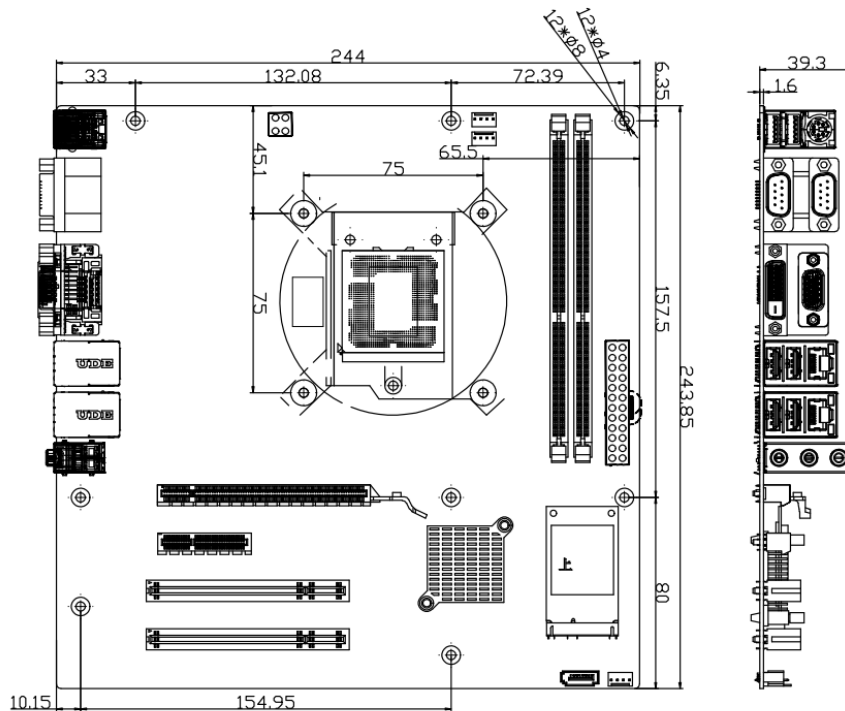

Mechanical Drawing (TOP Side)

2.2 硬件安装

⚠ 注意：操作时，请戴上防静电手套，因为静电有可能会损坏部件。

本主板关键元器件都是集成电路，而这些元件很容易因为遭受静电的影响而损坏。因此，请在正式安装主板之前，请先做好以下的准备：

1. 拿主板时手握板边，尽可能不触及元器件和插头插座的引脚。
2. 接触集成路元件（如 CPU、RAM 等）时，最好戴上防静电手环/手套。
3. 在集成电路元件未安装前，需将元件放在防静电垫或防静电袋内。
4. 在确认电源的开关处于断开位置后，再插上电源插头。

2.3 跳线功能设置

在进行硬件设备安装之前，请按照您的需要对相应的跳线进行设置。

提示：如何识别跳线、接口的第 1 针脚，观察插头插座旁边的文字标记，会用“1”或加粗的线条或三角符号表示；看看背面的焊盘，方型焊盘为第 1 针脚；所有跳线的针脚 1 旁都有 1 个白色箭头。

2.3.1 清 CMOS 跳线设置

主板提供插针 CLR_CMOS 来清 CMOS，CLR_CMOS 插针定义如下：



设置	功能
1-2 短路	清除 CMOS 内容，所有 BIOS 设置恢复成出厂值
2-3 短路	正常工作状态(Default)

2.3.2 串口 COM1, RS232/ RS485/ RS422 模式跳冒选择

DB9 串口 RS232 定义

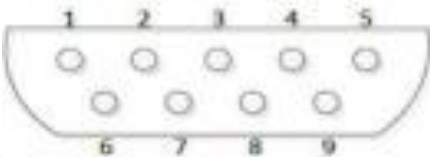

1: DCD	6: DSR
2: RX	7: RTS
3: TX	8: CTS
4: DTR	9: RI
5: GND	

DB9 串口 RS485 定义

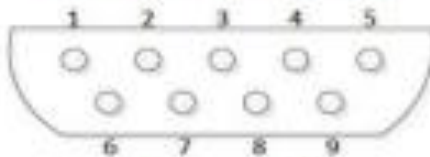

1: RS485-	6: NC
2: RS485+	7: NC
3: NC	8: NC
4: NC	9: NC
5: GND	

DB9 串口 RS422 定义

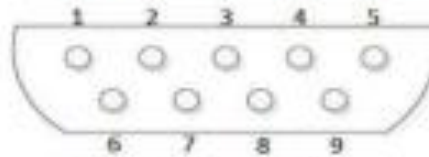

1: RS422_TX-	6: NC
2: RS422_TX+	7: NC
3: RS422_RX+	8: NC
4: RS422_RX-	9: NC
5: GND	

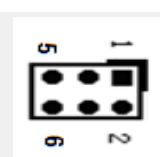

JC1/JC2/JC5/JC6

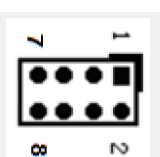

JC3/JC7

COM1 串口模式选择:

COM1	RS232 模式	RS485 模式	RS422 模式
JC1	1-3,2-4	3-5,4-6	3-5,4-6
JC2	1-3,2-4	3-5,4-6	3-5,4-6
JC3	1-2	5-6,7-8	3-4,7-8

COM2 串口模式选择:

COM2	RS232 模式	RS485 模式	RS422 模式
JC5	1-3,2-4	3-5,4-6	3-5,4-6
JC6	1-3,2-4	3-5,4-6	3-5,4-6
JC7	1-2	5-6,7-8	3-4,7-8

2.3.3 COM1/2 电压模式选择

COM1 电压模式选择:

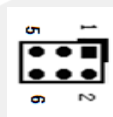

COM1	SUPPORT RING IN	SUPPORT +12V OUT	SUPPORT +5V OUT
JC4	1-2	3-5,2-4	3-5, 4-6

COM2 电压模式选择:

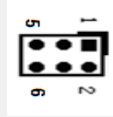

COM1	SUPPORT RING IN	SUPPORT +12V OUT	SUPPORT +5V OUT
JC8	1-2	3-5,2-4	3-5, 4-6

2.3.4 AT/ ATX 选择

default 不上跳帽



设置	功能
1-2 打开	ATX Mode
2-3 打开	AT Mode

2.3.5 USB 插针定义

USB 2.0 插针接口, 2.54mm_2x5pin_ 第 9pin 空, 位置: F_USB1,F_USB2

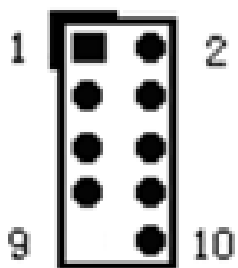

管脚	信号名称	管脚	信号名称
1	5V	2	5V
3	USB1_Data-	4	USB2_Data-
5	USB1_Data+	6	USB2_Data+
7	GND	8	GND
9	--	10	GND

USB 3.0 插针接口, 2.0mm_2x10pin_ 蓝色带框_第 20pin 空, 位置: JUSB2

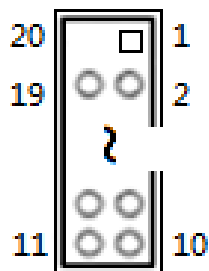

管脚	信号名称	管脚	信号名称
20	--	1	5V
19	5V	2	USB3_RX1-
18	USB3_RX2-	3	USB3_RX1+
17	USB3_RX2+	4	GND
16	GND	5	USB3_TX1-
15	USB3_TX2-	6	USB3_TX1+
14	USB3_TX2+	7	GND
13	GND	8	USB2_Data1-
12	USB2_Data2-	9	USB2_Data1+
11	USB2_Data2+	10	GND

2.3.6 COM 插针定义

RS232 串口, 2.54mm_2x5pin_ 第 10pin 空, 位置: COM3, COM4, COM5, COM6

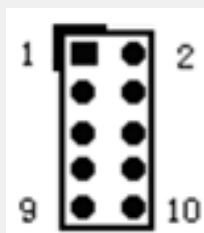

管脚	信号名称	管脚	信号名称
1	DCD	2	SIN
3	SOUT	4	DTR
5	GND	6	DSR
7	RTS	8	CTS
9	RI	10	NC

2.3.7 GPIO 插针定义

接口 8 位 GPIO 接口, 2.54mm_2x5pin, 位置: JGPIO

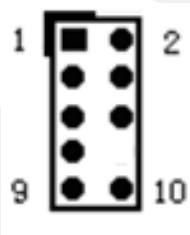

管脚	信号名称	管脚	信号名称
1	5V	2	GND
3	GPO 1	4	GPI 1
5	GPO 2	6	GPI 2
7	GPO 3	8	GPI 3
9	GPO 4	10	GPI 4

2.3.8 LPC_BUS debug 接口

插针 2.54mm_2x5pin : 位置: JLPC

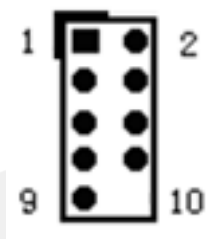

管脚	信号名称	管脚	信号名称
1	CLK	2	DATA0
3	RESET	4	DATA1
5	FRAME	6	DATA2
7	+3.3V	8	DATA3
9	GND	10	GND

2.3.9 FPANEL 前面板状态接口

2.54mm_2x5pin_ 第 10pin 空, 位置: FPANEL

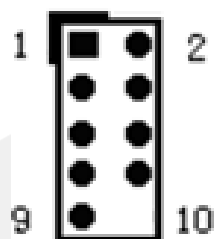

管脚	信号名称	管脚	信号名称
1	HDD LED+	2	PW LED+
3	HDD LED-	4	PW LED-
5	GND	6	PW Button
7	RESET	8	GND
9	BKL SW	10	--

2.3.10 AUDIO 插针

接口, 2.54mm_2x5pin_ 第 8pin 空, 位置: F_AUDIO

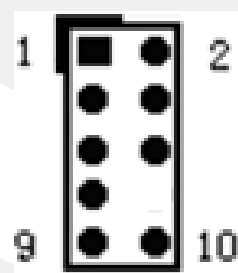

管脚	信号名称	管脚	信号名称
1	MIC L	2	GND
3	MIC R	4	PRESENCE
5	Line out R	6	MIC-JD
7	IO-SENSE	8	--
9	Line out L	10	LINE-JD

2.3.11 LPT 插针接口

2.0mm_2x13pin_ 黑色带框, 位置: LPT1

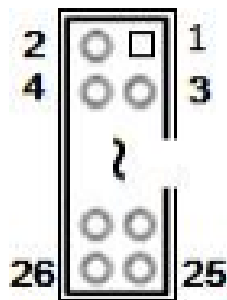

管脚	信号名称	管脚	信号名称
1	STB	2	AFD
3	PPD0	4	ERR
5	PPD1	6	INIT
7	PPD2	8	SLIN
9	PPD3	10	GND
11	PPD4	12	GND
13	PPD5	14	GND
15	PPD6	16	GND
17	PPD7	18	GND
19	ACK	20	GND
21	BUSY	22	GND
23	PE	24	GND
25	SLCT	26	NC

2.3.12 SPEAK 插针接口

2.0mm_2x1pin_ 白色带框, 位置: SPEAK



管脚	信号名称
1	5V
2	SPK

2.3.13 FAN 插针接口

2.54mm_4x1pin_ 白色, 位置: CPU_FAN, SYS_FAN1, SYS_FAN2

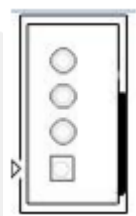

管脚	信号名称
1	GND
2	V12
3	FAN_TAC
4	FAN_CTL

2.3.14 AT 插针接口

2.54mm_2x1pin_ 白色, 位置: J_AT



管脚	信号名称
1	AT
2	SIO_JP6

2.4 插针定义

2.4.1 USB 2.0 插针接口 2.54mm_2x5pin_ 第 9pin 空, 位置: F_USB2, F_USB3

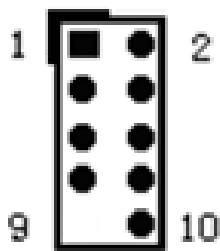

管脚	信号名称	管脚	信号名称
1	5V	2	5V
3	USB1_Data-	4	USB2_Data-
5	USB1_Data+	6	USB2_Data+
7	GND	8	GND
9	--	10	GND

2.4.2 USB 3.0 插针接口 2.0mm_2x10pin_蓝色带框_第 20pin 空, 位置: F_USB1

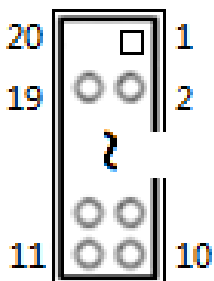

管脚	信号名称	管脚	信号名称
20	--	1	5V
19	5V	2	USB3_RX1-
18	USB3_RX2-	3	USB3_RX1+
17	USB3_RX2+	4	GND
16	GND	5	USB3_TX1-
15	USB3_TX2-	6	USB3_TX1+
14	USB3_TX2+	7	GND
13	GND	8	USB2_Data1-
12	USB2_Data2-	9	USB2_Data1+
11	USB2_Data2+	10	GND

2.4.3 COM 插针 RS232 串口, 2.54mm_2x5pin_ 第 10pin 空, 位置: JCOM2, JCOM3, JCOM4, JCOM5, JCOM6

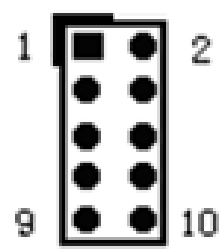

管脚	信号名称	管脚	信号名称
1	DCD	2	SIN
3	SOUT	4	DTR
5	GND	6	DSR
7	RTS	8	CTS
9	RI	10	NC

2.4.4 LPC_BUS debug 接口 2.54mm_2x5pin, 位置: JLPC

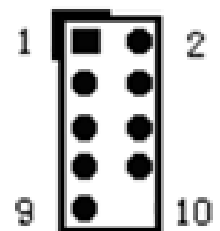

管脚	信号名称	管脚	信号名称
1	CLK	2	DATA0
3	RESET	4	DATA1
5	FRAME	6	DATA2
7	+3.3V	8	DATA3
9	GND	10	GND

2.4.5 GPIO 接口 2.0mm_2x5pin, 位置: GPIO1

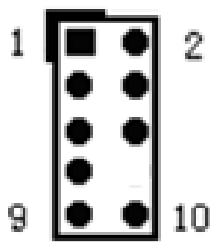

管脚	信号名称	管脚	信号名称
1	GND	2	5V
3	IO1	4	IO8
5	IO2	6	IO7
7	IO3	8	IO6
9	IO4	10	IO5

2.4.6 FPANEL 前面板状态接口 2.54mm_2x5pin_ 第10pin空, 位置: JFP1

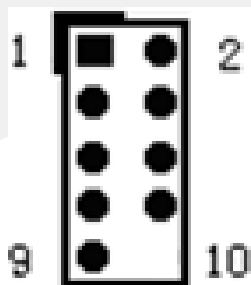

管脚	信号名称	管脚	信号名称
1	HDD LED+	2	PW LED+
3	SATA_LED#	4	GND
5	GND	6	PW Button
7	RESET	8	GND
9	NC	10	--

2.4.7 AUDIO 插针接口 2.54mm_2x5pin_ 第8pin空, 位置: F_AUDIO

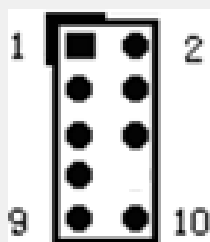

管脚	信号名称	管脚	信号名称
1	MIC L	2	GND
3	MIC R	4	PRESENCE
5	Line out R	6	MIC-JD
7	IO-SENSE	8	--
9	Line out L	10	LINE-JD

2.4.8 FAN 插针接口 2.54mm_4x1pin_ 白色, 位置: CPU_FAN, SYS_FAN1, SYS_FAN2

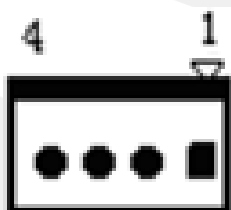

管脚	信号名称
1	GND
2	V12
3	FAN_TAC
4	FAN_CTL

第三章 BIOS 程序设置

AMI BIOS 刷新

BIOS 提供对硬件资源的底层驱动，是联系硬件和操作系统的桥梁。现在硬件和各种应用软件不断更新，当您的系统遇到问题时，例如系统不支持最新公布的 CPU 时，就需要升级您的 BIOS 了。

注意：

1. **升级 BIOS 只在遇到问题，必要的时候进行。**
2. **升级 BIOS 请使用我们驱动光盘内所附的 BIOS 读写程序，或者在相关网站下载更新版本的程序。**
3. **在升级过程中不要关闭电源或重新启动系统，以免造成您的 BIOS 资料将被损坏，系统也可能不能启动。**
4. **为防止意外发生，请您先备份当前的 BIOS 资料。**

AMI BIOS 描述

开机时，BIOS 会对主板上的硬件进行自我诊断，设定硬件时序参数等工作，最后才将系统控制权交给操作系统。如何正确的设定 BIOS 参数对系统是否稳定的工作及系统是否工作在最佳状态至关重要。

进入 BIOS 参数设置

电脑开机，在完成自我诊断后，屏幕上会显示出如下信息：Del->SETUP，此时您点击一下 Del 键，则 BIOS 在完成 IDE 等设备的侦测后会自动转入 SETUP 设置画面。

1. 打开系统电源或重新启动系统，显示器屏幕将出现自我测试的信息：
2. 当屏幕中间出现“Pressto enter setup”提示时，按下键，就可以进入 BIOS 设定程序。
3. 以方向键移动至您要修改的选项，按下<Enter>键即可进入该选项的子画面。
4. 使用方向键及<Enter>键即可修改所选项目的值，按回车键选择 BIOS 选项并修改。
5. 任何时候按下<Esc>键即可回到上一画面。

Setup Utility User Interface

This document describes BIOS Setup Utility user interface. (The following figures of setup utility are captured through serial redirection, so some difference exists to actual screens.)

3.1 Main Screen

The Main screen is the first screen that is displayed when the BIOS Setup is entered.

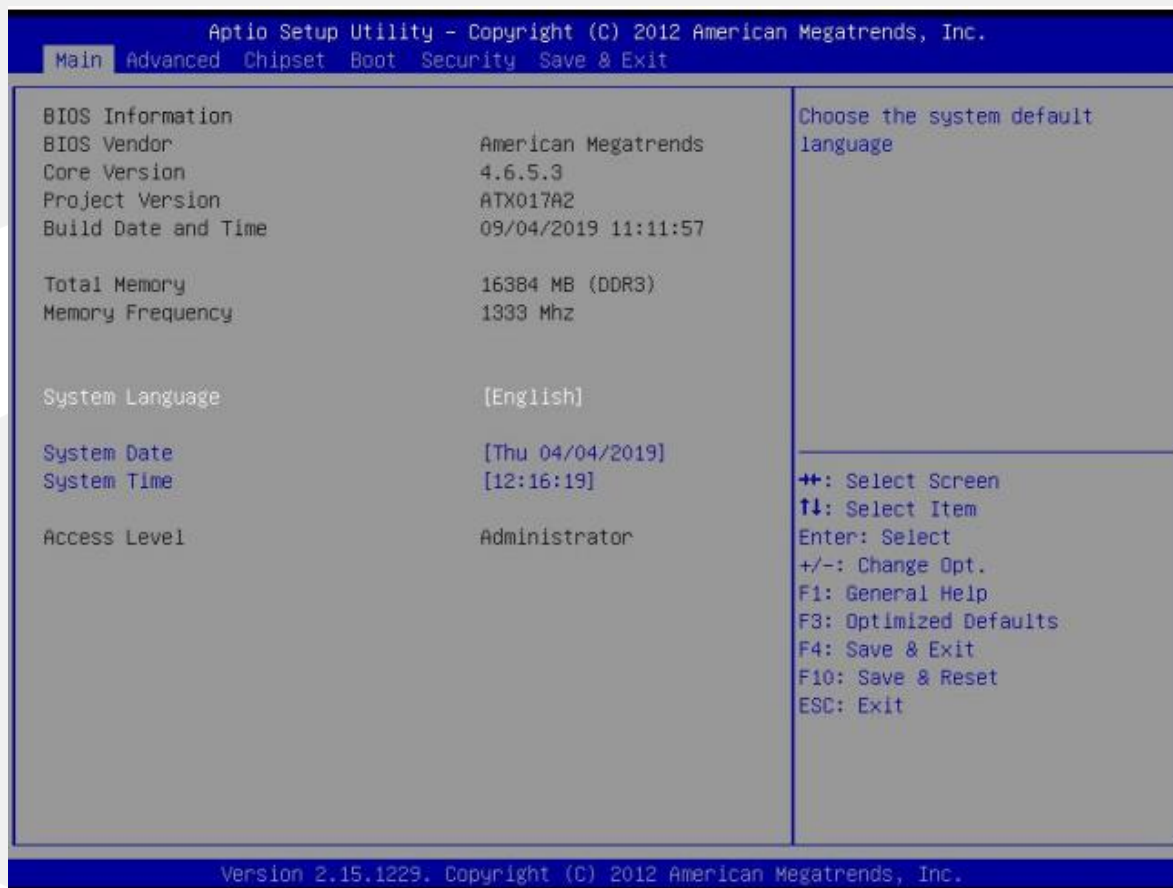

Setup Item	Options	Help Text	Comments
BIOS Information			
BIOS Vendor			Displays BIOS vendor.
Core Version			Displays the core version.
Project Version			Displays the current BIOS version: Format: AAAABBC AAAAA = Project name BB = BIOS revision C = Customer number
Build Date and Time			Displays the current BIOS build date.

Setup Item	Options	Help Text	Comments
Memory Information			
Total Memory			Displays the total physical memory installed in the system, in MB.
Memory Frequency			
System Language	English	Choose the system default language.	
System Date	[Day of week MM/DD/YYYY]	Set and display the Date.	
System Time	[HH:MM:SS]	Set and display the Time.	
Access Level			Displays password level that setup is running in: Administrator or User. With no passwords set, Administrator is the default mode.

3.2 Advanced Screen

The Advanced screen provides an access point to configure several options. On this screen, the user selects the option that is to be configured.

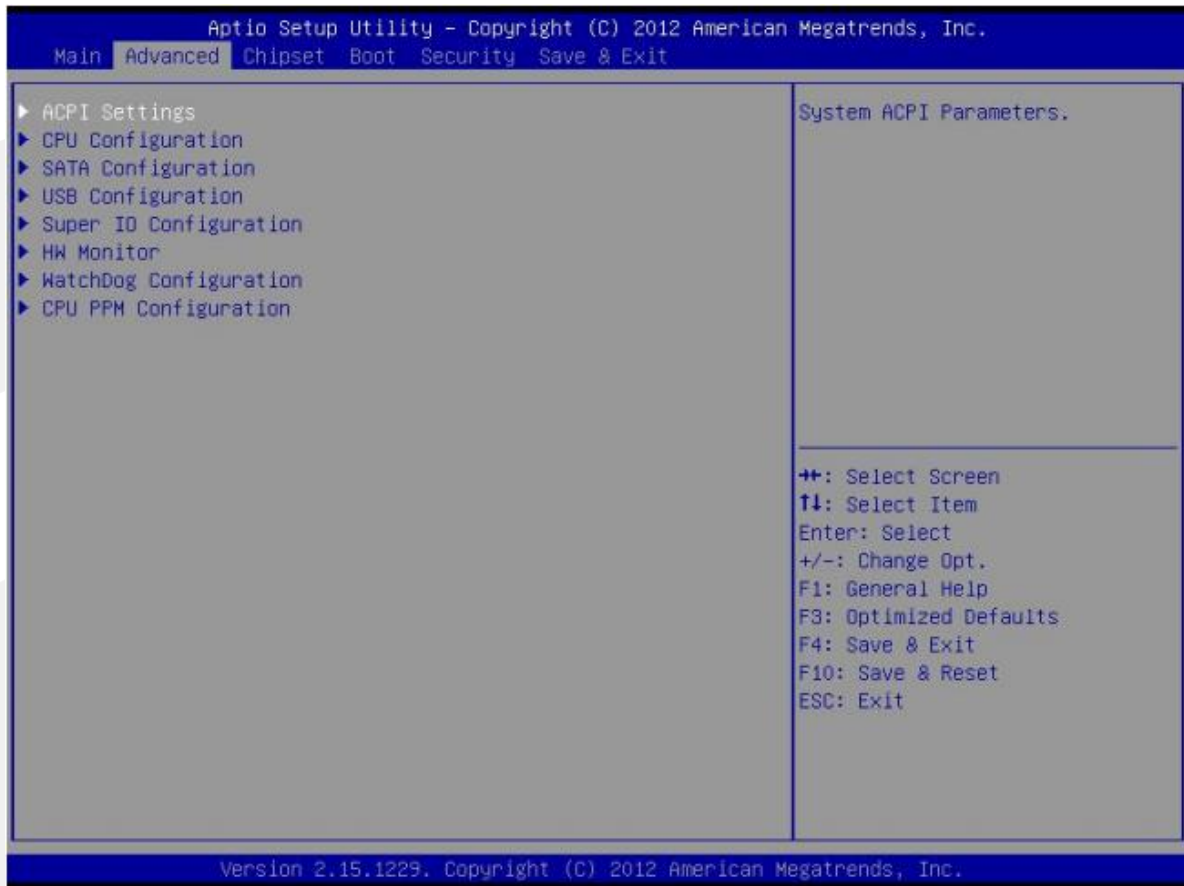

Setup Item	Options	Help Text	Comments
ACPI Settings		System ACPI Parameters.	
CPU Configuration			
SATA Configuration			
USB Configuration			CPU Configuration Parameters.
Super IO Configuration			SATA Devices Configuration.
HW Monitor		PC Health Status.	
WatchDog configuration		Set system watchdog parameters.	
CPU PPM configuration		CPU PPM configuration parameters.	

3.2.1 ACPI Settings Screen

The ACPI Settings screen allows the user to set the system ACPI parameters. To access this screen from the Main screen, choose **Advanced > ACPI Settings**.

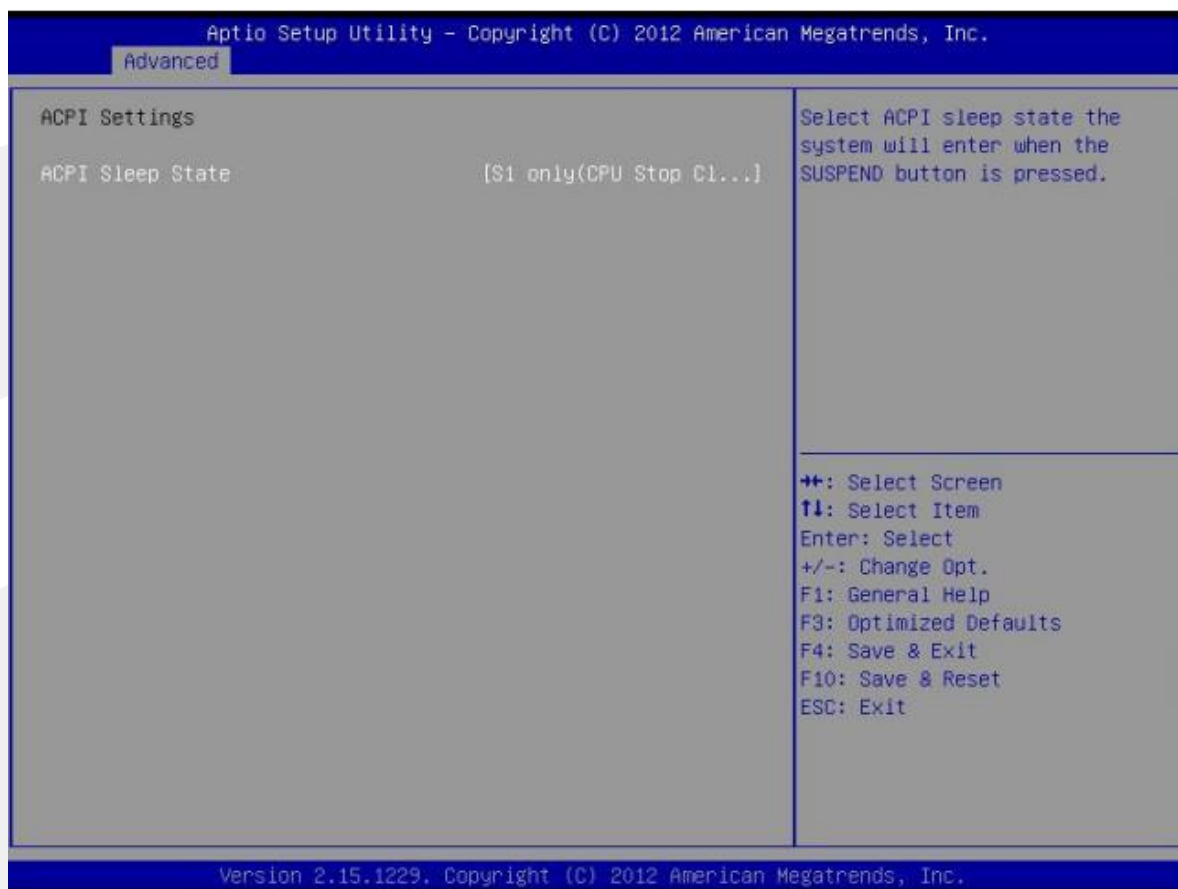

Setup Item	Options	Help Text	Comments
ACPI Settings			
ACPI Sleep State	Suspend Disabled S1 (CPU Stop Clock)	Select the highest ACPI sleep state the system will enter when the SUSPEND button is pressed.	

3.2.2 CPU Configuration Screen

The CPU Configuration screen allows the user to view the processor information, and to enable or disable processor options. To access this screen from the Main screen, choose **Advanced > CPU Configuration**.

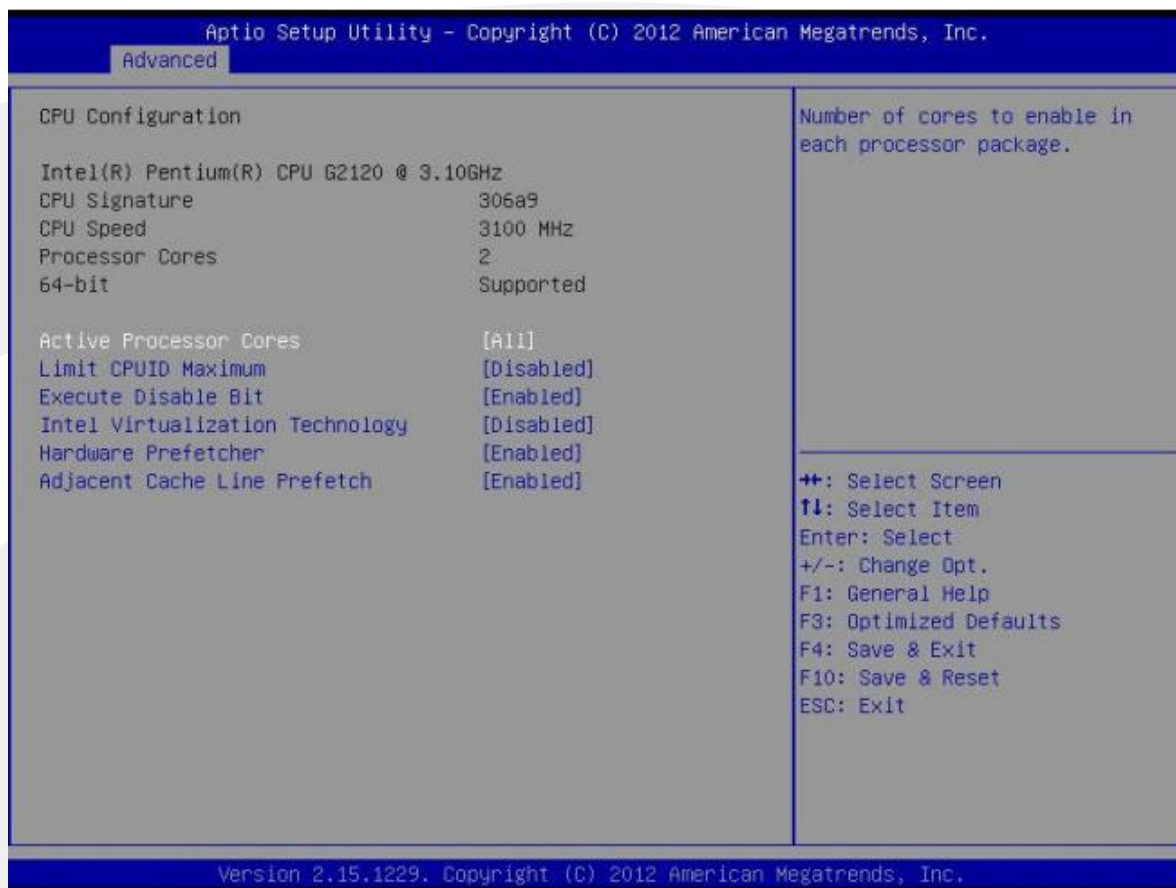

Setup Item	Options	Help Text	Comments
CPU Configuration			
Processor Type			Current frequency of the processor.
CPU Signature			
Processor Speed			Current frequency of the processor.
Processor Cores			Number of the Processor cores.
64-bit			If Current processor supports EM64T it shows supported.
Active Processor Cores	All	Number of cores to enable in each.	
Limit CPUID Maximum	Disabled Enabled	Disabled for Windows XP.	
Execute Disable Bit	Disabled Enabled	XD can prevent certain classes of malicious buffer overflow attacks when combined with a supporting OS.	

Setup Item	Options	Help Text	Comments
Intel Virtualization Technology	Disabled Enabled	When enabled, a VMM can utilize the additional hardware capabilities provided by Vander pool Technology.	
Hardware Prefetcher	Disabled Enabled	To turn on/off the MLC streamer pre-fetcher.	
Adjacent Cache Line Prefetch	Disabled Enabled	To turn on/off pre-fetching of adjacent cache lines.	

3.2.3 SATA Configuration Screen

The SATA Configuration screen allows the user to configure the SATA controller. To access this screen from the Main menu, choose **Advanced > SATA Configuration**.

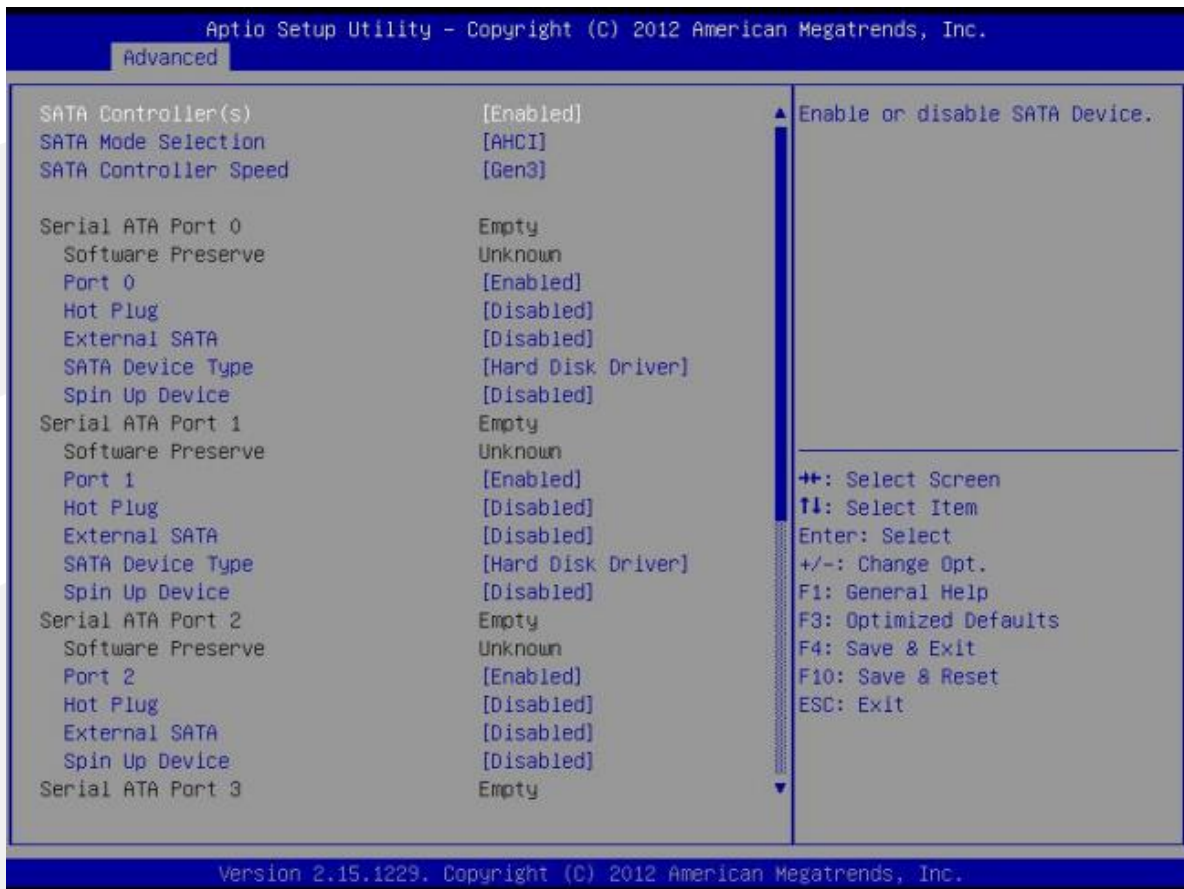

Setup Item	Options	Help Text	Comments
SATA Configuration			
SATA Controller(s)	Enabled Disabled	Enable or disable SATA Device.	
SATA Mode Selection	IDE AHCI RAID	Select IDE / AHCI/RAID Mode.	
SATA Controller Speed	Gen1 Gen2 Gen3	Indicates the maximum speed the SATA controller can support.	
SATA Port 0	Not Present /<Drive Info.>		If HDD present on the port, show HDD information.
SATA Port 1	Not Present /<Drive Info.>		NOTE: Port number supported is SKU specific.
SATA Port 2	Not Present /<Drive Info.>		
SATA Port 3	Not Present /<Drive Info.>		

Setup Item	Options	Help Text	Comments
SATA Port 4	Not Present /<Drive Info.>		NOTE: Port number supported is SKU specific.
SATA Port 5	Not Present /<Drive Info.>		

3.2.4 USB Configuration Screen

The USB Configuration screen allows the user to configure the USB controller options. To access this screen from the Main screen, choose **Advanced > USB Configuration**.

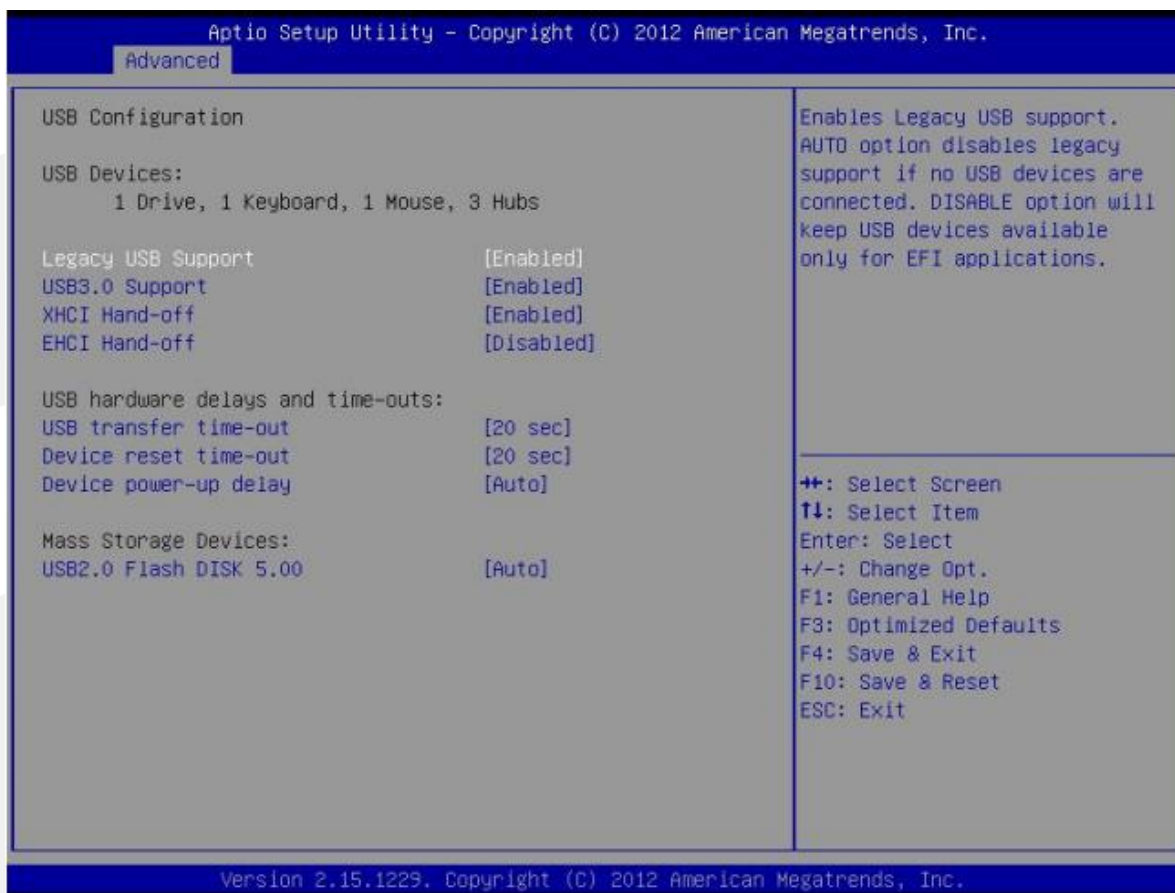

Setup Item	Options	Help Text	Comments
USB Configuration			
USB Devices			List USB devices in the system currently.
Legacy USB Support	Enabled Disabled Auto	Enables Legacy USB support. AUTO option disables legacy support if no USB devices are connected. DISABLE option will keep USB devices available only for EFI applications.	
USB3.0 Support	Enabled		
XHCI Hand-off	Enabled		
EHCI Hand-off	Enabled		
USB hardware delays and time-outs			
USB transfer time-out			
Device reset time-out			
Device power-up delay	Auto		

Setup Item	Options	Help Text	Comments
Mass Storage Devices			If Mass storage devices installed, this item lists them and allows user to set emulation type.
<USB Mass Device Name>	Auto Floppy Forced FDD Hard Disk CD-ROM	Mass storage device emulation type. 'AUTO' enumerates devices according to their media format. Optical drives are emulated as 'CDROM', drives with no media will be emulated according to a drive type.	'AUTO' enumerates devices less than 530MB as floppies.

3.2.5 Super IO Configuration Screen

The Super IO Configuration screen allows the user to configure the Serial Port 0. To access this screen from the Main screen, choose **Advanced > Super IO Configuration**.

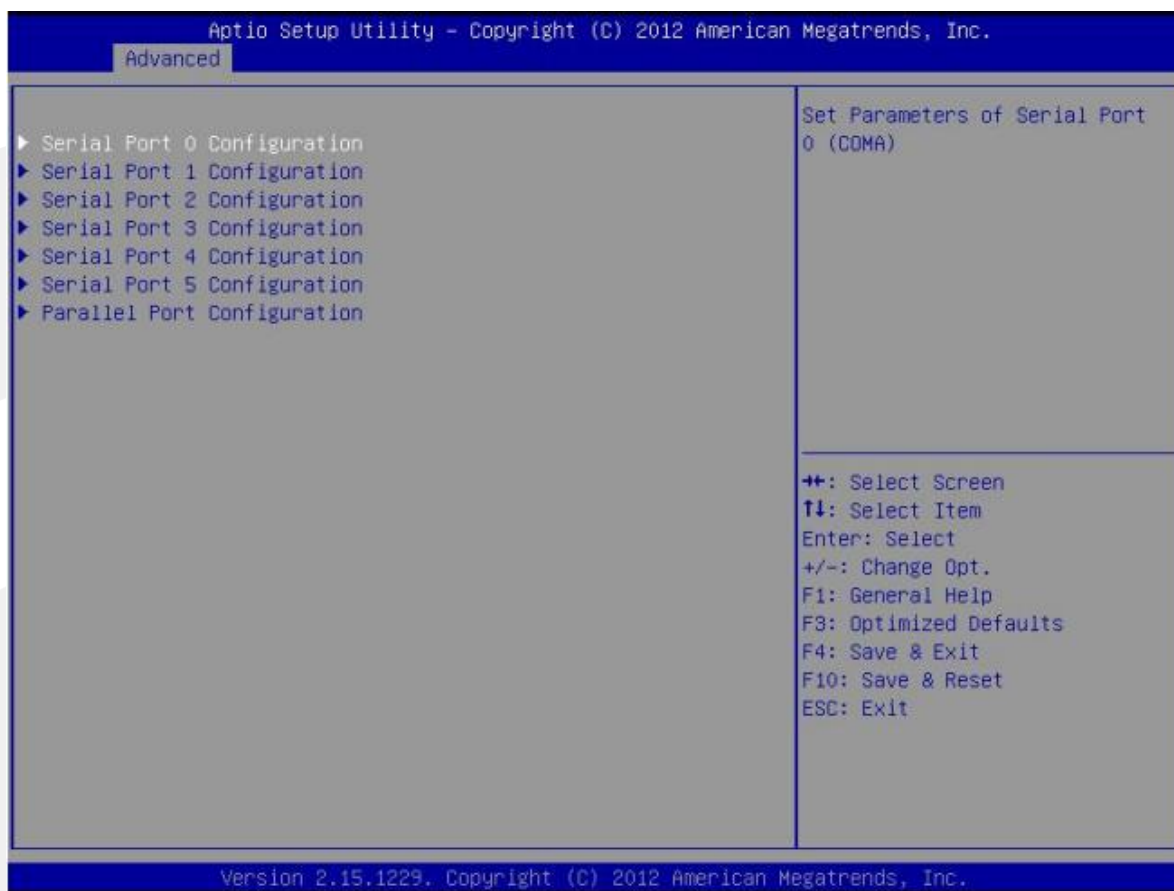

Setup Item	Options	Help Text	Comments
Super IO Configuration			
Super IO Chip			Shows Current Super IO Chip name.
Serial Port 0 Configuration		Set Parameters of Serial Port 0 (COMA).	
Serial Port 1 Configuration		Set Parameters of Serial Port 1 (COMB).	Optional. Only when more than one serial ports supported.
Serial Port 2 Configuration		Set Parameters of Serial Port 2 (COMC).	Optional. Only when more than one serial ports supported.
Serial Port 3 Configuration		Set Parameters of Serial Port 3 (COMD).	Optional. Only when more than one serial ports supported.
Serial Port 4 Configuration		Set Parameters of Serial Port 4 (COME).	Optional. Only when more than one serial ports supported.
Serial Port 5 Configuration		Set Parameters of Serial Port 5 (COMF).	Optional. Only when more than one serial ports supported.
Parallel Port Configuration		Set Parameters of Parallel Port (LPT/LPTE).	Optional. Only when more than one serial ports supported.

3.2.5.1 Serial Port X Configuration Screen

The Serial Port 0 Configuration Screen allows the user to configure the Serial Port 0 (COMA). To access this screen from the Main screen, choose **Advanced > Super IO Configuration > Serial Port 0 Configuration**.



Setup Item	Options	Help Text	Comments
Serial Port 0 Configuration			
Serial Port	Disabled Enabled	Enable or Disable Serial Port(COM).	
Device Settings			Shows Current IO and IRQ settings.
RS485 Direction Control	Disabled Enabled	RTS asserted for RS485 automatic direction control when transmitting data to or receiving data from RS485 transceiver.	

3.2.6 Hardware Monitor

The Hardware Monitor screen shows the PC health status include temperature, fan speed, and voltage. To access this screen from the Main screen, choose **Advanced > Hardware Monitor**.

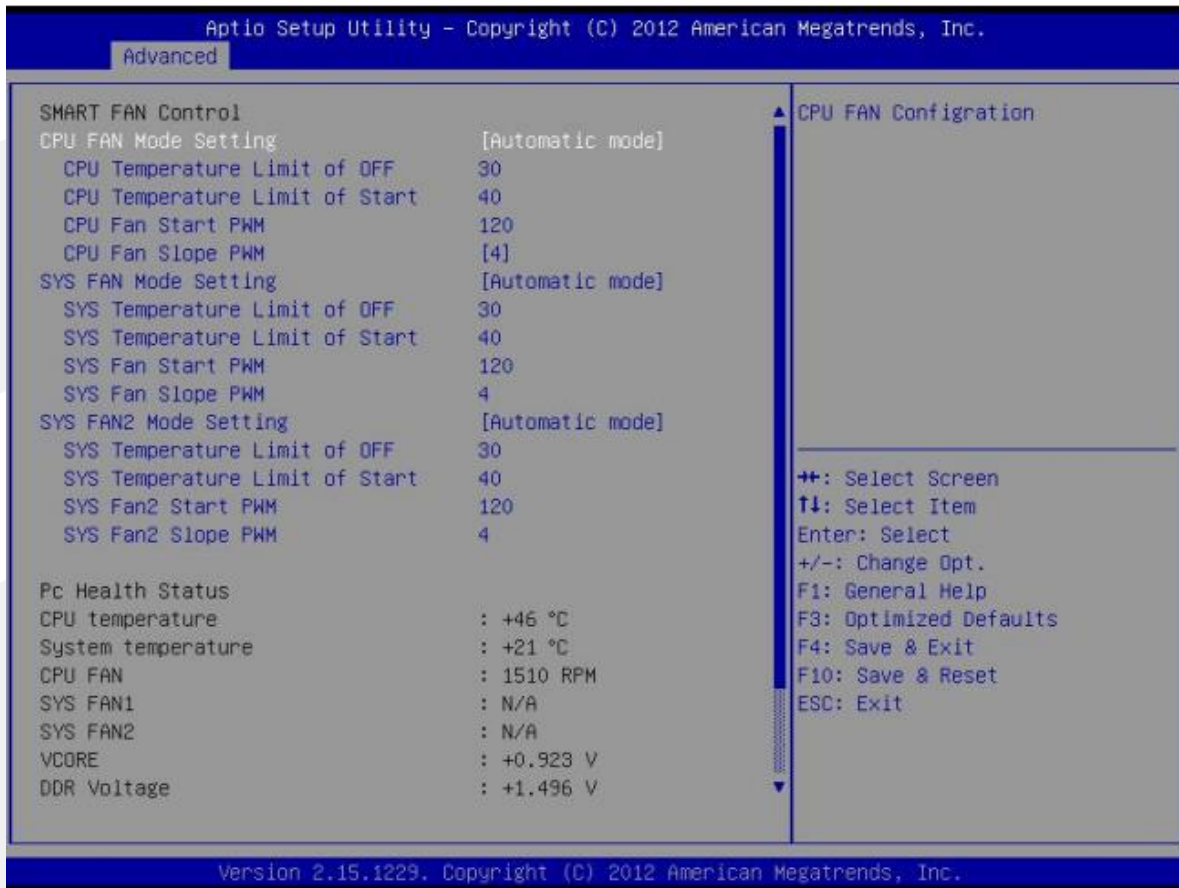

Setup Item	Options	Help Text	Comments
Hardware Monitor			
CPU Fan Mode Setting	Full on Mode Automatic mode Manual mode	CPU Fan control mode select.	When Manual mode selected, Manual PWM Setting shows to set FAN PWM Duty.
SYS Fan Mode Setting	Full on Mode Automatic mode Manual mode	SYS Fan control mode select.	When Manual mode selected, Manual PWM Setting shows to set FAN PWM Duty.
SYS Fan2 Mode Setting	Full on Mode Automatic mode Manual mode	SYS Fan2 control mode select.	When Manual mode selected, Manual PWM Setting shows to set FAN PWM Duty.
PC Health Status			
CPU Temperature			Shows Current CPU temperature. NOTE: Sometimes not the actual temperature value, just indicates temperature tolerance limitation.

Setup Item	Options	Help Text	Comments
SYS Temperature			Shows Current system temperature.
CPU Fan			Information only.
SYS FAN1			
SYS FAN2			
VCORE			
DDR VOLTAGE			
12VCC			
5VCC			
3.3VCC			

3.2.7 Watchdog configuration

Watchdog configuration allows the user to set System WatchDog Parameters. To access this screen from the Main screen, choose **Advanced > Watchdog configuration**.

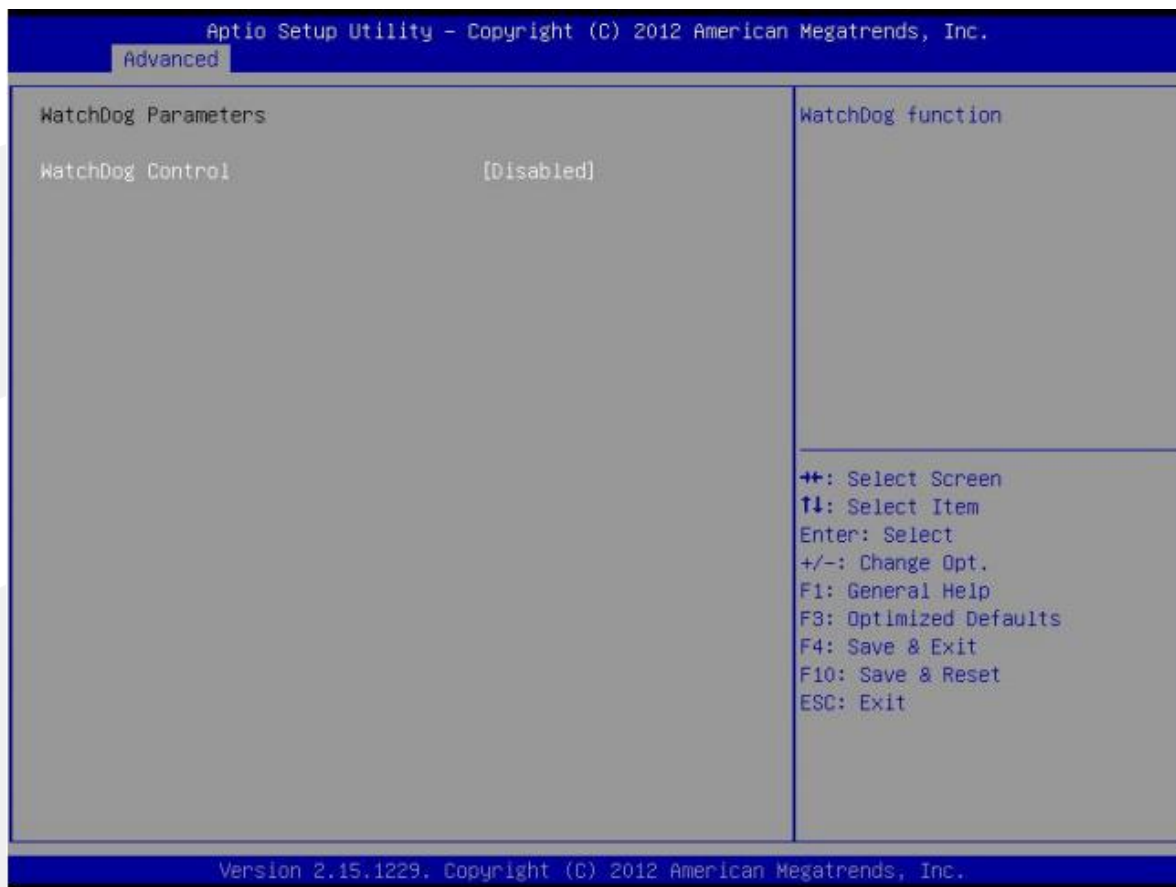

Setup Item	Options	Help Text	Comments
WatchDog Configuration			
WatchDog Control	Disabled Enabled	WatchDog function.	
WDT Timeout Mode	Minute Second	WDT Timeout Mode Select: Minute or Second.	Warning: When watchdog timeout occurred, SIO will reset system. If Minute or Second selected, Watchdog timeout was always enabled, unless disabled by other operation or resetting in Setup Utility.
WatchDog TimeOut Value	1	Fill WatchDog TimeOut Value,0 means disabled.	

3.2.8 CPU PPM configuration

Watchdog configuration allows the user to set System WatchDog Parameters. To access this screen from the Main screen, choose **Advanced > Watchdog configuration**.

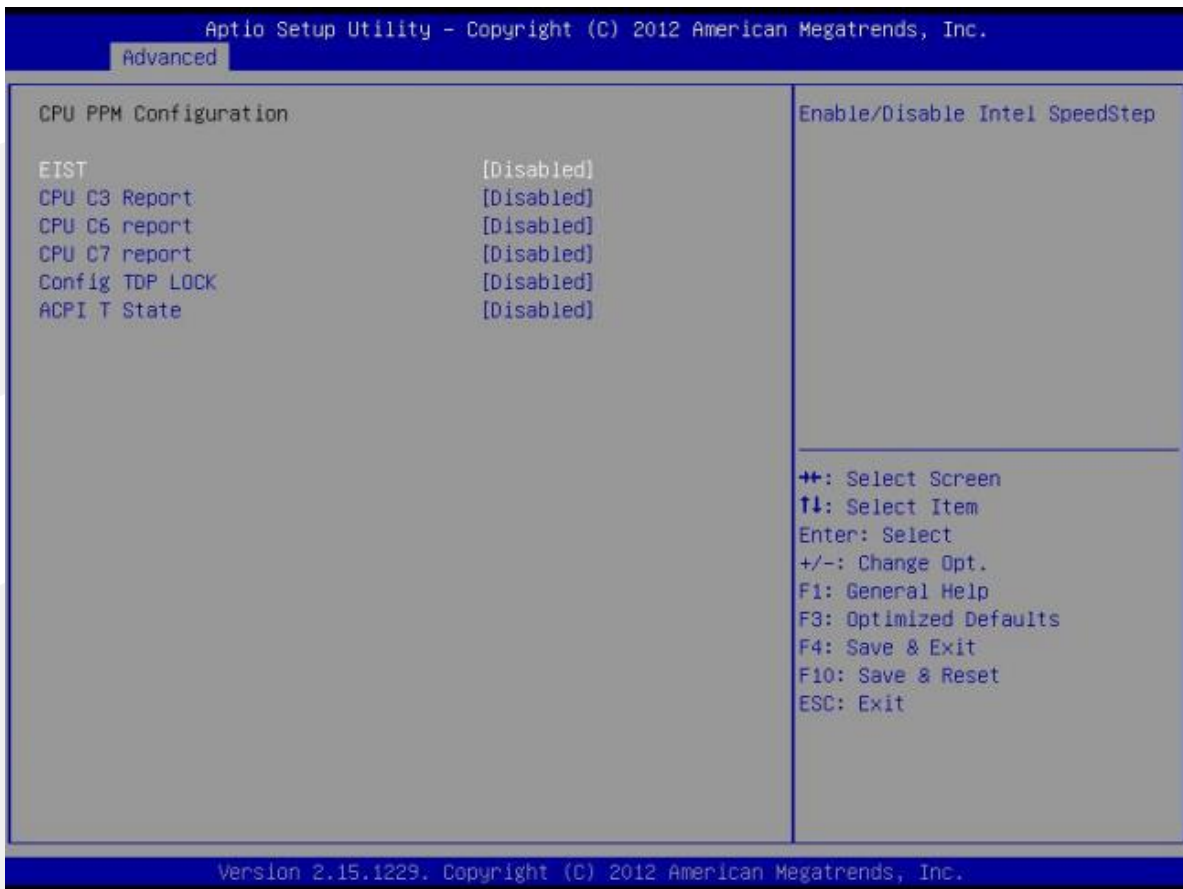

Setup Item	Options	Help Text	Comments
CPU PPM Configuration			
EIST	Disabled Enabled	Enable/Disable Intel SpeedStep.	
CPU C3 Report	Disabled Enabled	Enable/Disable CPU C3(ACPI C2) report to OS.	
CPU C6 report	Disabled Enabled	Enable/Disable CPU C6(ACPI C3) report to OS.	
CPU C7 report	Disabled Enabled	Enable/Disable CPU C7(ACPI C3) report to OS.	
Config TDP LOCK	Disabled Enabled	Lock the Config TDP Control register.	
ACPI T State	Disabled Enabled	Enable/Disable ACPI T state support.	

3.3 Chipset Screen

The Chipset screen provides an access point to configure North Bridge and South Bridge. To access this screen from the Main screen, press the right arrow until the Chipset screen is chosen.



Setup Item	Options	Help Text	Comments
Chipset Screen			
PCH-IO Configuration		PCH Parameters.	
System Agent (SA) Configuration		System Agent (SA) Parameters.	

3.3.1 System Agent (SA) Configuration

The North Bridge screen allows the user to view details about the system memory DDR-3 DIMMs that are installed. To access this screen from the Main screen, choose **Chipset > System Agent (SA) Configuration**.

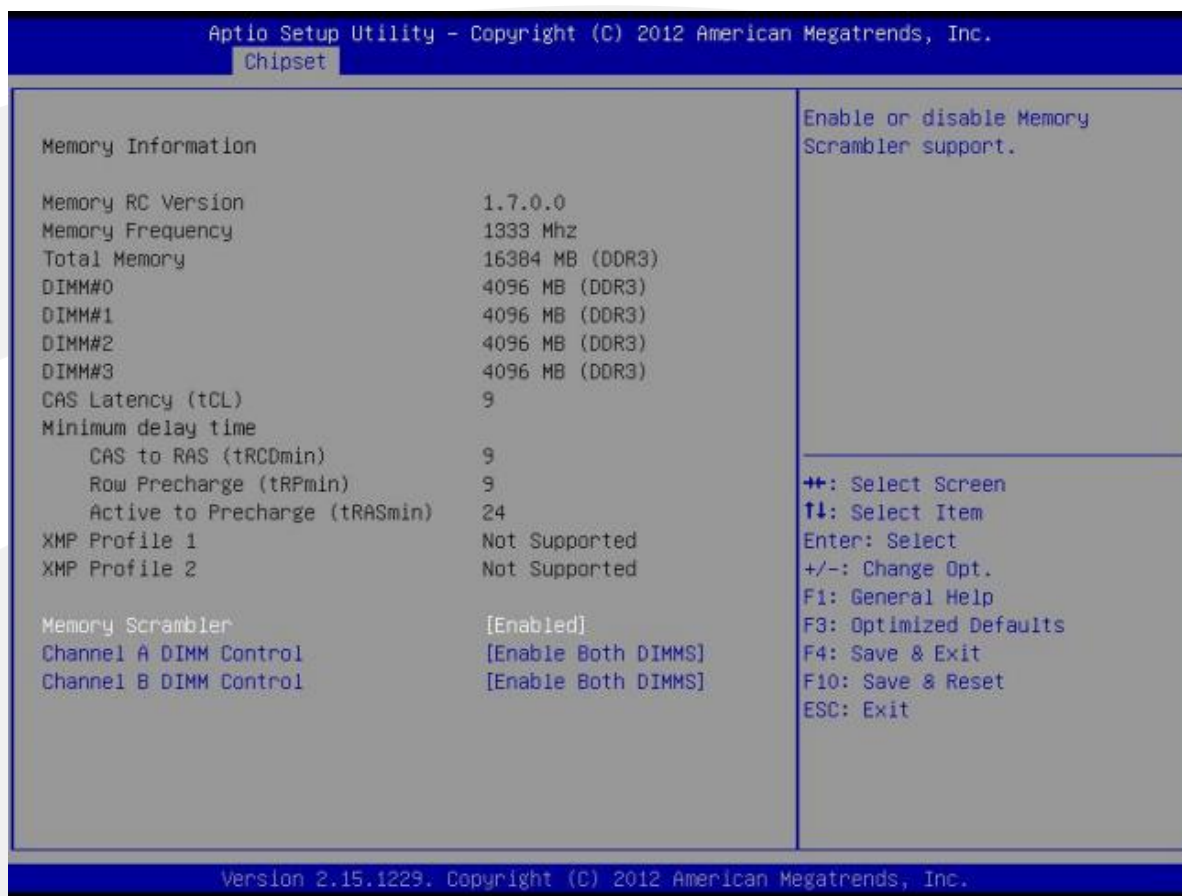

Setup Item	Options	Help Text	Comments
System Agent (SA) Configuration			
Memory Information			
Memory RC Version			
Memory Frequency			
Total Memory			Shows total memory in the System.
DIMM#0			Shows Memory populating status.Slot number supported is SKU specific.
DIMM#1			
DIMM#2			
DIMM#3			
CAS Latency (tCL)			
Minimum delay time			
CAS to RAS (tRCDmin)			
Row Precharge (tRPmin)			
Active to Precharge (tRASmin)			

Setup Item	Options	Help Text	Comments
Memory Scrambler	Enabled Disabled	Enable or disable Memory Scrambler support.	
Channel A DIMM Control	Enable Both DIMMS Disable DIMM0 Disable DIMM1 Disable Both DIMMS	Enable or disable dimms on channel A.	
Channel B DIMM Control	Enable Both DIMMS Disable DIMM0 Disable DIMM1 Disable Both DIMMS	Enable or disable dimms on channel B.	

3.3.2 South Bridge Screen

The South Bridge Screen allows user to set SB chipset configuration. To access this screen from the Main screen, choose **Chipset > South Bridge**.

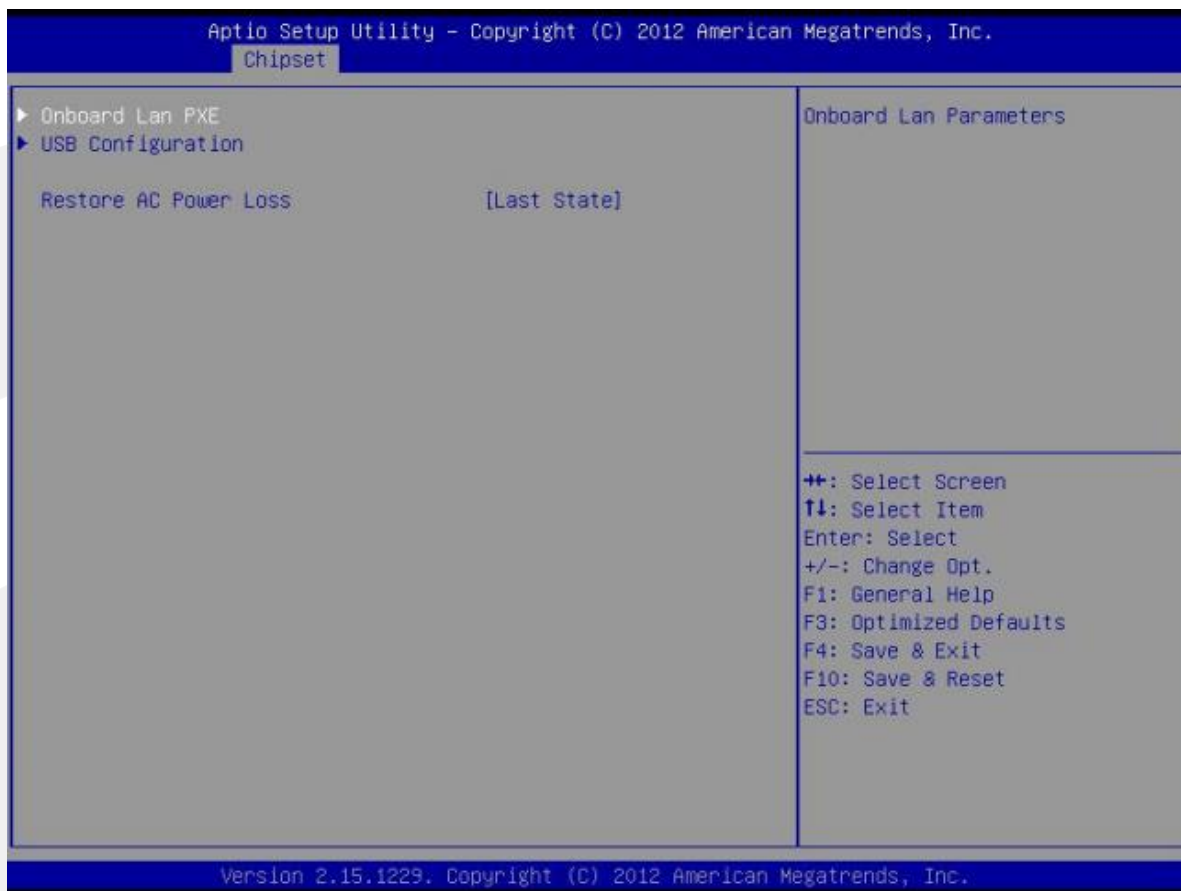

Setup Item	Options	Help Text	Comments
South Bridge Screen			
Onboard Lan PXE		Onboard Lan Parameters.	
USB Configuration		USB configuration settings.	
Restore AC Power Loss	Power off Power on Last State	Restore AC Power Loss help.	

3.4 Boot Screen

The Boot screen displays any bootable media encountered during POST, and allows the user to configure desired boot device. To access this screen from the Main screen, choose **Boot**.

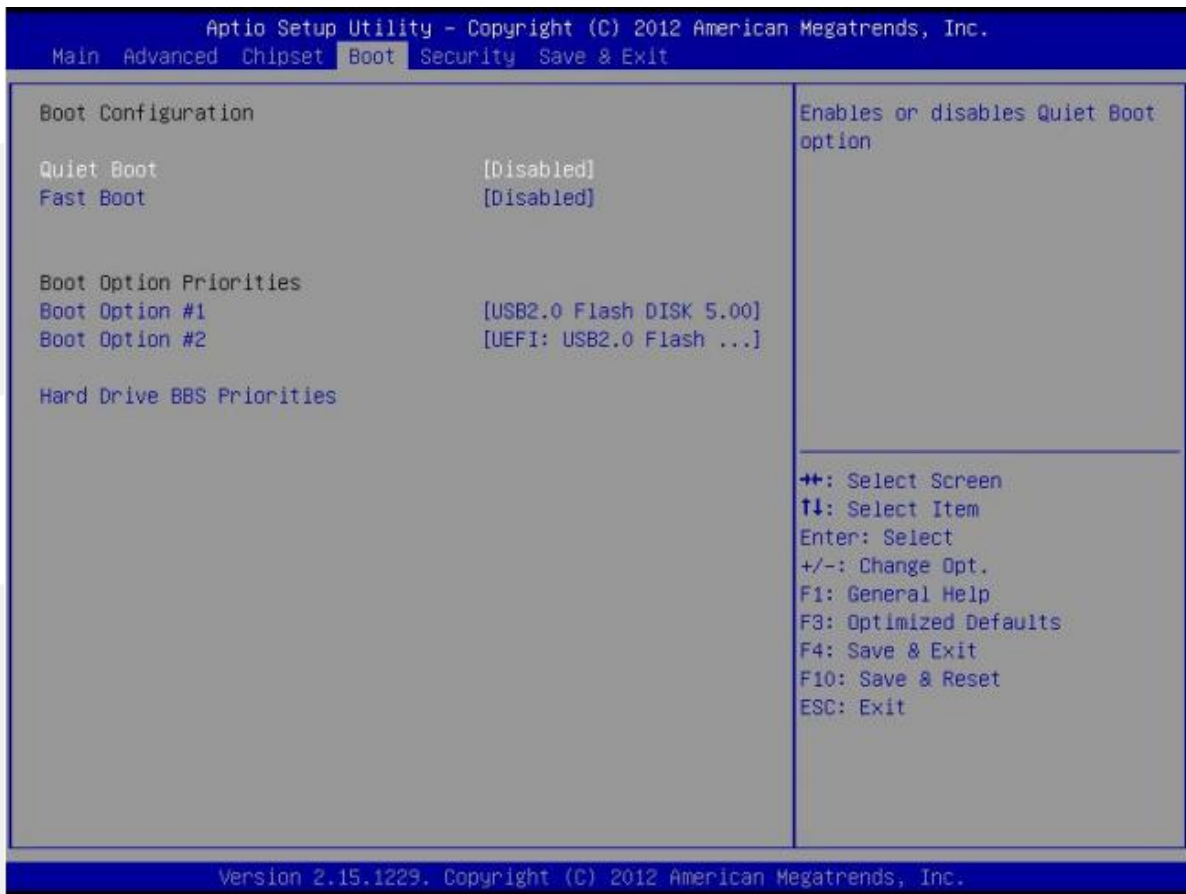

Setup Item	Options	Help Text	Comments
Boot Configuration			
Quiet Boot	Disabled Enabled	Enables/Disables Quiet Boot option.	
Fast Boot	Disabled		
Boot Option Priorities			
Boot Option #1		Sets the system boot order.	Note: Showed When boot devices existed.
Boot Option #2		Sets the system boot order.	
Hard Drive BBS Priorities		Set the order of the legacy devices in this group.	Set boot order in each group of the same kind, such as HDD, network.

3.5 Security Screen

The Security screen allows the user to enable and set the user and administrative password. To access this screen from the Main screen, choose **Security**.

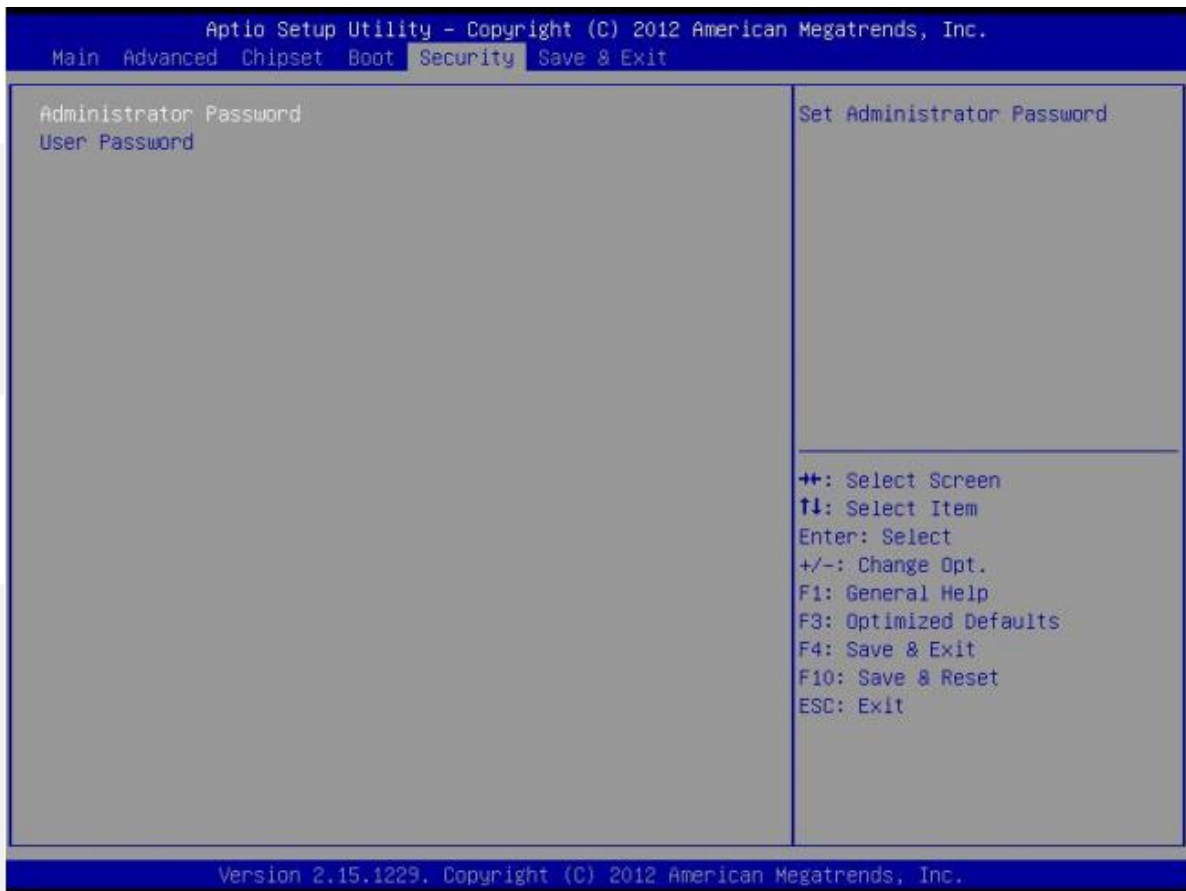

Setup Item	Options	Help Text	Comments
Security Screen			
Administrator Password		Set Setup Administrator Password.	NOTE: Password can be cleared when blank password set. If ONLY the Administrator's password is set, then this only limits access to Setup and is only asked for when entering Setup. If ONLY the User's password is set, then this is a power on password and must be entered to boot or enter Setup. In Setup the User will have Administrator rights.
User Password		Set User Password.	

3.6 Save & Exit Screen

The Save & Exit screen allows the user to choose whether to save or discard the configuration changes made on the other screens. It also allows the user to restore the server to the factory defaults or to save or restore them to set of user-defined default values.

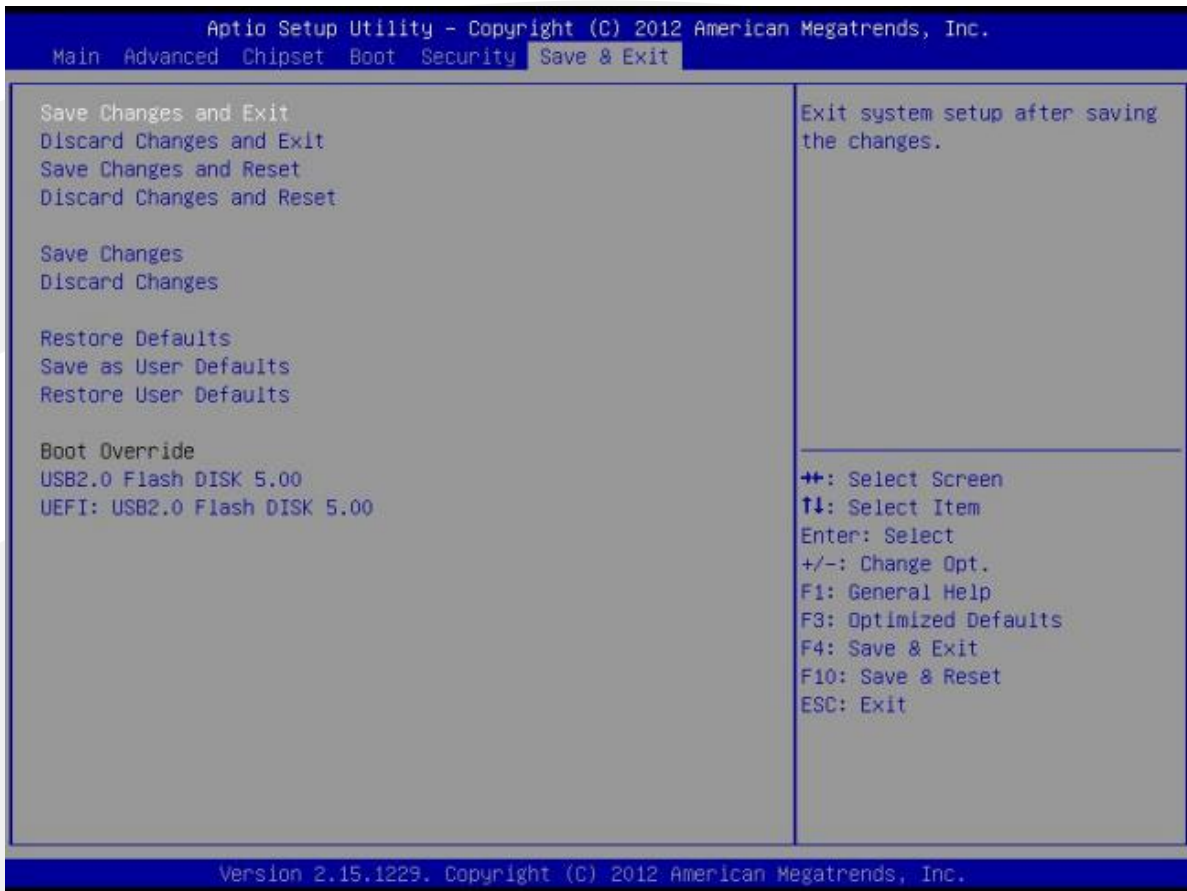

Setup Item	Options	Help Text	Comments
Save & Exit Screen			
Save Changes and Exit		Exit system setup after saving the changes.	User is prompted for confirmation only if any of the setup fields were modified.
Discard Changes and Exit		Exit system setup without saving any changes.	
Save Changes and Reset		Save Changes done so far to any of the setup options.	User is prompted for confirmation only if any of the setup fields were modified.
Discard Changes and Reset		Discard Changes done so far to any of the setup options.	
Restore Defaults		Restore/Load Defaults values for all the setup options.	
Save as User Defaults		Save the changes done so far as User Defaults.	
Restore User Defaults		Restore the User Defaults to all the setup options.	

附录

附一：Watchdog 编程指引

Watchdog 参考代码 (ASM)

我们可以操作端口来实现对看门狗的操作。可以通过对相应端口写数据来操作端口，实现 Watchdog Timer 的不同功能。

```
void main()
int indexp = 0x2e, datap = 0x2f;

outportb(indexp, 0x87);

outportb(indexp, 0x01); //unlock
outportb(indexp, 0x55);
outportb(indexp, 0x55);

outportb(indexp, 0x07);
outportb(datap, 0x07);

outportb(indexp, 0x72);
outportb(datap, 0xc0); //set second
/*outportb(datap, 0x40); set minute*/

outportb(indexp, 0x73);
outportb(datap, 0x03); //set 3 seconds

outportb(indexp, 0x02);
outportb(datap, 0x02); //lock
```

附二：术语表

ACPI 高级配置和电源管理

ACPI 规范允许操作系统控制计算机及其附加设备的大部份电能。

BIOS 基本输入/输出系统

是在 PC 中包含所有的输入/输出控制代码界面的软件。它在系统启动时进行硬件检测，开始操作系统的运作，在操作系统和硬件之间提供一个界面。BIOS 是存储在一个只读存储器芯片内。

BUS 总线

在计算机系统中，不同部件之间交换数据的通道，是一组硬件线路。我们所指的 BUS 通常是 CPU 和主内存元件内部的局部线路。

Chipset 芯片组

是为执行一个或多个相关功能而设计的集成芯片。我们指的是由南桥和北桥组成的系统级芯片组，他决定了主板的架构和主要功能。

CMOS 互补金属

氧化物半导体。是一种被广泛应用的半导体类型。它具有高速、低功耗的特点。我们指的 CMOS 是在主板上的 CMOS RAM 中预留的一部份空间，用来保存日期、时间、系统信息和系统参数设定信息等。

COM 串口

一种通用的串行通信接口，一般采用标准 DB9 公头接口连接方式。

DIMM 双列直插式内存模块

是一个带有内存芯片组的小电路板。提供 64bit 的内存总线宽度。

DRAM 动态随机存取存储器

是一个普通计算机的通用内存类型。通常用一个晶体管和一个电容来存储一个位。随着技术的发展，DRAM 的类型和规格已经在计算机应用中变得越来越多样化。例如现在常用的就有 SDRAM、DDR SDRAM 和 RDRAM。

L2c

Inter-Integrated Circuit 总线是一种由 PHILIPS 公司开发的两线式串行总线，用于连接微控制器及其外围设备。

LAN 局域网络接口

一个小区域内相互关联的计算机组成的一个计算机网络，一般是在一个企事业单位或一栋建筑物。局域网一般由服务器、工作站、一些通信链接组成，一个终端可以通过电线访问数据和设备的任何地方，许多用户可以共享昂贵的设备和资源。

LED 发光二极管

一种半导体设备，当电流流过时它会被点亮，通常用来把信息非常直观地表示出来，例如表示电源已经导通或硬盘驱动器正在工作等。

PnP 即插即用

允许 PC 对外接设备进行自动配置，不用用户手动操作系统就可以自己工作的一种规格。为实现这个特点，BIOS 支持 PnP 和一个 PnP 扩展卡都是必需的。

POST 上电自检

在启动系统期间，BIOS 会对系统执行一个连续的检测操作，包括检测 RAM，键盘，硬盘驱动器等，看它们是否正确连接和是否正常工作。

PS/2

由 IBM 发展的一种键盘和鼠标连接的接口规范。PS/2 是一个仅有 6PIN 的 DIN 接口，也可以用以连接其他的设备，比如调制解调器。

USB 通用串行总线

一种适合低速外围设备的硬件接口，一般用来连接键盘、鼠标等。一台 PC 最多可以连接 127 个 USB 设备，提供一个 12Mbit/s 的传输带宽；USB 支持热插拔和多数数据流功能即在系统工作时可以插入 USB 设备，系统可以自动识别并让插入的设备正常。

深圳智锐通科技有限公司
Shenzhen Zrt Co., Ltd.



智锐通公众号

&



智锐通抖音号

- 集团总部：深圳市宝安区碧桂园凤凰智谷A栋21楼
- 北京分公司：北京市昌平区科兴西路106号院2号楼5层
- 南京分公司：南京市江宁区万科都荟天地B2栋7楼
- 苏州分公司：苏州市虎丘区港龙城市广场4栋13楼
- 成都分公司：成都市武侯区世纪百合尚寓3栋10楼
- 400-838-6869