

ECM-C132

COM-Express Type6 核心板
USER' Manual V1.1

USER'S MANUAL 用户手册

声明

本使用说明书内容如有变更，恕不另行通知。本公司并不对本使用说明书之适用性，适合做某种特殊用途之使用或其他任何事项做任何明示，或做其他形式之保证或担保。因此本公司将不对手册内容之错误，或因增减展示或以其他方式使用本手册所造成之直接，间接，突发性过、或继发性之损害负任何责任。

版权声明：

版权所有----深圳智锐通科技有限公司。未经本公司许可或依著作权法之规定许准，不得复制，节录和翻译使用说明书之任何内容。

安全须知

1	产品使用前，务必仔细阅读产品说明书。
2	对未准备安装的板卡，应将其保存在防静电保护袋中。
3	在从包装袋中拿板卡前，应将手先置于接地金属物体上一会儿，以释放身体及手中的静电。
4	在拿板卡时，需佩带静电保护手套，并且应该养成只触及边缘部份的习惯。
5	主板与电源连接时，请确认电源电压。
6	为避免人本被电击或产品被损坏，在每次对主板、板卡进行拔插或生新配置时须先关闭交流电源或将交流电源线从电源插座中拔掉。
7	在对板卡进行搬动前，先将交流电源线从电源插座中拔掉。
8	当您需连接或拔除任何设备前，须确定所有的电源线事先已被拔掉。
9	为避免频繁开关机对产品造成不必要的损伤,关机后,应至少等待30秒后再开机。
10	设备在使用过程时出现异常情况，请找专业人员处理。

目录

第一章 产品介绍.....	6
1.1 产品规格.....	6
1.2 驱动.....	8
1.3 功能框图.....	8
1.4 产品料号.....	9
1.5 产品照片.....	10
1.6 散热器.....	11
第二章 安装说明.....	12
2.1 尺寸图与安装流程.....	12
2.2 硬件安装.....	15
2.3 跳线功能设置.....	15
2.4 接口引脚定义.....	15
2.4.1 CPU_FAN1 引脚定义.....	15
2.4.2 SW1 引脚设定 (IT8659 Power-On Strapping).....	15
2.4.3 AT_SW1 引脚设定 (ATX/AT 模式设定).....	15
2.4.4 COM-E 220PIN 引脚定义.....	16
第三章 BIOS 程序设置.....	20
3.1 Main Screen.....	21
3.2 Advanced Screen.....	23
3.2.1 CPU Configuration Screen.....	24
3.2.2 Trusted Computing.....	27
3.2.3 ACPI Settings Screen.....	28

3.2.4 Super IO Configuration.....	29
3.2.4.1 Serial PortX Configuration.....	30
3.2.5 Hardware Monitor.....	31
3.2.6 SATA Configuration.....	32
3.2.7 USB Configuration.....	33
3.2.8 Network Stack Configuration.....	35
3.2.9 CSM Configuration.....	36
3.2.10 NVMe Configuration.....	37
3.2.11 Watchdog Configuration.....	38
3.2.12 LVDS Panel.....	39
3.3 Chipset Screen.....	40
3.3.1 System Agent (SA) Configuration.....	41
3.3.2 PCH-IO Configuration.....	44
第四章 Electrical Specifications.....	50
4.1 Input Power - General Considerations.....	50
4.2 Input Power - Current Load.....	51
4.3 Input Power - Sequencing.....	52
4.4 Input Power - Rise Time.....	53
4.5 Signal Integrity Requirements.....	54
第五章 故障问题排除.....	55
附录.....	56
附一：术语表.....	56

第一章 产品介绍

1.1 产品规格

Model		ECM-C132					
配置 Item	规格 Specification	描述 Describe					
处理器 Processor System	处理器 CPU	7305E	i2- 1215U	i5- 1250PE	i3- 1315U	i5- 1350PE	i7- 1360P
	内核数 Core Number	5C	6C	12C	6C	12C	12C
	线程 Total Threads	5T	8T	16T	8T	16T	16T
	最高主频 Max. Speed	1.0GHz	4.4GHz	4.4GHz	4.5GHz	4.6GHz	5.0GHz
	二级缓存 L2 Cache	8M	10M	12M	10M	12M	18M
	功耗 TDP (W)	15W	15W	28W	15W	28W	28W
	指令集 Instruction Set Extensions	SSE4.1, SSE4.2, AVX2					
	BIOS	AMI UEFI 256Mbit					
扩展插槽 Expansion Slot	PCI Express	PEG: PCIe Gen4, 12 lanes (H series), Bitfurcate to 1 x8 PEG: PCIe Gen4, 4 lanes (P/U series), Bitfurcate to 1 x4 PCIe: PCIe Gen3, 4 lanes max up to 6 end devices, Default 5 lanes (5 x1, 2 x2 + 1 x1), Option 2 x4, 1 x4 + 2 x2 (Co-lay with SATA & Ethernet)					
内存 Memory	规格 Technology	DDR5 Non-ECC					
	最大容量 Max. Capacity	64G 4800MH/s					
	插槽 Socket	2 x SO-DIMM					
显示 Display	最多显示 Multiple Display	4 Ports					
	控制器 Controller	1 x LVDS Dual Chanel(Optional eDP) 3 x DDI configurable HDMI/DisplayPort 1 x DDI configurable VGA					
	分辨率 Resolution	LVDS:1920*1200@60Hz HDMI2.0b:4096*2160@60Hz 24bpp DP1.4a:4096*2304@60Hz 36bpp eDP:4096*2304@60Hz 24bpp					

以太网 Ethernet	控制器 Controller	Intel®i225/i226-V
	速度 Speed	10M/100M/1000M/2.5Gbps
内部接口 Internal Connector	SATA	2 x SATA3.0(6Gbps)
	USB 3.0	4 x USB 3.0(10Gbps)
	USB 2.0	8 x USB2.0(480Mbps)
	音频 Audio	1 x HDA
	串口 COM	2 x COM
	GPIO	8-bits GPIO
	看门狗 Watch Dog	65536 Level, 0~65535 sec
	其他 Others	1、1 x LPC 2、1 x SMBUS 3、2 x SER 4、Smart Fan 2 Ports 5、1 x Power Button 6、1 x Reset
	拓展 Connector	2 x COM-E 220Pin 连接器
电源 Power Requirements	电源类型 Power Type	ATX: 12V,5VSB AT: 12V
	电源电压 Power input Voltage	Vin: 8.5V~20V(±5%) VSB: 5±5% RTC Battery: 2.0V~3.3V
	连接器 Connector type	底板供电
环境 Environment	工作温度 Operating Temperature	0~60°C
	存储温度 Storage Temperature	-40~85°C
	工作湿度 Operating Humidity	40°C@90% Relative Humidity, Non-condensing
	存储湿度 Storage Humidity	60°C@95% Relative Humidity, Non-condensing
物理特性 Physical	尺寸 Dimensions	95*95mm
	PCB 颜色 Color	Green

操作系统 OS	Microsoft	Support
	Linux	Support

1.2 驱动

Windows 10: https://pan.baidu.com/s/1ppIKmWgrAkhJ4_o_ChbNSQ?pwd=x2od

1.3 功能框图

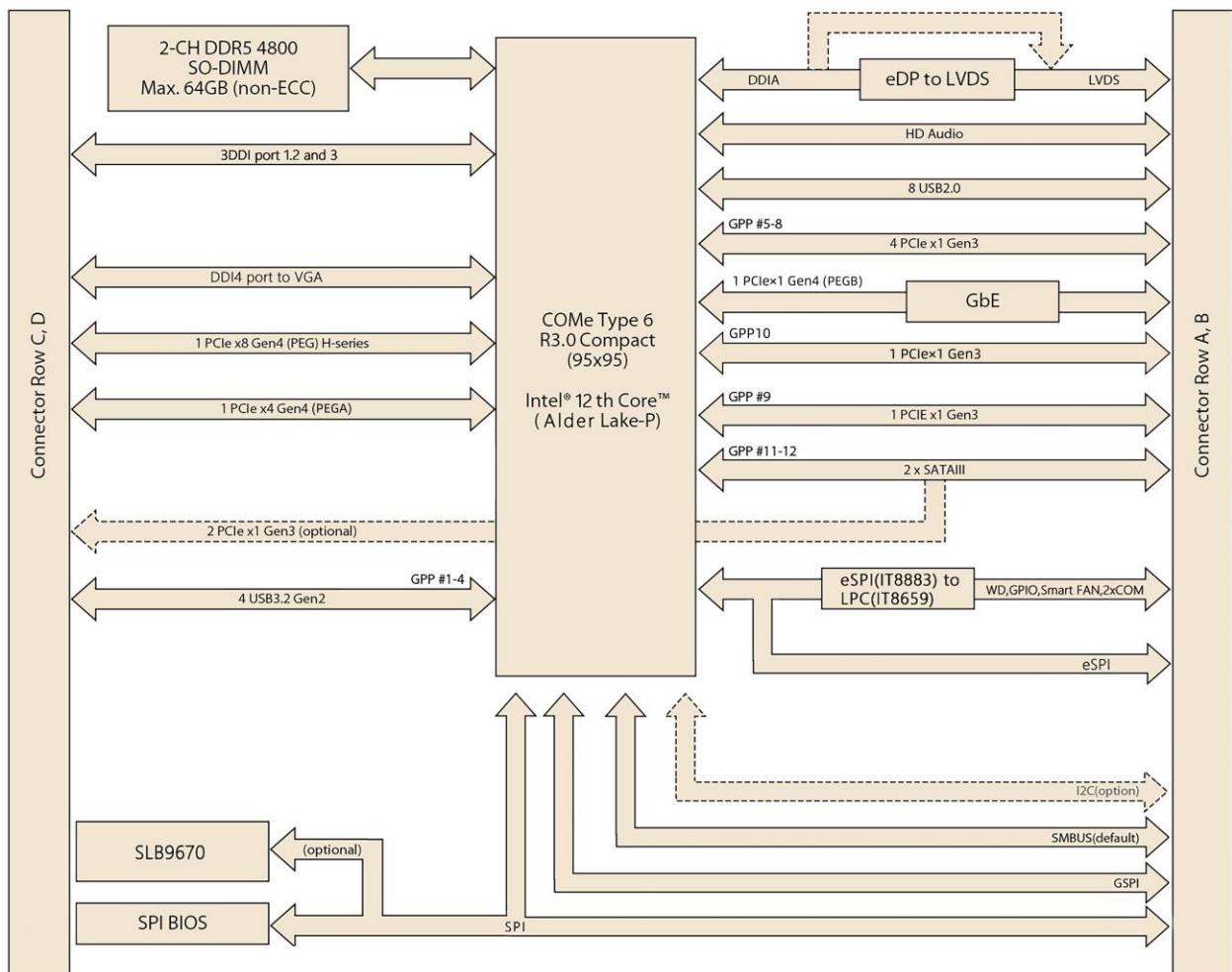

1.4 产品料号

Model	Part Number	Specification
ECM-C132	8.ZRT.80-1641-07-LEF	ECM-C132,VER 01,COME 核心板,12 代 ader-lake-P,i5-1350P,SRMJ5,DDR5 SODIMM+IT8659+IT8883,EDP,工包二十入
	8.ZRT.80-1641-01-LEF	ECM-C132,VER 01,COME 核心板,12 代 ader-lake-U,i3-1315u,SRMLW,DDR5 SODIMM+IT8659+IT8883,LVDS,工包二十入
	8.ZRT.80-1641-04-LEF	ECM-C132,VER 01,COME 核心板,12 代 ader-lake-U,i3-1315u,SRMLW,DDR5 SODIMM+IT8659+IT8883,EDP,工包二十入
	8.ZRT.80-1641-02-LEF	ECM-C132,VER 01,COME 核心板,12 代 ader-lake-U,i3-1215U,SRLFU,DDR5 SODIMM+IT8659+IT8883,LVDS,工包二十入
	8.ZRT.80-1641-05-LEF	ECM-C132,VER 01,COME 核心板,12 代 ader-lake-U,i3-1215U,SRLFU,DDR5 SODIMM+IT8659+IT8883,EDP,工包二十入
	8.ZRT.80-1641-03-LEF	ECM-C132,VER 01,COME 核心板,12 代 ader-lake-U,7305E,SRLZL,DDR5 SODIMM+IT8659+IT8883,LVDS,工包二十入
	8.ZRT.80-1641-06-LEF	ECM-C132,VER 01,COME 核心板,12 代 ader-lake-U,7305E,SRLZL,DDR5 SODIMM+IT8659+IT8883,EDP,工包二十入

1.5 产品照片

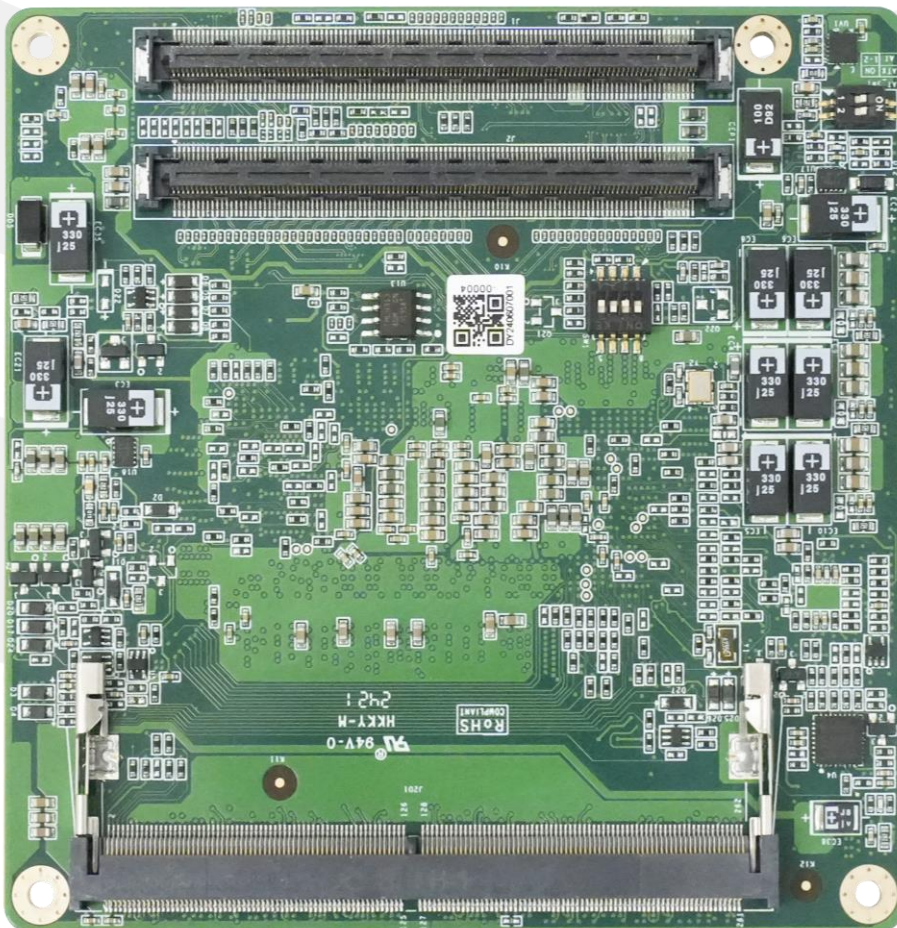

1.6 散热器

Part Number: 1.ZRT.48-6380-00-A00

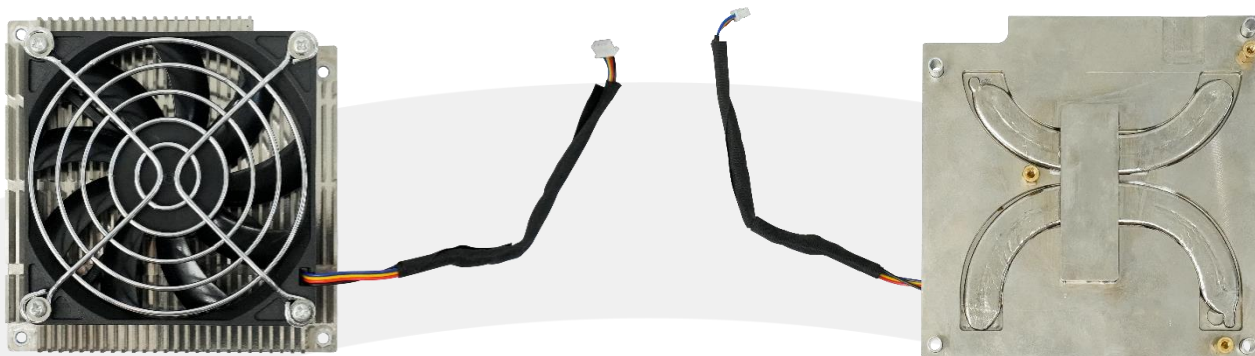

Part Number: 1.ZRT.48-6382-00-A00

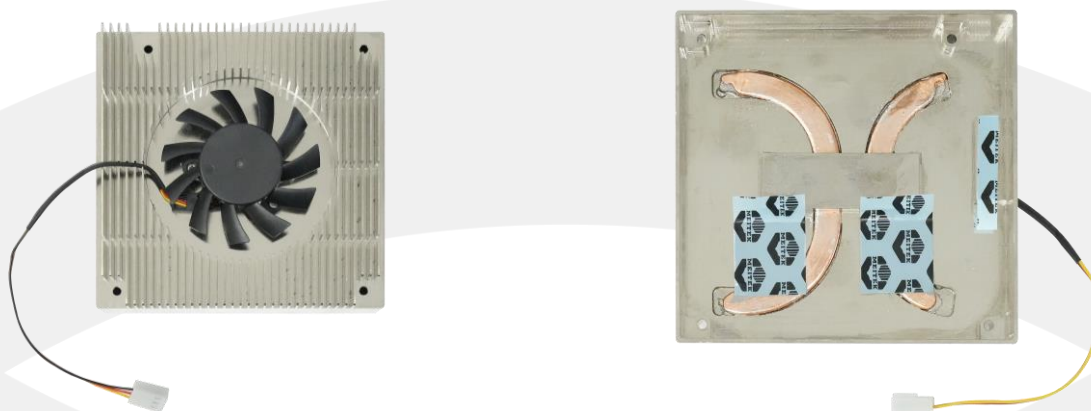

第二章 安装说明

2.1 尺寸图与安装流程

安装设备时, 请对照此示意图并仔细阅读下面的说明, 安装组件过程中必须小心, 对于有些部件, 如果安装不正确, 设备将不能正常工作。

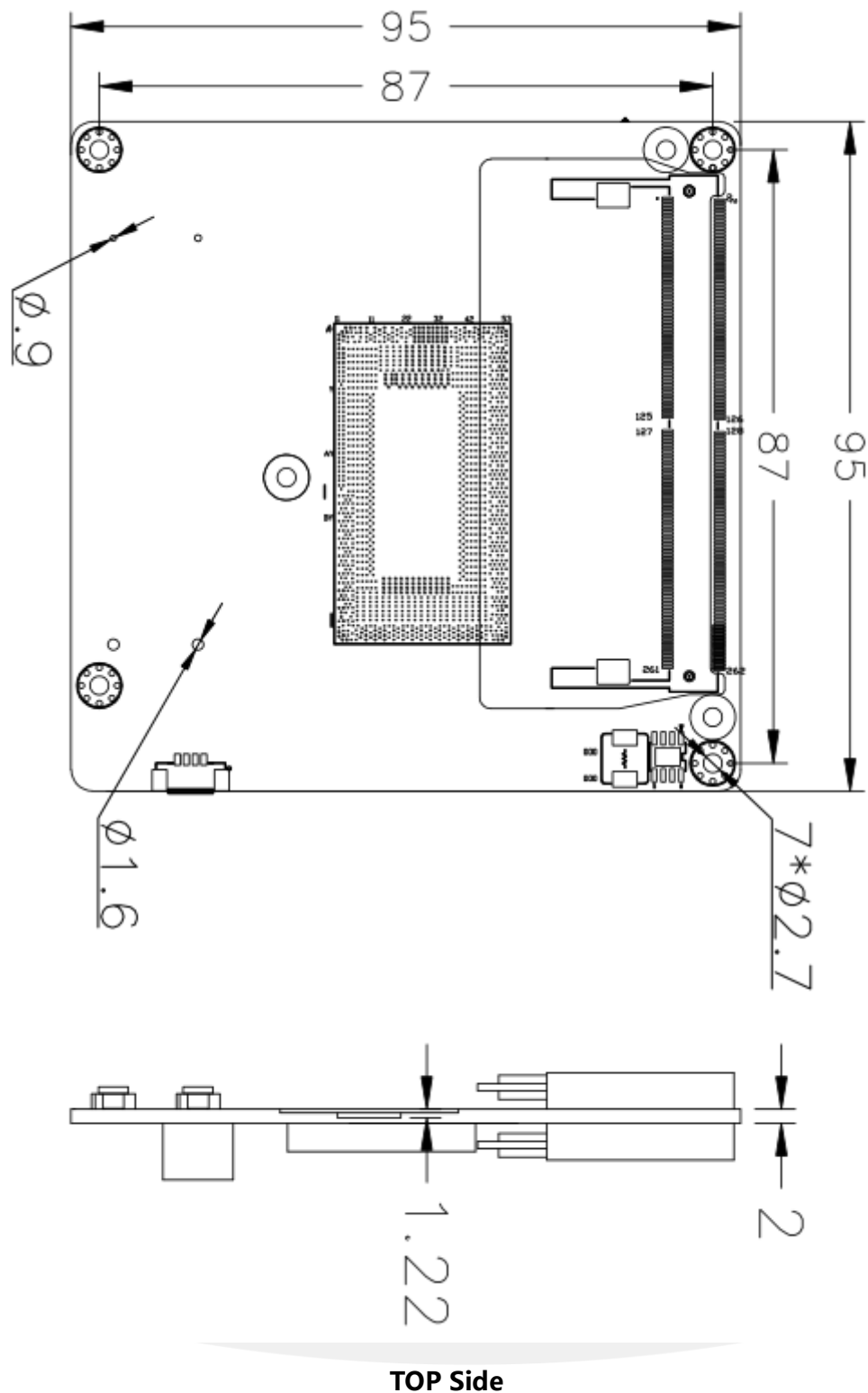

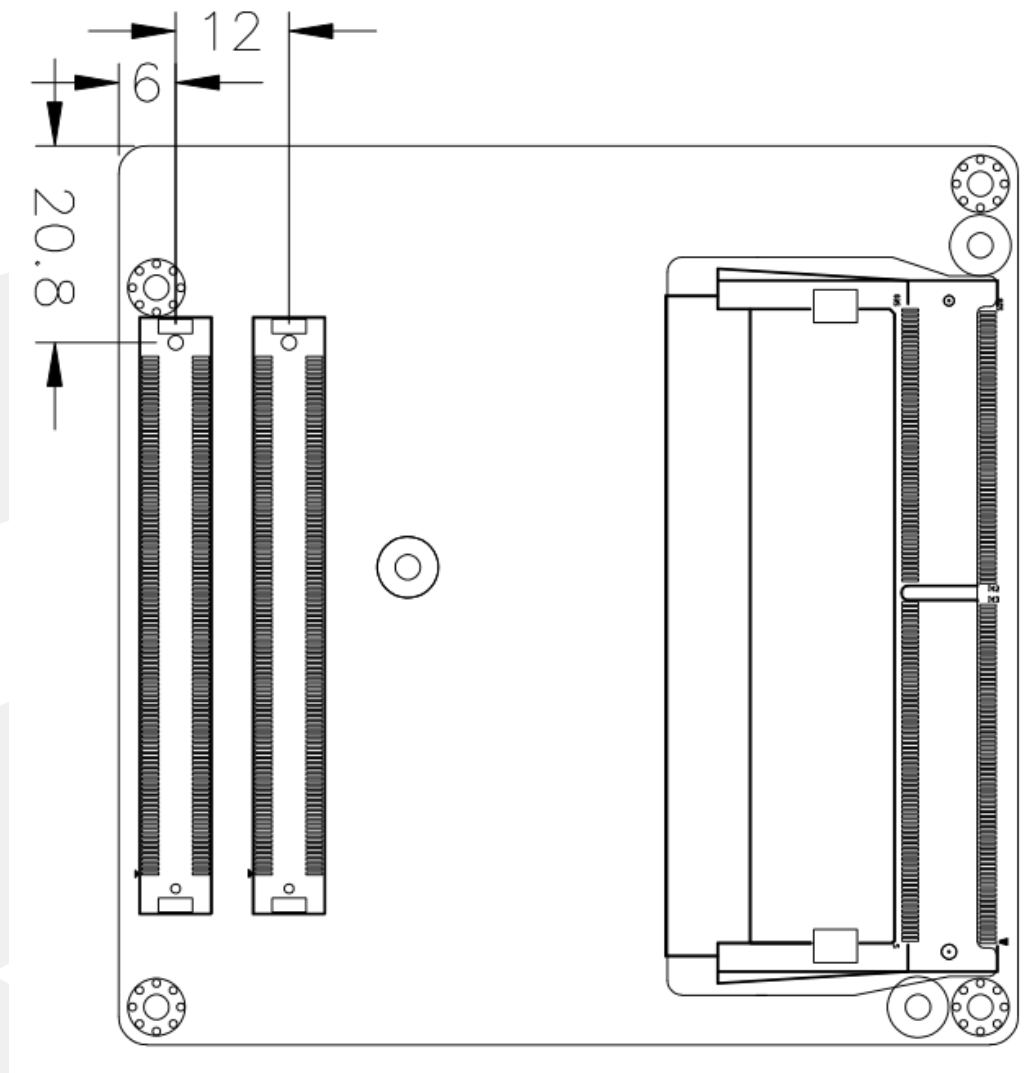

Bottom Side

1.使用配件的4颗盘头螺丝（垫片）将风扇和风扇护罩锁于散热器。

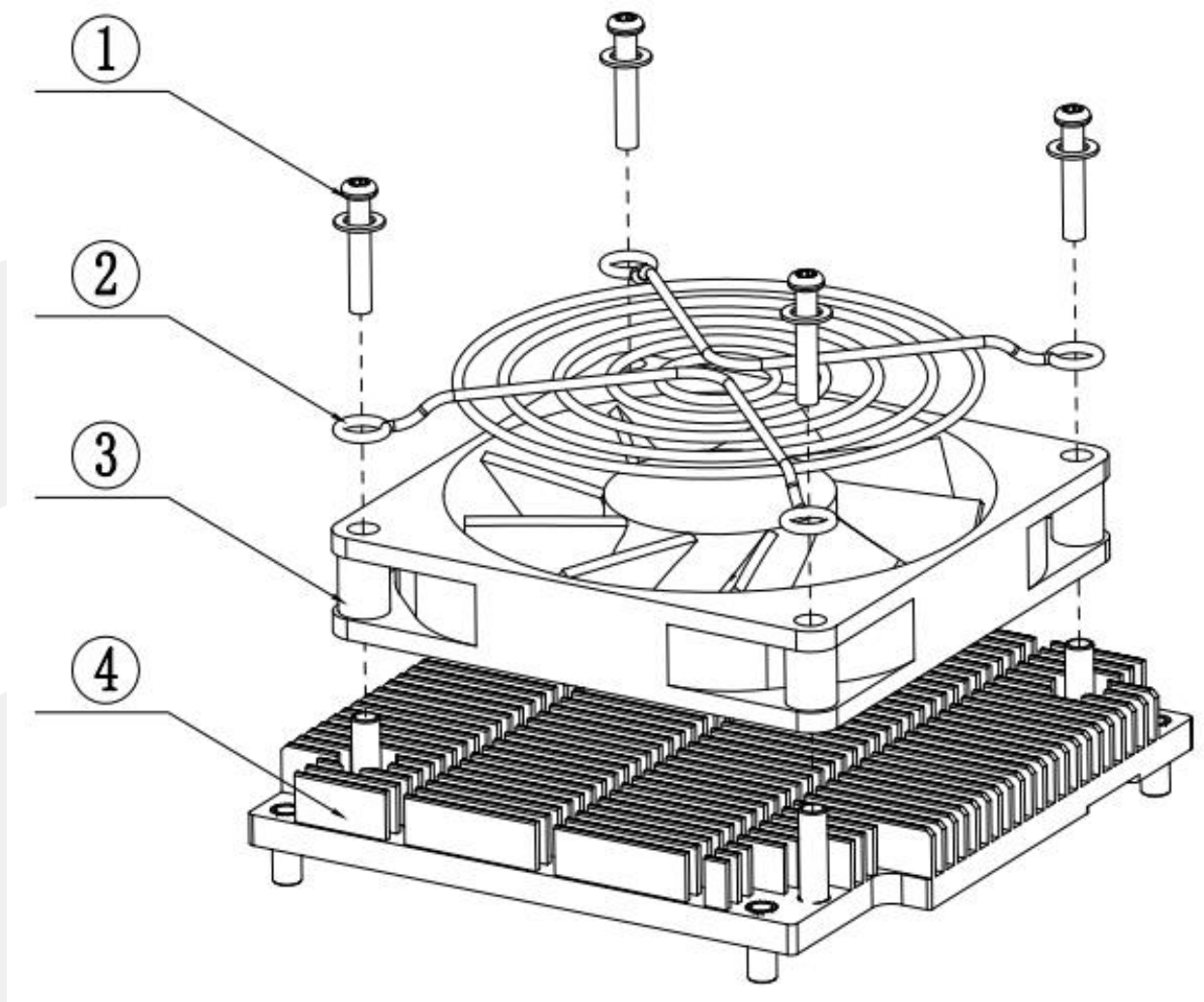

1)盘头螺丝+平垫 2)风扇护罩 3)风扇 4)散热器

2.安装底板螺柱后将核心板装于底板，再用4颗螺丝锁上散热器即可。

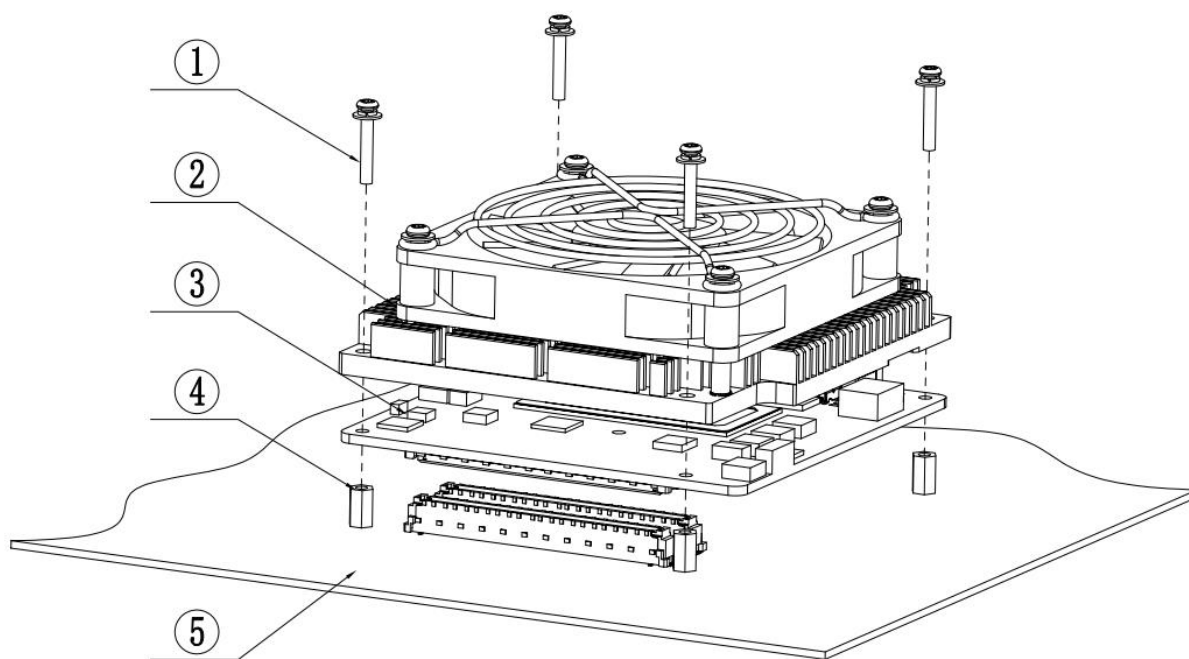

1)盘头螺丝+平弹垫 2)散热器 3)核心板 4)螺柱 5)底板

2.2 硬件安装

⚠ 注意：操作时，请戴上防静电手套，因为静电有可能会损坏部件。

本主板关键元器件都是集成电路，而这些元件很容易因为遭受静电的影响而损坏。因此，请在正式安装主板之前，请先做好以下的准备：

1. 拿主板时手握板边，尽可能不触及元器件和插头插座的引脚。
2. 接触集成路元件（如 CPU、RAM 等）时，最好戴上防静电手环/手套。
3. 在集成电路元件未安装前，需将元件放在防静电垫或防静电袋内。
4. 在确认电源的开关处于断开位置后，再插上电源插头。

2.3 跳线功能设置

在进行硬件设备安装之前请按照您的需要对相应的跳线进行设置。

提示：如何识别跳线、接口的第 1 针脚，观察插头插座旁边的文字标记，会用“1”或加粗的线条或三角符号表示；看看背面的焊盘，方型焊盘为第 1 针脚；所有跳线的针脚 1 旁都有 1 个白色箭头。

2.4 接口引脚定义

2.4.1 CPU_FAN1 引脚定义

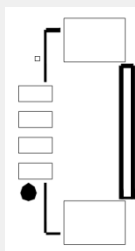

管脚	信号名称
1	GND
2	5V
3	FAN_TAC
4	FAN_CTL

2.4.2 SW1 引脚设定 (IT8659 Power-On Strapping)

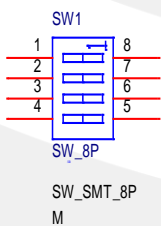

管脚	电平设定
1	拨码到 1VCC
2	拨码到 2(GND)
3	拨码到 3(VCC)
4	拨码到 4(GND)

2.4.3 AT_SW1 引脚设定 (ATX/AT 模式设定)

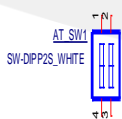

ATX 模式电平设定	AT 模式电平设定
拨码到 ON	拨码到 1-2

2.4.4 COM-E 220PIN 引脚定义

Pin	Signal Name	Pin	Signal Name	Pin	Signal Name	Pin	Signal Name
A1	GBE0_MDI3-	B1	GND (FIXED)	C1	GND (FIXED)	D1	GND (FIXED)
A2	GBE0_MDI3+	B2	GBE0_ACT#	C2	GND	D2	GND
A3	GBE0_LINK100#	B3	LPC_FRAME#	C3	USB_SSRX0-	D3	USB_SSTX0-
A4	GBE0_LINK1000#	B4	LPC_AD0	C4	USB_SSRX0+	D4	USB_SSTX0+
A5	GBE0_MDI2-	B5	LPC_AD1	C5	GND	D5	GND
A6	GBE0_MDI2+	B6	LPC_AD2	C6	USB_SSRX1-	D6	USB_SSTX1-
A7	GBE0_LINK#	B7	LPC_AD3	C7	USB_SSRX1+	D7	USB_SSTX1+
A8	GBE0_MDI1-	B8	ESPI_ALERT(option)	C8	GND	D8	GND
A9	GBE0_MDI1+	B9	N/A	C9	USB_SSRX2-	D9	USB_SSTX2-
A10	GND (FIXED)	B10	LPC_CLK	C10	USB_SSRX2+	D10	USB_SSTX2+
A11	GBE0_MDI0-	B11	GND (FIXED)	C11	GND (FIXED)	D11	GND (FIXED)
A12	GBE0_MDI0+	B12	PWRBTN#	C12	USB_SSRX3-	D12	USB_SSTX3-
A13	N/A	B13	SMB_CK	C13	USB_SSRX3+	D13	USB_SSTX3+
A14	SUS_S3#	B14	SMB_DAT	C14	GND	D14	GND
A15	SATA0_TX+	B15	SMB_ALERT#	C15	NC	D15	DDI1_CTRLCLK_AUX+
A16	SATA0_TX-	B16	SATA1_TX+	C16	NC	D16	DDI1_CTRLDATA_AUX-
A17	SUS_S4#	B17	SATA1_TX-	C17	SML0ALERT#(option)	D17	NC
A18	SATA0_RX+	B18	SUS_STAT#	C18	GND	D18	NC
A19	SATA0_RX-	B19	SATA1_RX+	C19	PCIE_RX6+	D19	PCIE_TX6+
A20	GND (FIXED)	B20	SATA1_RX-	C20	PCIE_RX6-	D20	PCIE_TX6-
A21	N/A	B21	GND (FIXED)	C21	GND (FIXED)	D21	GND (FIXED)
A22	N/A	B22	N/A	C22	PCIE_RX7+	D22	PCIE_TX7+
A23	SUS_S5#	B23	N/A	C23	PCIE_RX7-	D23	PCIE_TX7-
A24	N/A	B24	PWR_OK	C24	DDI1_HPD	D24	GND
A25	GBE0_MDI3-	B25	N/A	C25	SML0_CLK(option)	D25	GND
A26	N/A	B26	N/A	C26	SML0_DATA(option)	D26	DDI1_PAIR0+
A27	NC	B27	WDT	C27	SML1_CLK(option)	D27	DDI1_PAIR0-
A28	SATA_ACT#	B28	N/A	C28	SML1_DATA(option)	D28	GND
A29	HDA_SYNC	B29	AC/HDA_SDIN1	C29	NC	D29	DDI1_PAIR1+

Pin	Signal Name	Pin	Signal Name	Pin	Signal Name	Pin	Signal Name
A30	HDA_RST#	B30	AC/HDA_SDIN 0	C30	NC	D30	DDI1_PAIR1-
A31	GND (FIXED)	B31	GND (FIXED)	C31	GND (FIXED)	D31	GND (FIXED)
A32	HDA_BITCLK	B32	SPKR	C32	DDI2_CTRLCLK _AUX+	D32	DDI1_PAIR2+
A33	HDA_SDOOUT	B33	I2C_CK	C33	DDI2_CTRLDA TA_AUX-	D33	DDI1_PAIR2-
A34	BIOS_DIS0#	B34	I2C_DAT	C34	DDI2_DDC_AU X_SEL	D34	DDI1_DDC_AU X_SEL
A35	THRMTRIP#	B35	THRM#	C35	USB4_2_LSTX	D35	NC
A36	USB6-	B36	USB7-	C36	DDI3_CTRLCLK _AUX+	D36	DDI1_PAIR3+
A37	USB6+	B37	USB7+	C37	DDI3_CTRLDA TA_AUX-	D37	DDI1_PAIR3-
A38	USB_6_7_OC#	B38	USB_4_5_OC#	C38	DDI3_DDC_AU X_SEL	D38	GND
A39	USB4-	B39	USB5-	C39	DDI3_PAIR0+	D39	DDI2_PAIR0+
A40	USB4+	B40	USB5+	C40	DDI3_PAIR0-	D40	DDI2_PAIR0-
A41	GND (FIXED)	B41	GND (FIXED)	C41	GND (FIXED)	D41	GND (FIXED)
A42	USB2-	B42	USB3-	C42	DDI3_PAIR1+	D42	DDI2_PAIR1+
A43	USB2+	B43	USB3+	C43	DDI3_PAIR1-	D43	DDI2_PAIR1-
A44	USB_2_3_OC#	B44	USB_0_1_OC#	C44	DDI3_HPD	D44	DDI2_HPD
A45	USB0-	B45	USB1-	C45	GP_SPI_CS#	D45	GND
A46	USB0+	B46	USB1+	C46	DDI3_PAIR2+	D46	DDI2_PAIR2+
A47	VCC_RTC	B47	NC	C47	DDI3_PAIR2-	D47	DDI2_PAIR2-
A48	RSMRST_OUT #	B48	NA	C48	RSVD	D48	GND
A49	EXCD0_CPPE#	B49	SYS_RESET#	C49	DDI3_PAIR3+	D49	DDI2_PAIR3+
A50	LPC_SERIRQ	B50	CB_RESET#	C50	DDI3_PAIR3-	D50	DDI2_PAIR3-
A51	GND (FIXED)	B51	GND (FIXED)	C51	GND (FIXED)	D51	GND (FIXED)
A52	PCIE_TX5+	B52	PCIE_RX5+	C52	PEG10_RX0+	D52	PEG10_TX0+
A53	PCIE_TX5-	B53	PCIE_RX5-	C53	PEG10_RX0-	D53	PEG10_TX0-
A54	GPI0	B54	GPO1	C54	N/A	D54	NC
A55	PCIE_TX4+	B55	PCIE_RX4+	C55	PEG10_RX1+	D55	PEG10_TX1+
A56	PCIE_TX4-	B56	PCIE_RX4-	C56	PEG10_RX1-	D56	PEG10_TX1-
A57	GND	B57	GPO2	C57	N/A	D57	GND
A58	PCIE_TX3+	B58	PCIE_RX3+	C58	PEG10_RX2+	D58	PEG10_TX2+
A59	PCIE_TX3-	B59	PCIE_RX3-	C59	PEG10_RX2-	D59	PEG10_TX2-
A60	GND (FIXED)	B60	GND (FIXED)	C60	GND (FIXED)	D60	GND (FIXED)
A61	PCIE_TX2+	B61	PCIE_RX2+	C61	PEG10_RX3+	D61	PEG10_TX3+
A62	PCIE_TX2-	B62	PCIE_RX2-	C62	PEG10_RX3-	D62	PEG10_TX3-
A63	GPI1	B63	GPO3	C63	RSVD	D63	GND

Pin	Signal Name	Pin	Signal Name	Pin	Signal Name	Pin	Signal Name
A64	PCIE_TX1+	B64	PCIE_RX1+	C64	RSVD	D64	GND
A65	PCIE_TX1-	B65	PCIE_RX1-	C65	PEG10_RX4+	D65	PEG10_TX4+
A66	GND	B66	WAKE0#	C66	PEG10_RX4-	D66	PEG10_TX4-
A67	GPI2	B67	WAKE1#	C67	NC	D67	GND
A68	PCIE_TX0+	B68	PCIE_RX0+	C68	PEG10_RX5+	D68	PEG10_TX5+
A69	PCIE_TX0-	B69	PCIE_RX0-	C69	PEG10_RX5-	D69	PEG10_TX5-
A70	GND (FIXED)	B70	GND (FIXED)	C70	GND (FIXED)	D70	GND (FIXED)
A71	LVDS_A0+	B71	LVDS_B0+	C71	PEG10_RX6+	D71	PEG10_TX6+
A72	LVDS_A0-	B72	LVDS_B0-	C72	PEG10_RX6-	D72	PEG10_TX6-
A73	LVDS_A1+	B73	LVDS_B1+	C73	GND	D73	GND
A74	LVDS_A1-	B74	LVDS_B1-	C74	PEG10_RX7+	D74	PEG10_TX7+
A75	LVDS_A2+	B75	LVDS_B2+	C75	PEG10_RX7-	D75	PEG10_TX7-
A76	LVDS_A2-	B76	LVDS_B2-	C76	GND	D76	GND
A77	LVDS_VDD_EN	B77	LVDS_B3+	C77	GND	D77	GND
A78	LVDS_A3+	B78	LVDS_B3-	C78	PEG60_RX0+	D78	PEG60_TX0+
A79	LVDS_A3-	B79	LVDS_BKLT_EN	C79	PEG60_RX0-	D79	PEG60_TX0-
A80	GND (FIXED)	B80	GND (FIXED)	C80	GND (FIXED)	D80	GND (FIXED)
A81	LVDS_A_CK+	B81	LVDS_B_CK+	C81	PEG60_RX1+	D81	PEG60_TX1+
A82	LVDS_A_CK-	B82	LVDS_B_CK-	C82	PEG60_RX1-	D82	PEG60_TX1-
A83	LVDS_I2C_CK	B83	LVDS_BKLT_CTRL	C83	GND	D83	GND
A84	LVDS_I2C_DAT	B84	VCC_5V_SBY	C84	GND	D84	GND
A85	GPI3	B85	VCC_5V_SBY	C85	PEG60_RX2+	D85	PEG60_TX2+
A86	GP_SPI_MOSI	B86	VCC_5V_SBY	C86	PEG60_RX2-	D86	PEG60_TX2-
A87	eDP_HPD (option)	B87	VCC_5V_SBY	C87	GND	D87	GND
A88	PCIE_CLK_REF+	B88	BIOS_DIS1#	C88	PEG60_RX3+	D88	PEG60_TX3+
A89	PCIE_CLK_REF-	B89	N/A	C89	PEG60_RX3-	D89	PEG60_TX3-
A90	GND (FIXED)	B90	GND (FIXED)	C90	GND (FIXED)	D90	GND (FIXED)
A91	SPI_POWER	B91	VGA_GRN	C91	PEG62_RX0+	D91	PEG62_TX0+
A92	SPI_MISO	B92	VGA_BLU	C92	PEG62_RX0-	D92	PEG62_TX0-
A93	GPO0	B93	VGA_HSYNC	C93	GND	D93	GND
A94	SPI_CLK	B94	VGA_VSYNC	C94	PEG62_RX1+	D94	PEG62_TX1+
A95	SPI_MOSI	B95	VGA_I2C_CK	C95	PEG62_RX1-	D95	PEG62_TX1-
A96	TPM_PP	B96	VGA_I2C_DAT	C96	GND	D96	GND
A97	N/C	B97	SPI_CS#	C97	GND	D97	GND
A98	SER0_TX	B98	GP_SPI_MISO	C98	PEG62_RX2+	D98	PEG62_TX2+
A99	SER0_RX	B99	GP_SPI_CK	C99	PEG62_RX2-	D99	PEG62_TX2-
A100	GND (FIXED)	B100	GND (FIXED)	C100	GND (FIXED)	D100	GND (FIXED)

Pin	Signal Name	Pin	Signal Name	Pin	Signal Name	Pin	Signal Name
A101	SER1_TX	B101	FAN_PWMOUT	C101	PEG62_RX3+	D101	PEG62_TX3+
A102	SER1_RX	B102	FAN_TACHIN	C102	PEG62_RX3-	D102	PEG62_TX3-
A103	NC	B103	NC	C103	GND	D103	GND
A104	VCC_12V	B104	VCC_12V	C104	VCC_12V	D104	VCC_12V
A105	VCC_12V	B105	VCC_12V	C105	VCC_12V	D105	VCC_12V
A106	VCC_12V	B106	VCC_12V	C106	VCC_12V	D106	VCC_12V
A107	VCC_12V	B107	VCC_12V	C107	VCC_12V	D107	VCC_12V
A108	VCC_12V	B108	VCC_12V	C108	VCC_12V	D108	VCC_12V
A109	VCC_12V	B109	VCC_12V	C109	VCC_12V	D109	VCC_12V
A110	GND	B110	GND (FIXED)	C110	GND (FIXED)	D110	GND (FIXED)

第三章 BIOS 程序设置

AMI BIOS 刷新

BIOS 提供对硬件资源的底层驱动，是联系硬件和操作系统的桥梁。现在硬件和各种应用软件不断更新，当您的系统遇到问题时，例如系统不支持最新公布的 CPU 时，就需要升级您的 BIOS 了。

注意：

1. **升级 BIOS 只在遇到问题，必要的时候进行。**
2. **升级 BIOS 请使用我们驱动光盘内所附的 BIOS 读写程序，或者在相关网站下载更新版本的程序。**
3. **在升级过程中不要关闭电源或重新启动系统，防止您的 BIOS 资料被损坏，系统也可能不能启动。**
4. **为防止意外发生，请您先备份当前的 BIOS 资料。**

AMI BIOS 描述

开机时，BIOS 会对主板上的硬件进行自我诊断，设定硬件时序参数等工作，最后才将系统控制权交给操作系统。如何正确的设定 BIOS 参数对系统是否稳定的工作及系统是否工作在最佳状态至关重要。

进入 BIOS 参数设置

电脑开机，在完成自我诊断后，屏幕上会显示出如下信息：Del->SETUP，此时您点击一下 Del 键，则 BIOS 在完成 IDE 等设备的侦测后会自动转入 SETUP 设置画面。

1. 打开系统电源或重新启动系统，显示器屏幕将出现自我测试的信息。
2. 当屏幕中间出现“Pressto enter setup”提示时，按下键，就可以进入 BIOS 设定程序。
3. 以方向键移动至您要修改的选项，按下<Enter>键即可进入该选项的子画面。
4. 使用方向键及<Enter>键即可修改所选项目的值，按回车键选择 BIOS 选项并修改。
5. 任何时候按下<Esc>键即可回到上一画面。



提示：BIOS 参数属于系统关键信息，请勿随意设置，如需设置或者升级请联系我司售后支持，谢谢！

3.1 Main Screen

The Main screen is the first screen that is displayed when the BIOS Setup is entered.

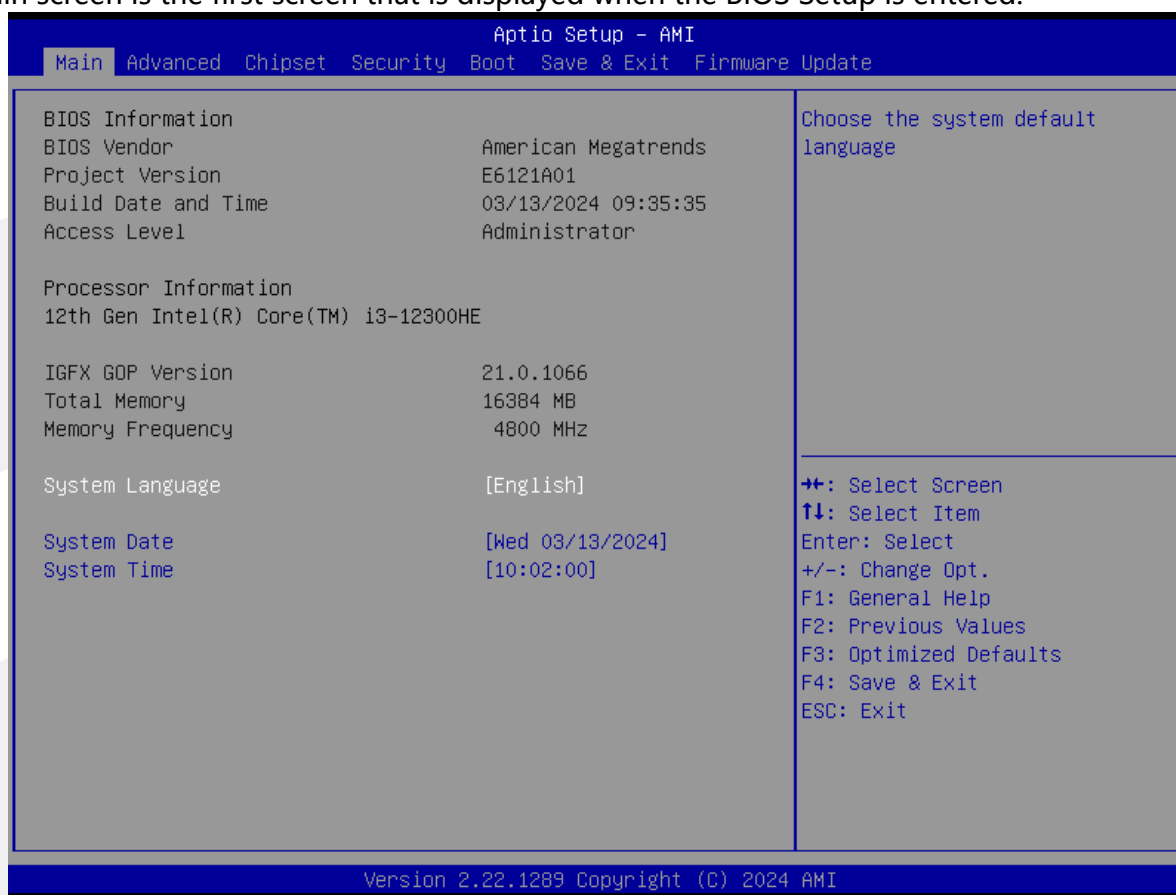

Setup Item	Options	Help Text	Comments
BIOS Information			
BIOS Vendor			Displays BIOS vendor.
Project Version			Displays the current BIOS version: Format: AAAABBC AAAAA = Project name BB = BIOS revision C = Customer number
Build Date and Time			Displays the current BIOS build date.
Access Level			Displays password level that setup is running in: Administrator or User. With no passwords set, Administrator is the default mode.
Process Information			
CPU XXXXX			Displays the CPU BrandString installed in the system.
Memory Information			
Total Memory			Displays the total physical memory installed in the system, MB Unit.
Memory Frequency			

Setup Item	Options	Help Text	Comments
System Language	English	Choose the system default language.	
System Date	[Day of week MM/DD/YYYY]	Set and display the Date..	
System Time	[HH:MM:SS]	Set and display the Time.	

3.2 Advanced Screen

The Advanced screen provides an access point to configure several options. On this screen, the user selects the option that is to be configured.

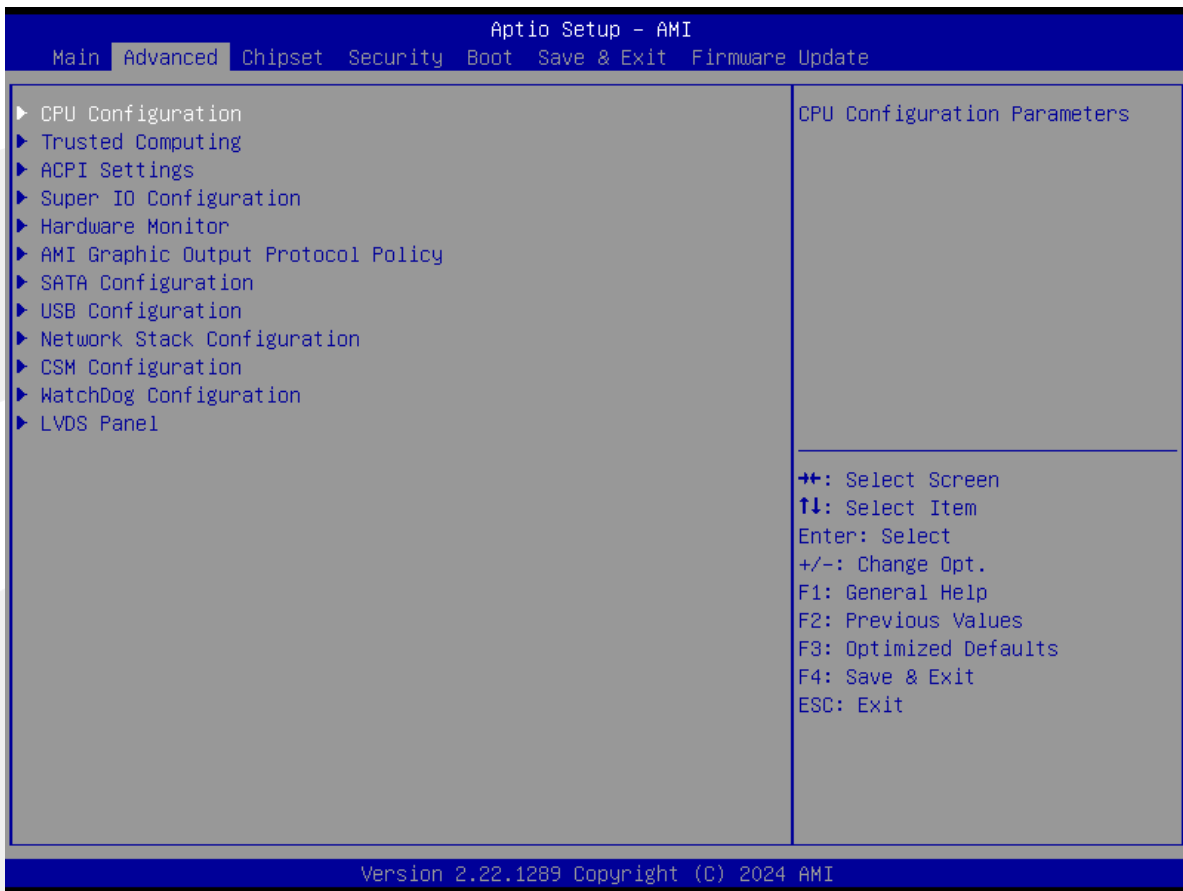

Setup Item	Options	Help Text	Comments
CPU Configuration		CPU Configuration Parameters.	
Trusted Computing		Trusted Computing Settings	
ACPI Settings		System ACPI Parameters.	
Super IO Configuration		System Super IO chip Parameters.	
Hardware Monitor		Monitor hardware states.	
AMI Graphic Output Protocol Policy			
SATA Configuration		SATA Devices Configuration.	
USB Configuration		USB Configuration Parameters.	
Network Stack configuration		Enable/Disable UEFI Network Stack.	
CSM Configuration		CSM configuration: Enable/Disable, Option ROM execution settings, etc.	
Watchdog configuration		Set System Watchdog Parameters.	
LVDS Panel		LVDS Panel Settings.	

3.2.1 CPU Configuration Screen

The CPU Configuration screen allows the user to view the processor information, and to enable or disable processor options. To access this screen from the Main screen, choose **Advanced > CPU Configuration**.

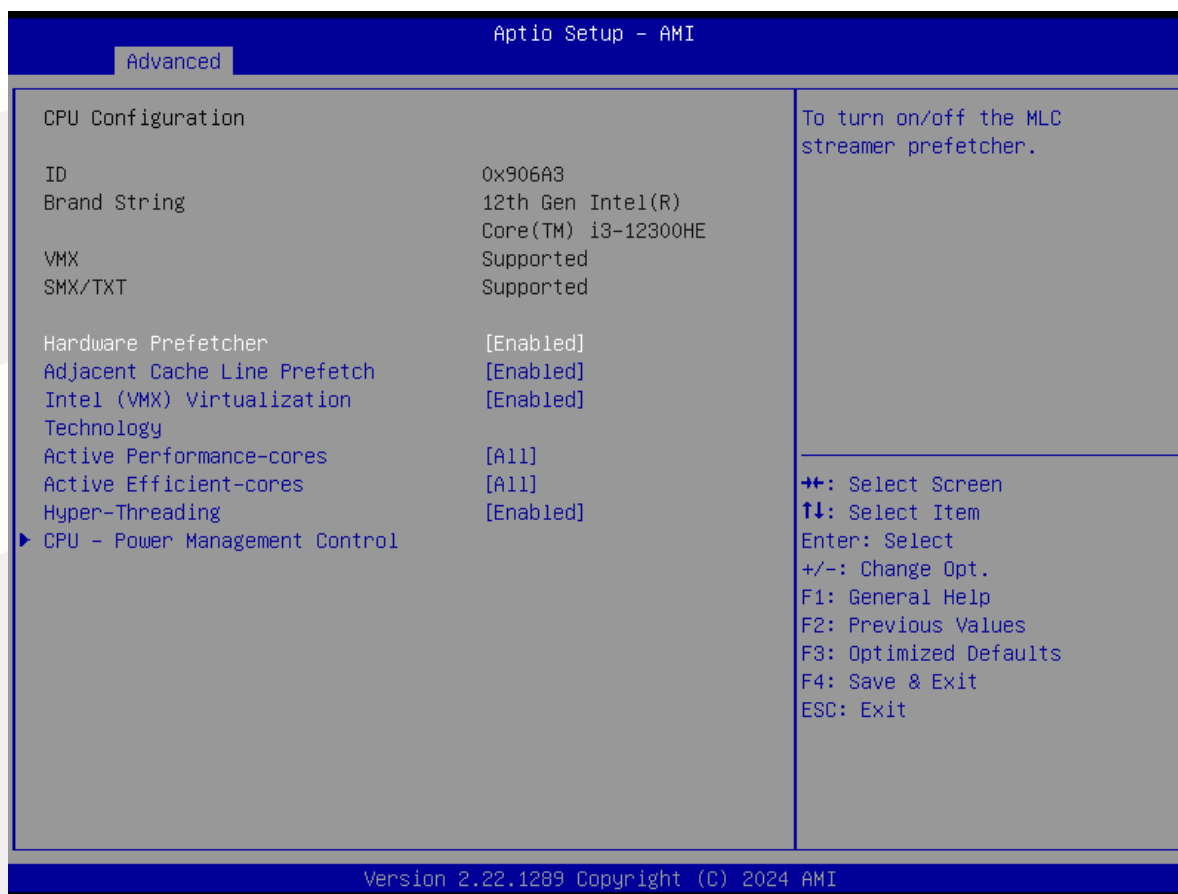

Aptio Setup - AMI

Advanced

CPU - Power Management Control		Select the performance state that the BIOS will set starting from reset vector.
Boot performance mode	[Turbo Performance]	
Intel(R) SpeedStep(tm)	[Enabled]	++: Select Screen ↑↓: Select Item Enter: Select +/-: Change Opt. F1: General Help F2: Previous Values F3: Optimized Defaults F4: Save & Exit ESC: Exit
Turbo Mode	[Enabled]	
▶ Config TDP Configurations		
C states	[Disabled]	
Tcc Activation Offset	15	
Version 2.22.1289 Copyright (C) 2024 AMI		

Aptio Setup - AMI

Advanced

Config TDP Configurations		▲ Applies Configurable Processor Base Power (cTDP) initialization settings based on non-cTDP or cTDP. Default is 1: Applies to cTDP; if 0 then applies non-cTDP and BIOS will bypass cTDP initialization flow
Enable Configurable TDP	[Applies to cTDP]	
Configurable TDP Boot Mode	[Nominal]	++: Select Screen ↑↓: Select Item Enter: Select +/-: Change Opt. F1: General Help F2: Previous Values F3: Optimized Defaults F4: Save & Exit ESC: Exit
Configurable TDP Lock	[Disabled]	
CTDP BIOS control	[Disabled]	
ConfigTDP Levels	3	
ConfigTDP Turbo Activation Ratio	18 (Unlocked)	
Power Limit 1	45.0W (MSR:45.0)	
Power Limit 2	45.0W (MSR:95.0)	
Custom Settings Nominal		
ConfigTDP Nominal	Ratio:19 TAR:18 PL1:13.0W	
Power Limit 1	0	
Power Limit 2	0	
Power Limit 1 Time Window	[0]	
ConfigTDP Turbo Activation Ratio	0	
Custom Settings Level1		
ConfigTDP Level1	Ratio:11 TAR:10 PL1:3.0W	
Power Limit 1	0	
Power Limit 2	0	
Power Limit 1 Time Window	[0]	
ConfigTDP Turbo Activation Ratio	0	
Version 2.22.1289 Copyright (C) 2024 AMI		

Setup Item	Options	Help Text	Comments
CPU Configuration			
VMX			
SMX/TXT			
Hardware Prefetcher	Enabled Disabled	To turn on/off the MLC streamer prefetcher.	
Adjacent Cache line Prefetch	Enabled Disabled	To turn on/off prefetching of adjacent cache lines.	
Intel(VMX) Technology	Enabled Disabled	When enabled, a VMM can utilize the additional hardware capabilities provided by vanderpool technology.	
Active Performance-cores	All 1 2 3	Number of P-cores to enable in each processor package.	
Active Efficient-cores	All 1 2	Number of E-cores to enable in each processor package.	
Hyper-Threading			
CPU - Power Management Control			
Boot performance mode	Max Non-Turbo Max battery Turbo Performance	Select the performance state that the BIOS will set starting from reset vector.	
Intel® speedStep™	Enabled Disabled	Allows more than two frequency ranges to be supported.	
Turbo Mode	Enabled		
Config TDP Configurations			
C States	Disabled		
Tcc Activation Offset			

3.2.2 Trusted Computing

The ACPI Settings screen allows the user to set the Trusted Computing(TPM) parameters. To access this screen from the Main screen, choose **Advanced > Trusted Computing**.



3.2.3 ACPI Settings Screen

The ACPI Settings screen allows the user to set the system ACPI parameters. To access this screen from the Main screen, choose **Advanced > ACPI Settings**.

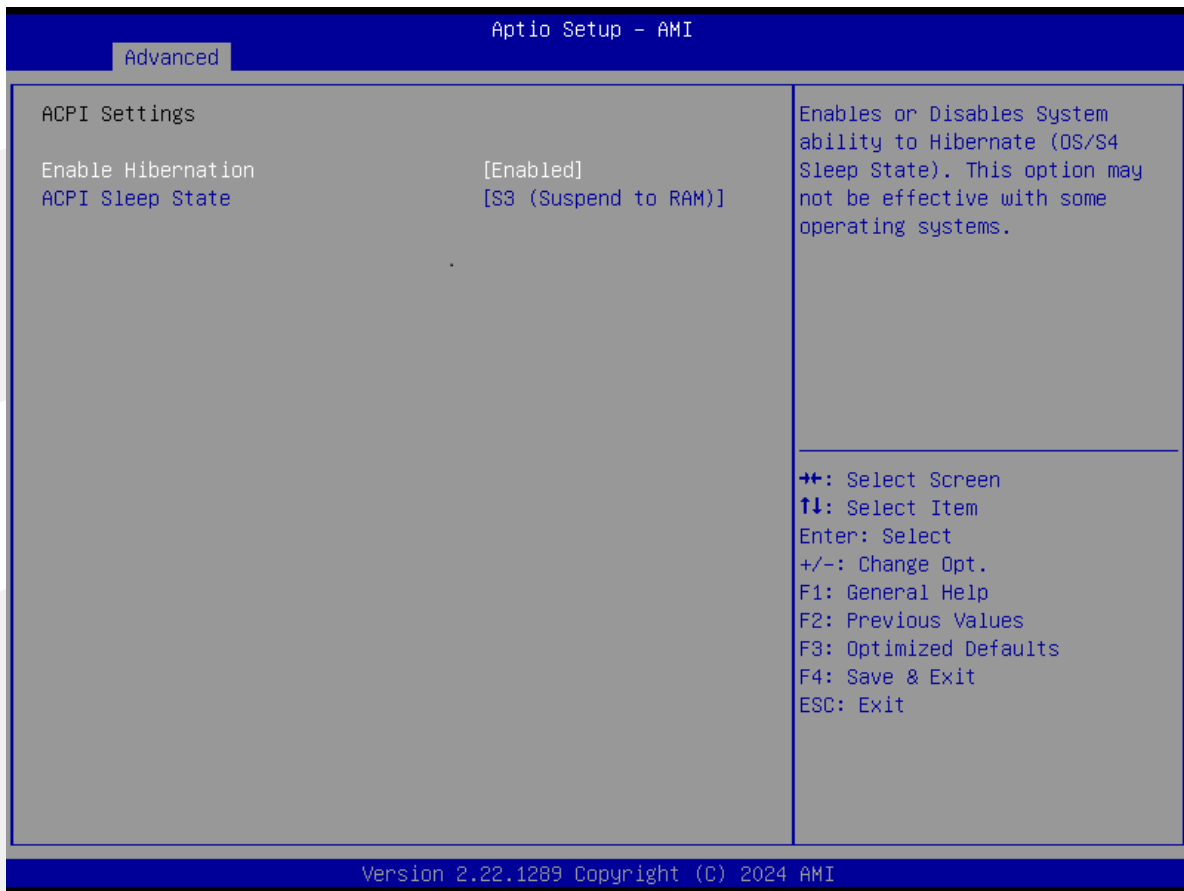

Setup Item	Options	Help Text	Comments
ACPI Settings			
Enable Hibernation	Enabled		
ACPI Sleep State	Suspend Disabled S3 (Suspend to RAM)	Select the highest ACPI sleep state the system will enter when the SUSPEND button is pressed.	Sleep supported optionally.

3.2.4 Super IO Configuration

The Super IO Configuration screen allows the user to view the super IO information, and to enable or disable super IO options. To access this screen from the Advanced screen, choose **Advanced > Super IO Configuration**.

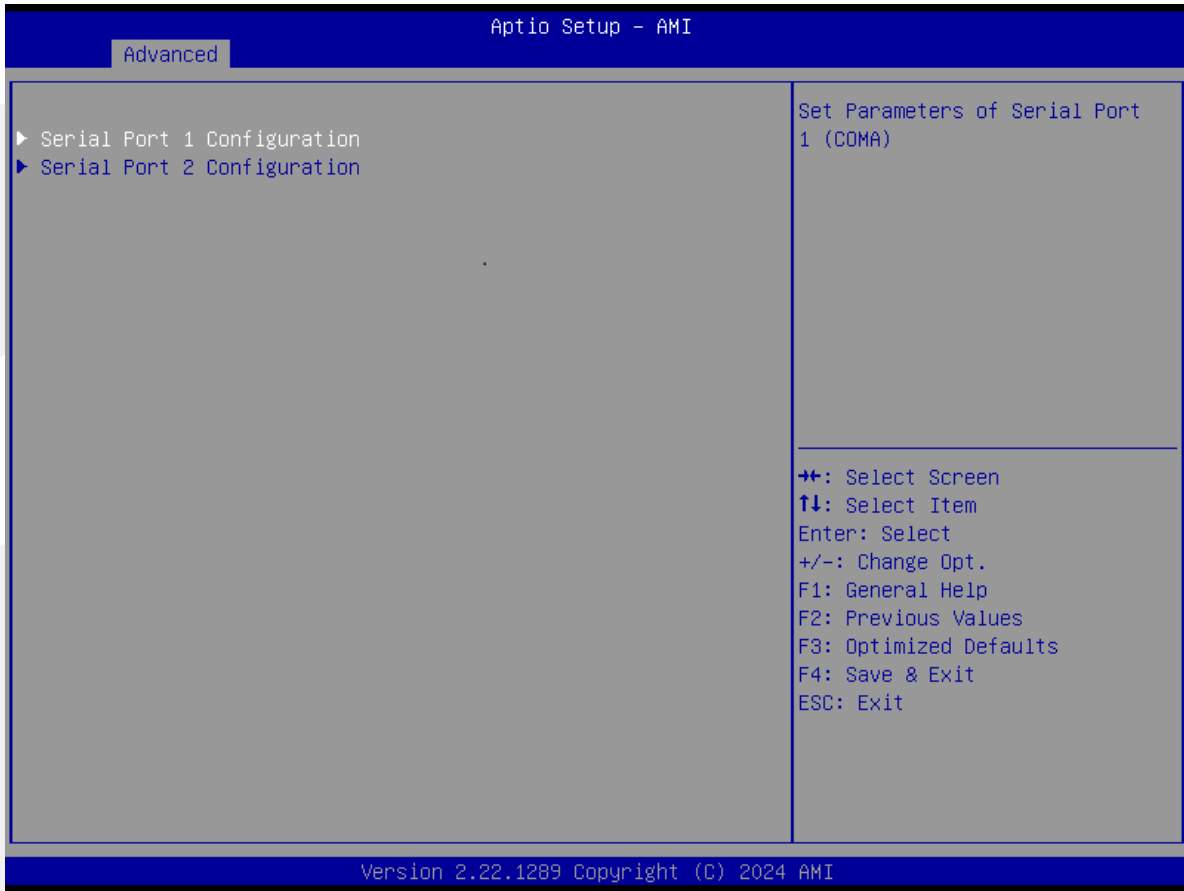

Setup Item	Options	Help Text	Comments
Super IO Configuration			
Serial Port 1 Configuration			Set Parameters of Serial Port 1 (COM1).
Serial Port 2 Configuration			Set Parameters of Serial Port 2 (COM2).

3.2.4.1 Serial PortX Configuration

The Super IO Configuration screen allows the user to view the super IO information, and to enable or disable serial port options. To access this screen from the Advanced screen, choose **Advanced-> Super IO Configuration->Serial PortX Configuration**.

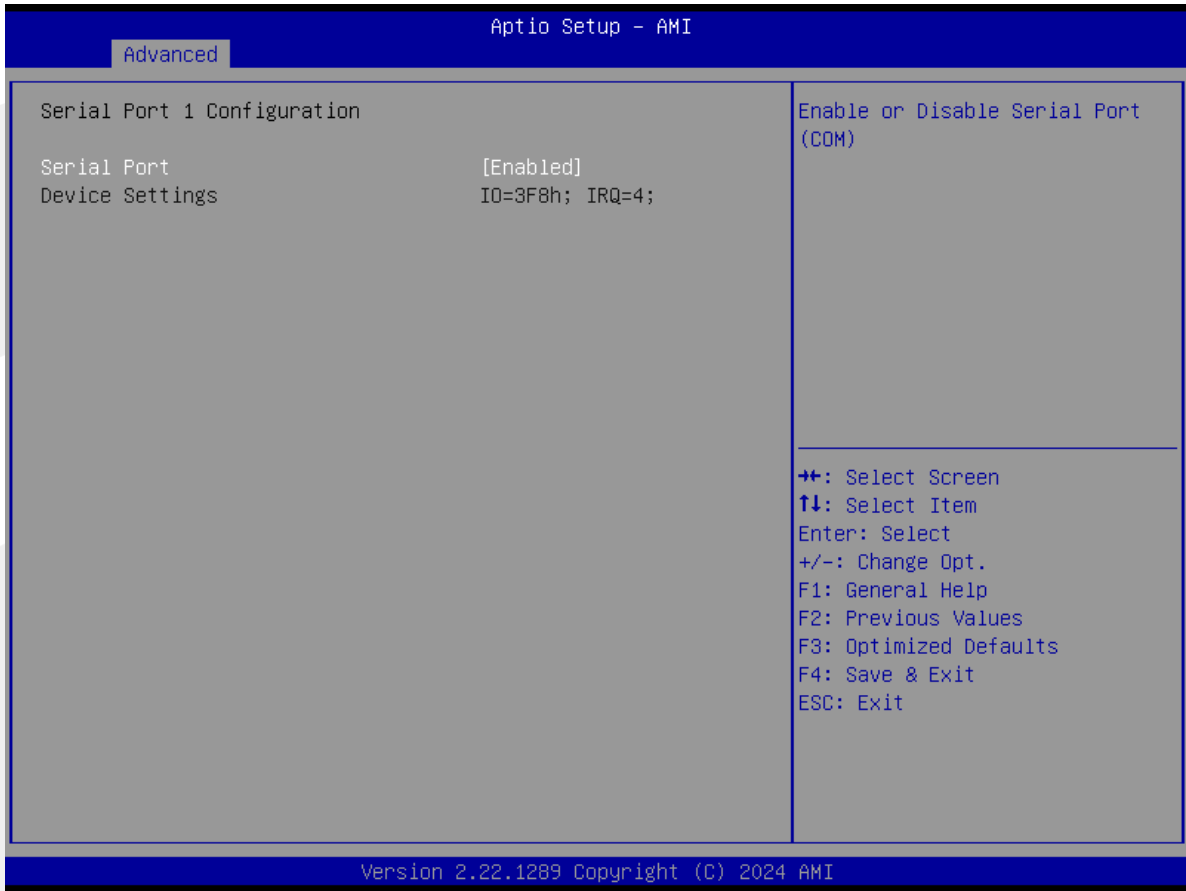

Setup Item	Options	Help Text	Comments
Serial PortX Configuration			
Serial Port	Enabled/Disabled	Enable or Disable Serial Port (COM).	

3.2.5 Hardware Monitor

The hardware monitor screen allows the user to view the hardware information. To access this screen from the Advanced screen, choose **Advanced-> Hardware Monitor**.

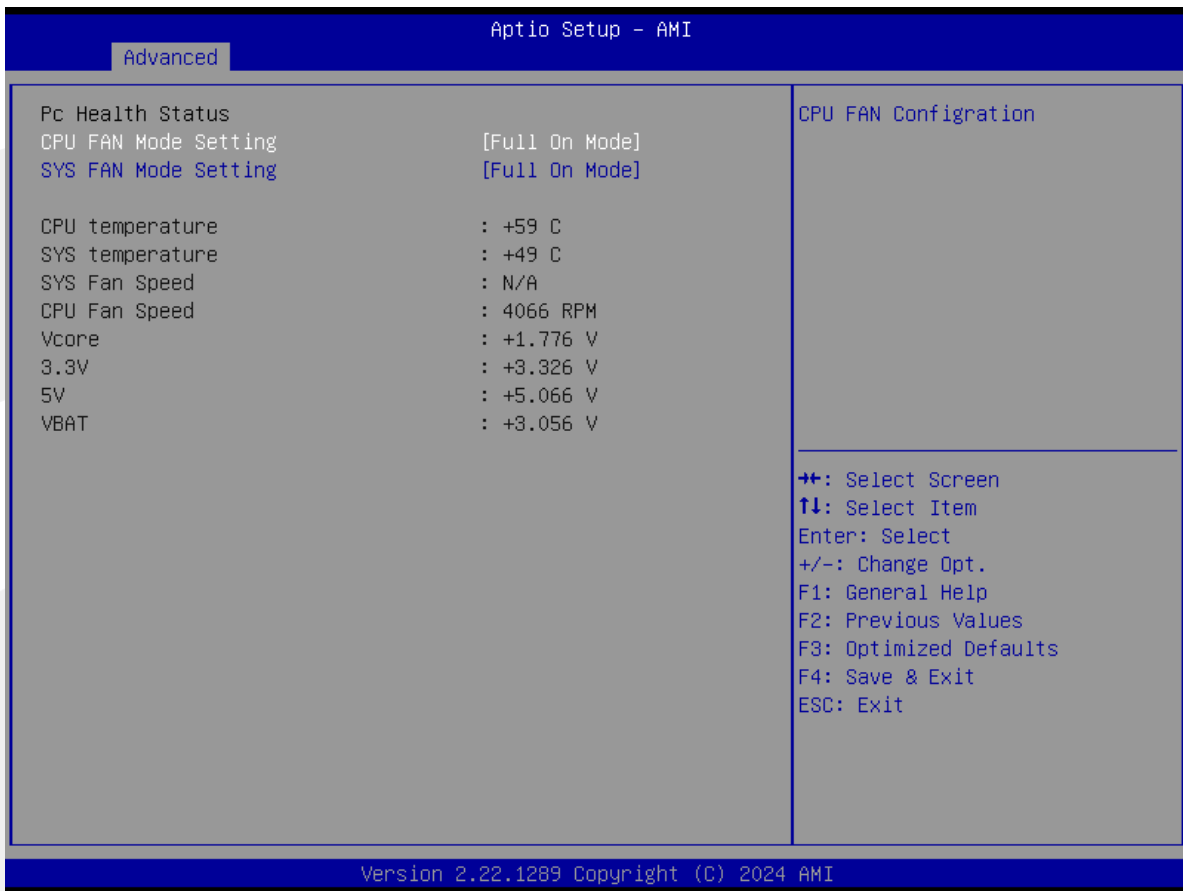

Setup Item	Options	Help Text	Comments
PC Health Status			
CPU FAN Mode Setting	Full On mode Automatic mode Manual mode	Fan control mode select.	When Manual mode selected, Manual PWM Setting shows to set FAN PWM Duty.
SYS FAN Mode Setting	Full On mode Automatic mode Manual mode	Fan control mode select.	When Manual mode selected, Manual PWM Setting shows to set FAN PWM Duty.
CPU temperature		Shows Current CPU temperature.	NOTE1: Sometimes not the actual temperature value, just indicates temperature tolerance limitation.
SYS temperature			
SYS Fan Speed			HW Information.
CPU Fan Speed			

3.2.6 SATA Configuration

The SATA Configuration screen allows the user to view the SATA Controller information, and to enable or disable SATA Controller options. To access this screen from the Main screen, choose **Advanced > SATA Configuration**.

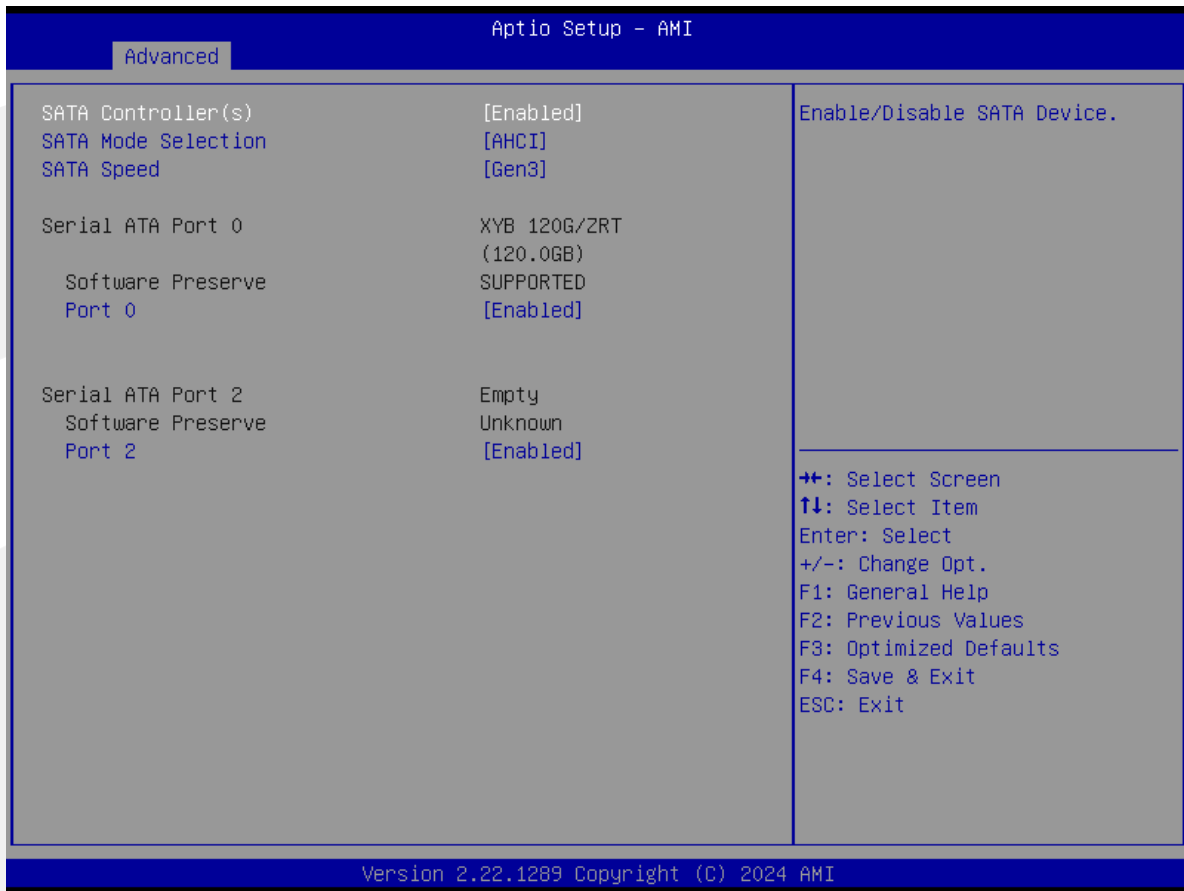

Setup Item	Options	Help Text	Comments
SATA Configuration			
SATA Configuration			
SATA Controller(s)	Enabled Disabled	Enable / Disable SATA Device.	
SATA Mode Selection	AHCI Mode	Select AHCI.	
SATA Speed			
Serial ATA Port 0			Show HDD information connected.
Serial ATA Port 1			
Serial ATA Port 2			

Note: If SATA or PCIE RAID groups are configured separately, contact technical support.

3.2.7 USB Configuration

The USB Configuration screen allows the user to view the USB Configuration information, and to enable or disable options. To access this screen from the Main screen, choose **Advanced > USB Configuration**.

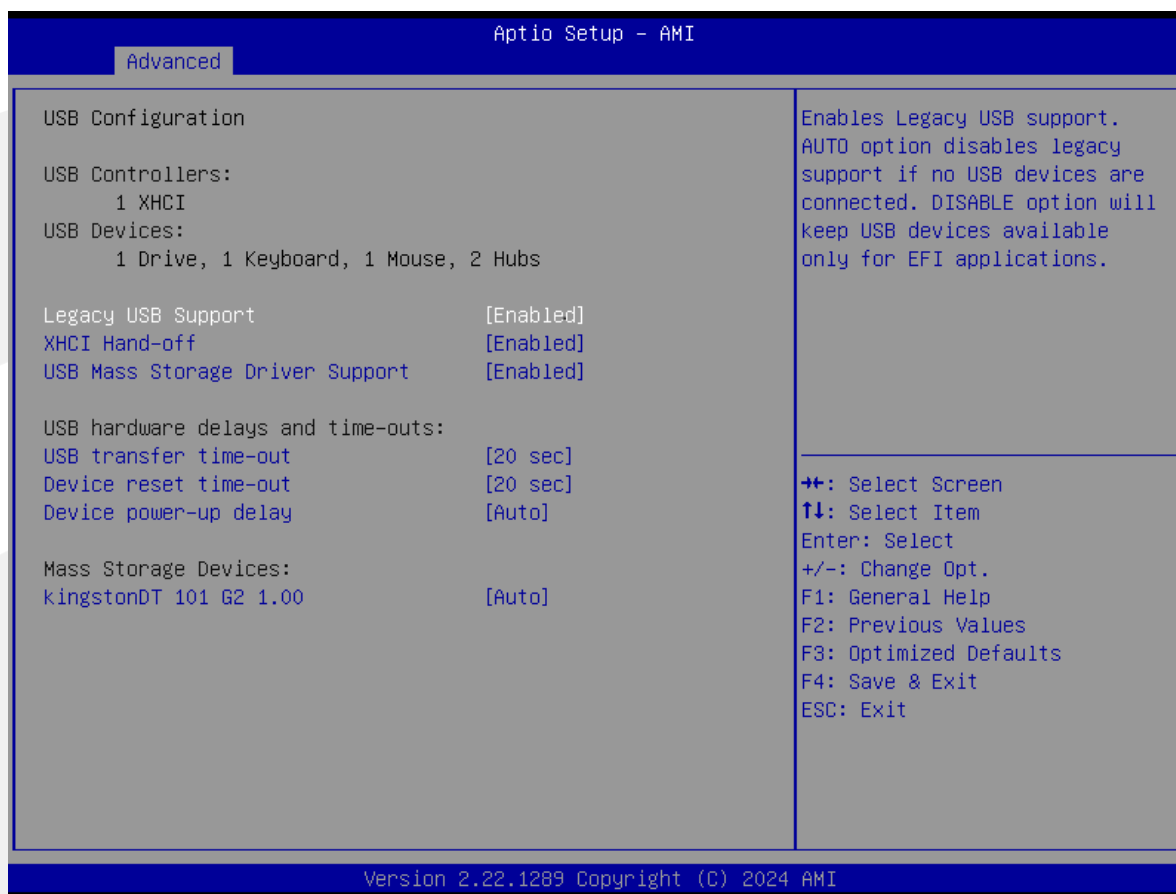

Setup Item	Options	Help Text	Comments
USB Configuration			
Legacy USB Support	Enabled Disabled	Enables Legacy USB support. AUTO option disables legacy support if no USB devices are connected. DISABLE option will keep USB devices available only for EFI applications.	
XHCI Hand-off	Enabled Disabled	This is a workaround for Oses without XHCI hand-off support. The XHCI ownership change should be claimed by XHCI driver.	
USB MASS Storage Driver Support	Enabled Disabled	Enable/Disable USB Mass Storage Driver Support.	
USB hardware delays and time-outs			
USB transfer time-out	1 sec 5 sec 10 sec 20 sec	The time-out value for Control, Bulk, and Interrupt transfers.	
Device reset time-out	1 sec 5 sec 10 sec 20 sec	USB mass storage device Start Unit command time-out.	
Device power-up delay	Auto Manual	Maximum time the device will take before it properly reports itself to the Host Controller. ' auto' uses default value: for a Root port it is 100ms,for a Hub port the delay is taken from Hub descriptor.	
Mass Storage Device			
kingstonDT 101 G2 1.00	Auto		

3.2.8 Network Stack Configuration

To access this screen from the Main screen, choose **Advanced > Network Stack Configuration**.



Setup Item	Options	Help Text	Comments
Network Stack Configuration			
Network Stack	Disabled Enabled		Enable/Disable UEFI Network Stack.
IPv4 PXE Support	Disabled Enabled		Enable/Disable IPv4 PXE boot support.
IPv4 HTTP Support	Disabled Enabled		Enable/Disable IPv4 HTTP boot support.
IPv6 PXE Support	Disabled Enabled		Enable/Disable IPv6 PXE boot support.
IPv6 HTTP Support	Disabled Enabled		Enable/Disable IPv6 HTTP boot support.
PXE boot wait time	0		
Media detect count	1		

3.2.9 CSM Configuration

The CSM Configuration screen allows the user to view the CSM information, and to enable or disable CSM options. To access this screen from the Main screen, choose **Advanced > CSM Configuration**.

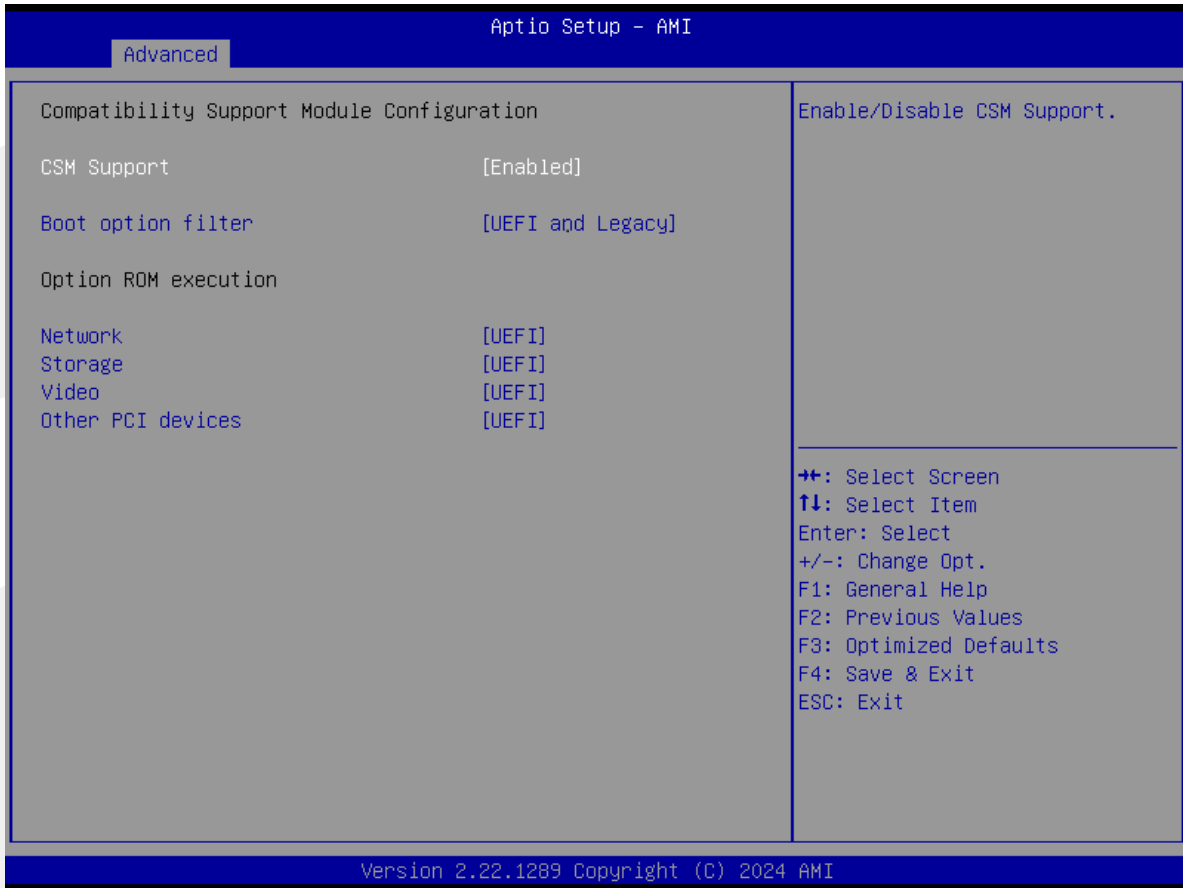

Setup Item	Options	Help Text	Comments
CSM Configuration			
CSM Support	Enabled Disabled	Enable / Disable CSM support.	
Boot option filter	UEFI and Legacy Legacy only UEFI only	This option control Legacy/UEFI ROMs priority.	
Network	Legacy UEFI Do not lunch	Control the execution of UEFI and Legacy PXE OpROM.	
Storage	Legacy UEFI Do not lunch	Control the execution of UEFI and Legacy Storage OpROM.	
Video	Legacy UEFI Do not lunch	Control the execution of UEFI and Legacy video OpROM.	
Other PCI devices	Legacy UEFI Do not lunch	Determines OpROM execution policy for devices other than Network,Storage or video.	

3.2.10 NVMe Configuration

The NVMe Configuration screen allows the user to view the NVMe Device information. To access this screen from the Main screen, choose **Advanced > NVMe Configuration**.



3.2.11 Watchdog Configuration

The Watchdog Configuration screen allows the user to Set System WatchDog Parameters. To access this screen from the Main screen, choose **Advanced > Watchdog Configuration**.

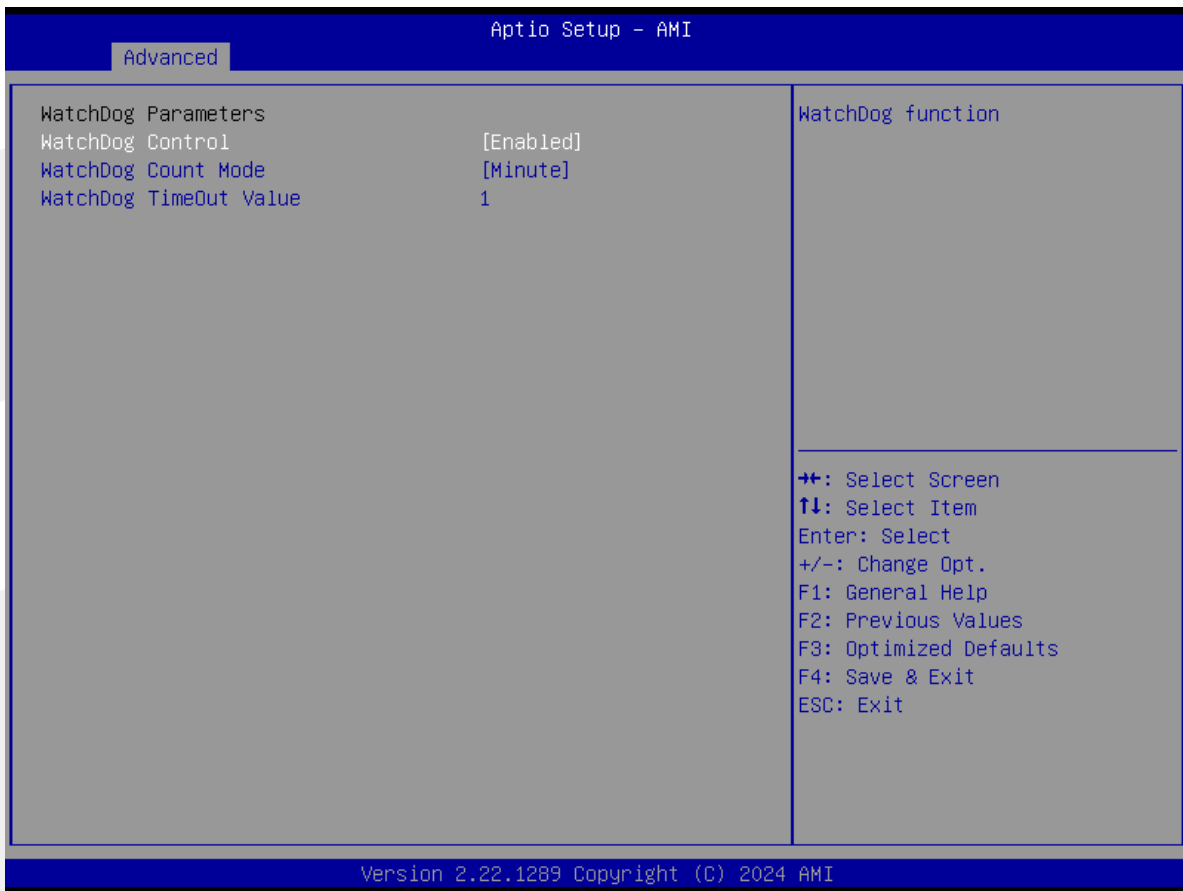

Setup Item	Options	Help Text	Comments
Watchdog Configuration			
WatchDog Control	Disabled Enabled		WatchDog function.
WatchDog Count Mode	Minute Second		WatchDog Count Mode Selection.
WatchDog TimeOut Value	1		Fill WatchDog TimeOut (0~255),0 means function disabled.

3.2.12 LVDS Panel

To access this screen from the Main screen, choose **Advanced > LVDS Panel**.



Setup Item	Options	Help Text	Comments
LVDS Panel			
LVDS Control	Disabled Enabled		Enable or Disable for LVDS control.
LVDS Panel	1024*768/24/Single		

3.3 Chipset Screen

The Chipset screen provides an access point to configure SA Configuration and PCH-IO configuration. To access this screen from the Main screen, press the right arrow until the Chipset screen is chosen.

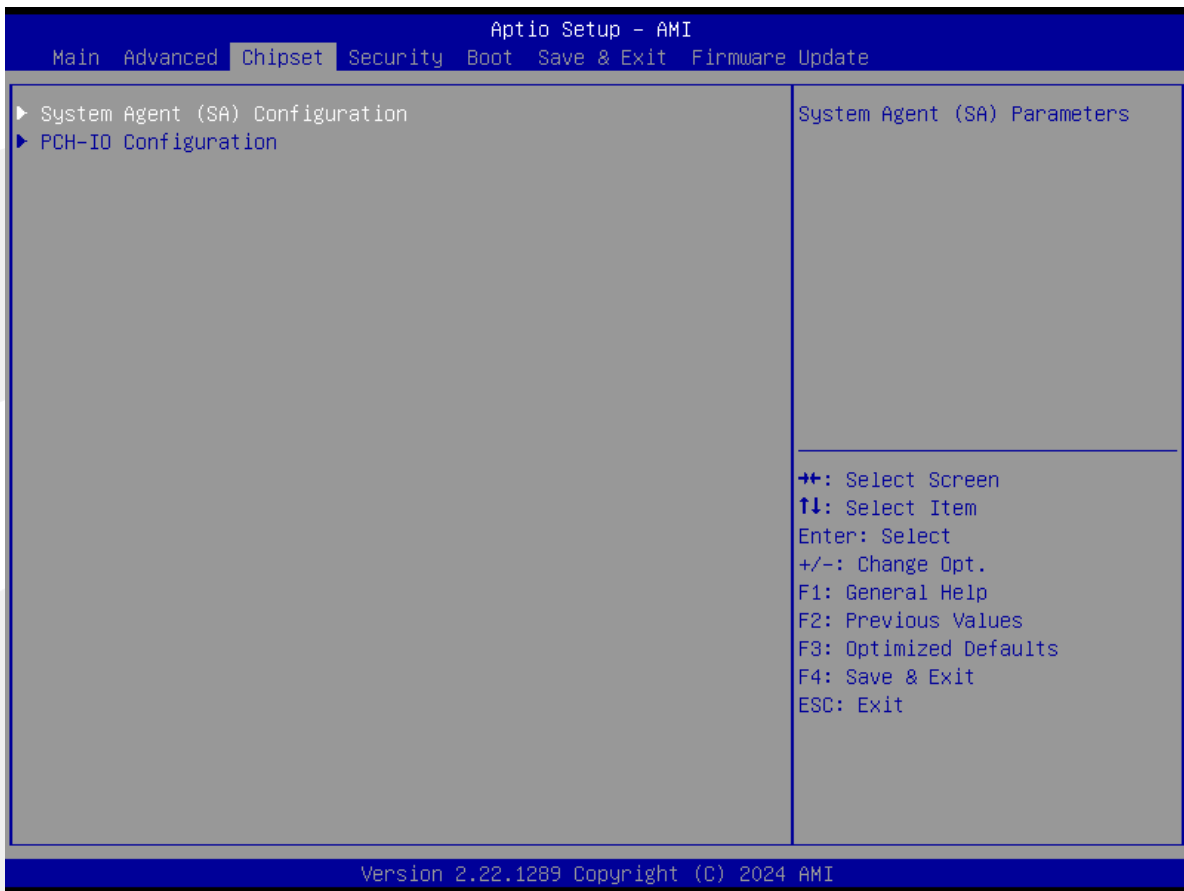

Setup Item	Options	Help Text	Comments
Chipset Screen			
System Agent (SA) Configuration		System Agent (SA) Parameters.	
PCH-IO Configuration		PCH Parameters.	

3.3.1 System Agent (SA) Configuration

The North Bridge Screen allows user to set NB chipset configuration. To access this screen, form the Main screen, choose **Chipset > System Agent (SA) Configuration**.

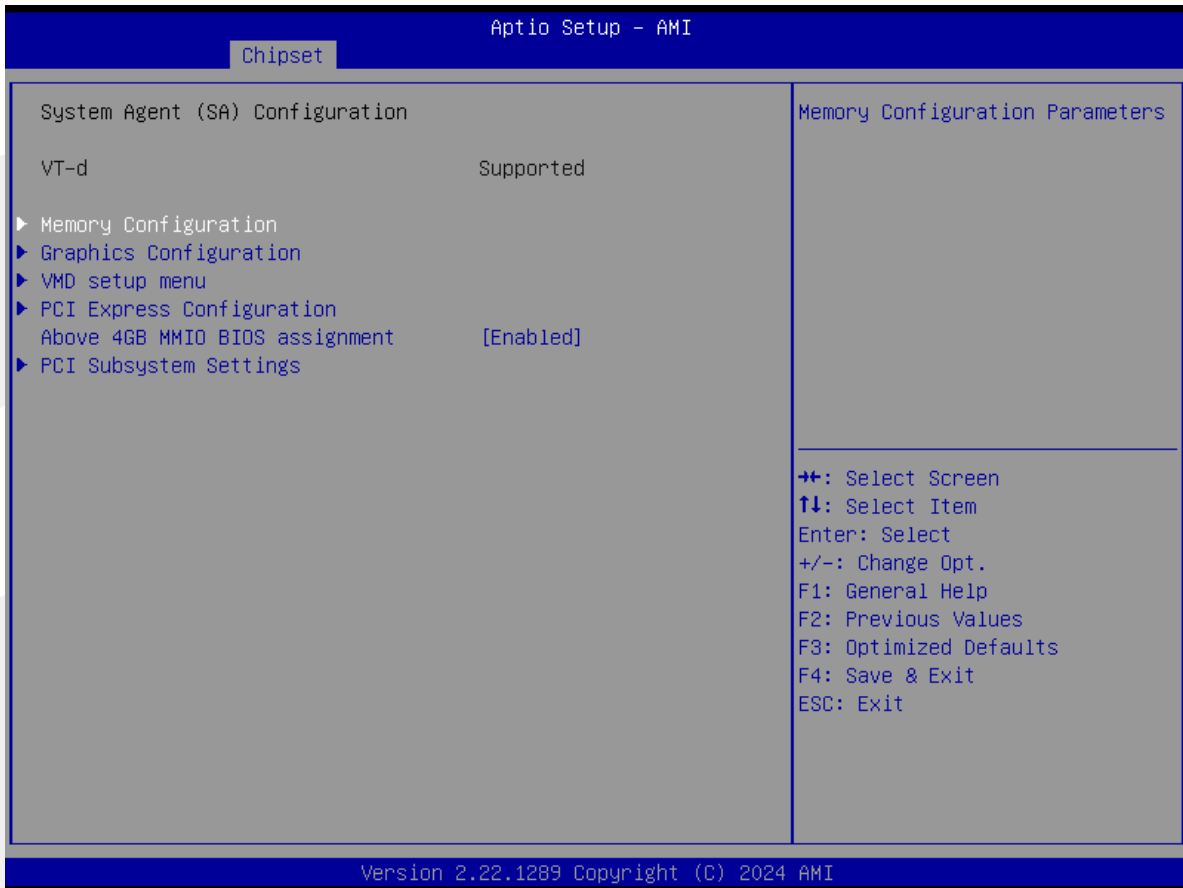

Aptio Setup - AMI

Chipset

System Agent (SA) Configuration	Memory Configuration Parameters
VT-d Supported ▶ Memory Configuration ▶ Graphics Configuration ▶ VMD setup menu ▶ PCI Express Configuration Above 4GB MMIO BIOS assignment [Enabled] ▶ PCI Subsystem Settings	++: Select Screen ↑↓: Select Item Enter: Select +/-: Change Opt. F1: General Help F2: Previous Values F3: Optimized Defaults F4: Save & Exit ESC: Exit

Version 2.22.1289 Copyright (C) 2024 AMI

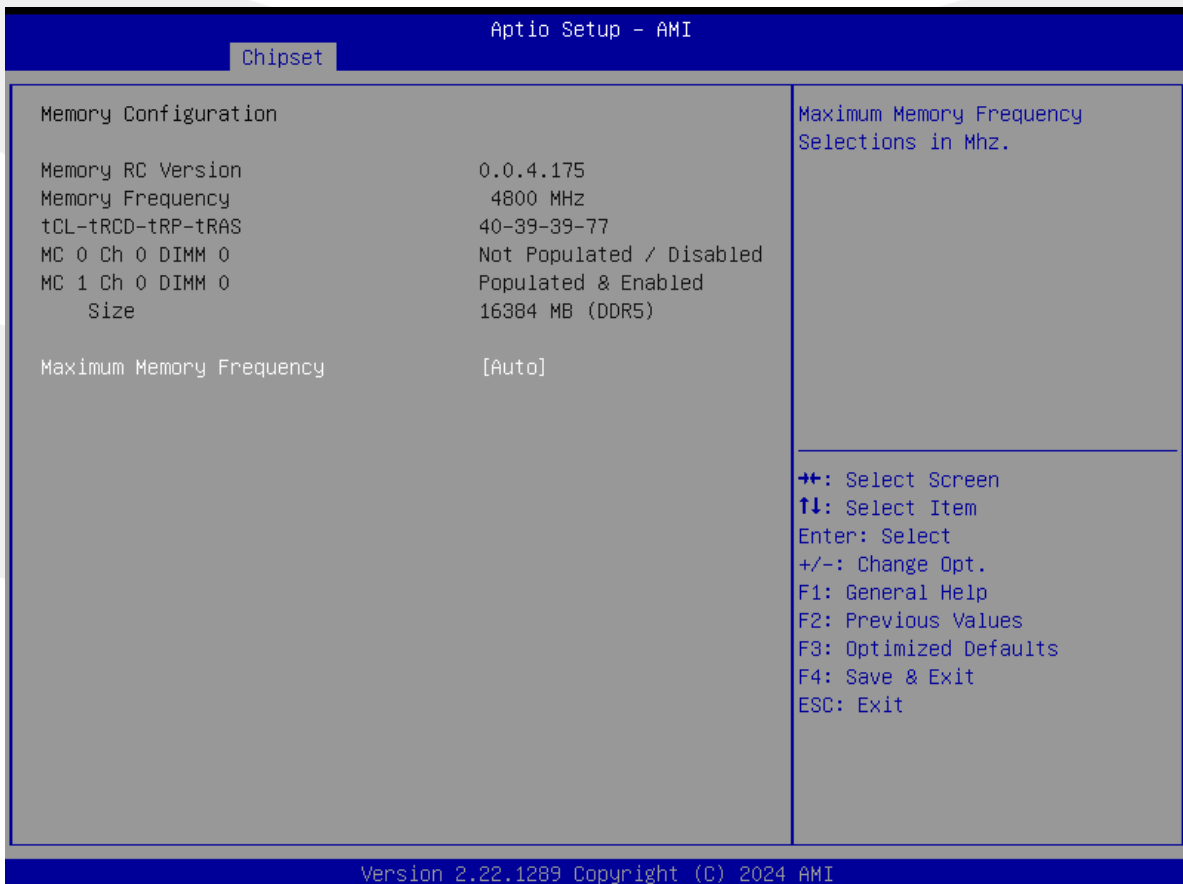

Aptio Setup - AMI

Chipset

Memory Configuration	Maximum Memory Frequency Selections in Mhz.
Memory RC Version 0.0.4.175 Memory Frequency 4800 MHz tCL-tRCD-tRP-tRAS 40-39-39-77 MC 0 Ch 0 DIMM 0 Not Populated / Disabled MC 1 Ch 0 DIMM 0 Populated & Enabled Size 16384 MB (DDR5) Maximum Memory Frequency [Auto]	++: Select Screen ↑↓: Select Item Enter: Select +/-: Change Opt. F1: General Help F2: Previous Values F3: Optimized Defaults F4: Save & Exit ESC: Exit

Version 2.22.1289 Copyright (C) 2024 AMI

Aptio Setup - AMI

Chipset

Graphics Configuration		Select which of IGFX/PEG/PCI Graphics device should be Primary Display Or select HG for Hybrid Gfx.
Primary Display	[Auto]	
Internal Graphics	[Auto]	
GTT Size	[8MB]	
Aperture Size	[256MB]	
DVMT Pre-Allocated	[60M]	
Intel Graphics Pei Display Peim	[Disabled]	
▶ LCD Control		

++: Select Screen
 ↑↓: Select Item
 Enter: Select
 +/-: Change Opt.
 F1: General Help
 F2: Previous Values
 F3: Optimized Defaults
 F4: Save & Exit
 ESC: Exit

Version 2.22.1289 Copyright (C) 2024 AMI

Aptio Setup - AMI

Chipset

PCI Express Configuration		Load Fia Configuration if Enabled for each root port.
Fia Programming	[Enabled]	
Compliance Test Mode	[Disabled]	
CDR Relock	[Enabled]	
Assertion on Link Down GPIOs	[Disabled]	
PCI Express Slot Selection	[CEMx4 slot]	
▶ PCI Express Root Port 1		
▶ PCI Express Root Port 2		
▶ PCI Express Root Port 3		

++: Select Screen
 ↑↓: Select Item
 Enter: Select
 +/-: Change Opt.
 F1: General Help
 F2: Previous Values
 F3: Optimized Defaults
 F4: Save & Exit
 ESC: Exit

Version 2.22.1289 Copyright (C) 2024 AMI

Setup Item	Options	Help Text	Comments
System Agent (SA) Configuration			
Memory Configuration			
Memory Information		Show Memory information.	
Graphics Configuration			
Primary Display	Auto IGFX PEG PCH	Select which of IGFX/PEG/PCI Graphics device should be Primary Display Or select HG for Hybrid Gfx.	
Internal Graphics	Auto Disabled Enabled	Keep IGFX enabled based on the setup options.	
GTT Size	2MB 4MB 8MB	Select the GTT Size.	
Aperture Size	128MB 256MB 512MB 1024MB 2048MB	Select the Aperture Size. Note: Above 4GB MMIO BIOS assignment is automatically enabled when selecting 2048MB aperture. To use this feature, please disable CSM Support.	
DVMT Total Gfx Mem	128M 256M MAX	Select DVMT5.0 Total Graphic Memory size used by the Internal Graphics Device.	

3.3.2 PCH-IO Configuration

The South Bridge Screen allows user to set SB chipset configuration. To access this screen form the Main screen, choose **Chipset > PCH-IO Configuration**.

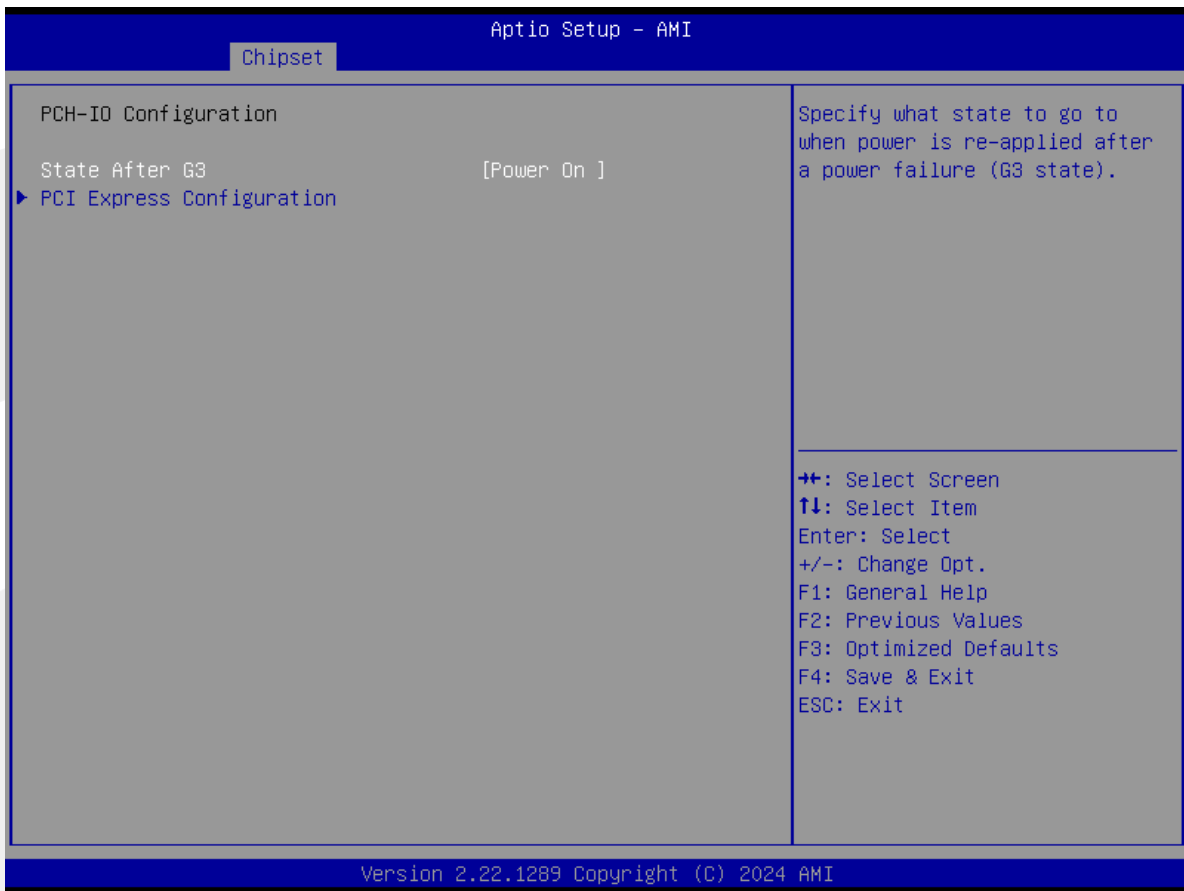

Setup Item	Options	Help Text	Comments
PCH-IO Configuration			
State After G3	Power On Power off	Select AC power state when power is re-applied after a power failure.	
PCI Express Configuration			

3.4 Security

To access this screen from the Main screen, choose **Security**.



Setup Item	Options	Help Text	Comments
Security			
Administrator Password		Set Administrator Password.	
User Password		Set User Password.	

3.5 Boot Screen

The Boot screen displays any bootable media encountered during POST, and allows the user to configure desired boot device. To access this screen from the Main screen, choose **Boot**.

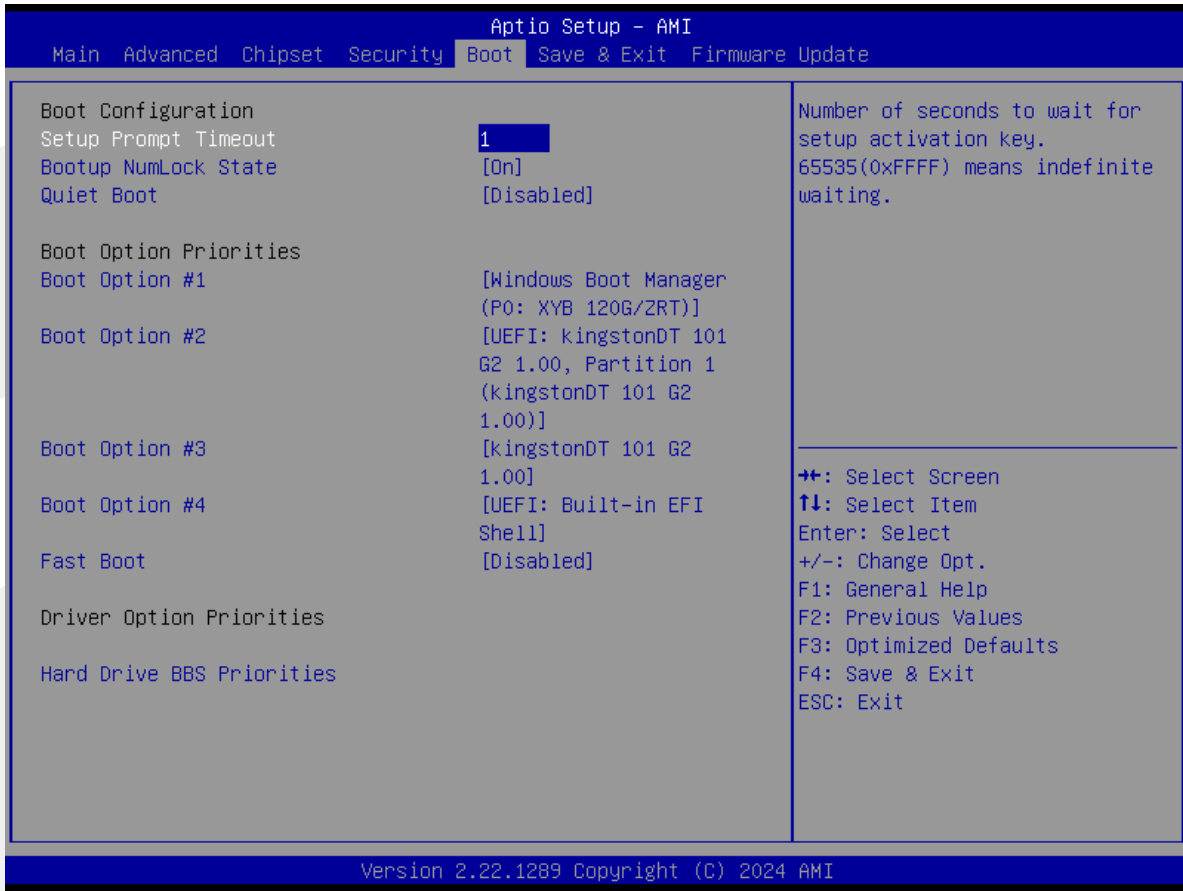

Setup Item	Options	Help Text	Comments
Boot Configuration			
Setup Prompt Timeout	1~65535	Number of seconds to wait for setup activation key.65535(0xFFFF) means indefinite waiting.	Setup Prompt Timeout.
Bootup NumLock State	On off	Select the keyboard Number state.	Bootup NumLock State.
Quiet Boot	Disabled Enabled	Enables or disables Quiet Boot option.	Quiet Boot.
Boot Option Priorities			
Boot Option #1		Sets the system boot order.	
Boot Option #2		Sets the system boot order.	Note: Showed When boot devices existed.
Boot Option #3		Sets the system boot order.	

Setup Item	Options	Help Text	Comments
Boot Option #4		Sets the system boot order.	
Fast Boot	Disabled		
Driver Option Priorities			
Hard Drive BBS Priorities		Set the order of the legacy devices in this group.	Set boot order in each group of the same kind, such as HDD, network

3.6 Save & Exit Screen

The Save & Exit screen allows the user to choose whether to save or discard the configuration changes made on the other screens. It also allows the user to restore the server to the factory defaults or to save or restore them to set of user-defined default values.

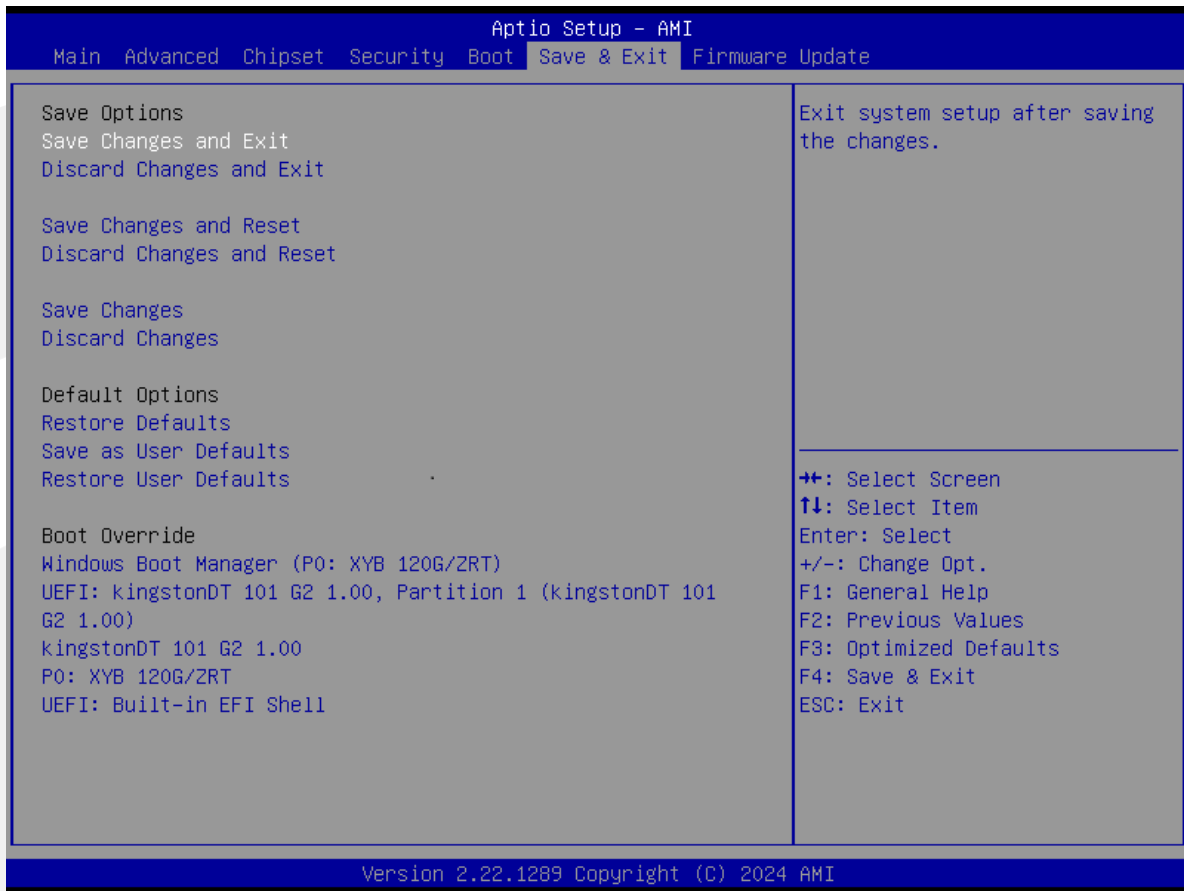

Setup Item	Options	Help Text	Comments
Save & Exit			
Save Options			
Save Changes and Exit		Exit system setup after saving the changes.	User is prompted for confirmation only if any of the setup fields were modified.
Discard Changes and Exit		Exit system setup without saving any changes.	
Save Changes and Reset		Reset the system after saving the changes.	
Discard Changes and Reset		Reset system setup without saving and changes.	
Save Changes		Save Changes done so far to any of the setup options.	
Discard Changes		Discard Changes done so far to any or the setup options.	

Setup Item	Options	Help Text	Comments
Default Options			
Restore Defaults		Restore/Load Default values for all the setup options.	
Save as User Defaults		Save the changes done so far as User Defaults.	
Restore User Defaults		Restore the User Defaults to all the setup options.	
Boot Override			
Shows the Device can boot.			Note: Showed When boot devices existed.

3.7 Firmware Update(optional)

This is an alternative to updating the BIOS entry, contact technical support to operate.

第四章 Electrical Specifications

4.1 Input Power - General Considerations

The Compact, Basic and Extended Module Modules shall use a single main power rail with a nominal value of +12V. The Mini Module shall support a wide range power supply of 4.75V to 20.0V. In addition, the Mini Module shall be optimized for 5V operation and Module vendors should report Module power figures at 5V, 12V and 18V input voltages.

Two additional rails are specified: a +5V standby power rail and a +3V battery input to power the Module Real-time Clock (RTC) circuit in the absence of other power sources. The +5V standby rail may be left unconnected on the Carrier Board if the standby functions are not required by the application. Likewise, the +3V battery input may be left open if the application does not require the RTC to keep time in the absence of the main and standby sources. There may be Module specific concerns regarding storage of system setup parameters that may be affected by the absence of the +5V standby and / or the +3V battery.

The rationale for this power-delivery scheme is:

- Module pins are scarce. It is more pin-efficient to bring power in on a higher voltage rail.
- Single supply operation is attractive to many users.
- Lithium ion battery packs for mobile systems are most prevalent with a +14.4V output. This is well suited for the +12V main power rail.
- Contemporary chipsets have no power requirements for +5V other than to provide a reference voltage for +5V tolerant inputs. No COM Express Module pins are allocated to accept +5V except for the +5V standby pins. In the case of an ATX supply, the switched (non standby) +5V line would not be used for the COM Express Module, but it might be used elsewhere on the Carrier Board.

4.2 Input Power - Current Load

The Module connector pins limit the amount of power that can be brought into the COM Express Module. The limits are different for Module Pin-out Type 10 vs. Pin-out Types 6 and 7, based on the number of 12V power pins as Pin-out Type 10 has fewer pins available.

Table 4.1: Input Power - Pin-Out Type 10 Modules (Single Connector, 220 pins)

Power Rail	Module Pin Current Capability (Amps)	Nominal Input (Volts)	Input Range (Volts)	Derated Input (Volts)	Max Input Ripple (mV)	Max Module Input Power (w. derated input) (Watts)	Assumed Conversion Efficiency	Max Load Power (Watts)
VCC_12V	6	12	11.4 - 12.6	11.4	+/-100	68	85%	58
Wide input (Mini)	6		4.75 – 20.0	4.75	+/-100	28		
VCC_5V_SBY	2	5	4.75 - 5.25	4.75	+/-50	9		
VCC_RTC	0.5	3	2.0 - 3.3		+/-20			

Table 4.2: Input Power - Pin-Out Type 6/7 Modules (Dual Connector, 440 pins)

Power Rail	Module Pin Current Capability (Amps)	Nominal Input (Volts)	Input Range (Volts)	Derated Input (Volts)	Max Input Ripple (mV)	Max Module Input Power (w. derated input) (Watts)	Assumed Conversion Efficiency	Max Load Power (Watts)
VCC_12V	12	12	11.4 - 12.6	11.4	+/-100	137	85%	116
VCC_5V_SBY	2	5	4.75 - 5.25	4.75	+/-50	9		
VCC_RTC	0.5	3	2.0 - 3.3		+/-20			

The ripple voltage, if present, must not cause the input voltage range to be exceeded.

4.3 Input Power - Sequencing

COM Express input power sequencing requirements are as follows:

- VCC_RTC shall come up at the same time or before VCC_5V_SBY comes up(if use)
 - VCC_5V_SBY shall come up at the same time or before VCC_12V comes up(if use)
 - PWR_OK shall be active at the same time or after VCC_12V comes up(if use)
 - PWR_OK shall be inactive at the same time or before VCC_12V goes down(if use)
 - VCC_12V shall go down at the same time or before VCC_5V_SBY goes down
 - VCC_5V_SBY shall go down at the same time or before VCC_RTC goes down(if use)
- Wide input (Mini) shall follow the power sequencing of the VCC_12V

Figure 4-1: Power Sequencing

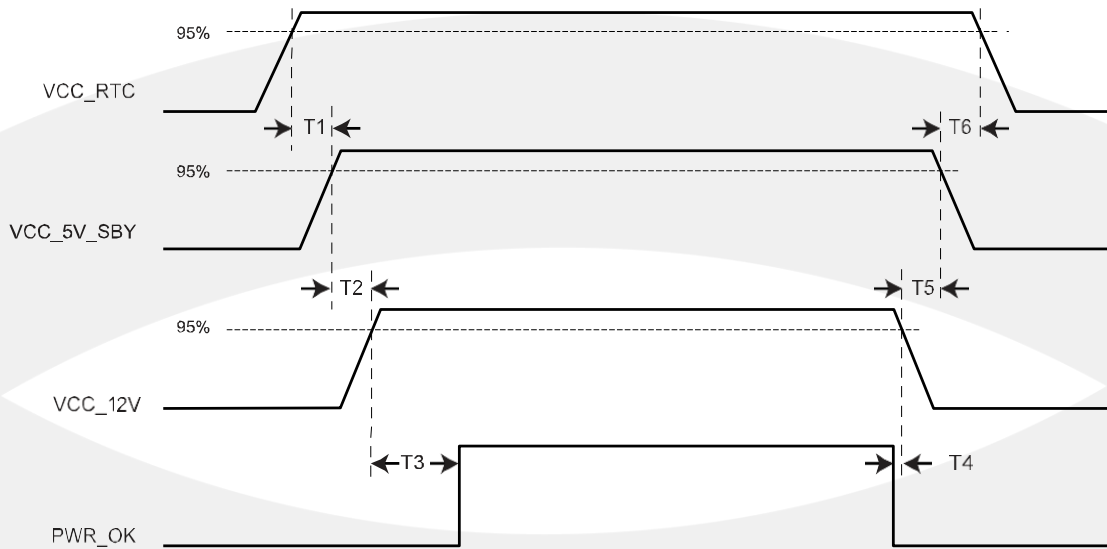

Table 4.3: Power Sequencing

T1	VCC_RTC rise to VCC_5V_SBY rise	≥ 0 ms
T2	VCC_5V_SBY rise to VCC_12V rise	≥ 0 ms
T3	VCC_12V rise to PWROK rise	≥ 0 ms
T4	PWR_OK fall to VCC_12V fall	≥ 0 ms
T5	VCC_12V fall to VCC_5V_SBY fall	≥ 0 ms
T6	VCC_5V_SBY fall to VCC_RTC fall	≥ 0 ms

4.4 Input Power - Rise Time

The input voltages to the COM Express Module VCC_12V, wide input (Mini) and VCC_5V_SBY if used shall rise from $\leq 10\%$ of nominal to within the regulation ranges within 0.1 ms to 20 ms ($0.1 \text{ ms} \leq T_2 \leq 20 \text{ ms}$). There must be a smooth and continuous ramp of each DC output voltage from 10% to 90% of its final set point within the regulation band. The smooth turn-on requires that, during the 10% to 90% portion of the rise time, the slope of the turn-on waveform must be positive and have a value of between 0 V/ms and $[\text{Vout, nominal} / 0.1] \text{ V/ms}$. Also, for any 5ms segment of the 10% to 90% rise time waveform, a straight line drawn between the end points of the waveform segment must have a slope $\geq [\text{Vout, nominal} / 20] \text{ V/ms}$.

Figure 4-2: Input Power Rise Time

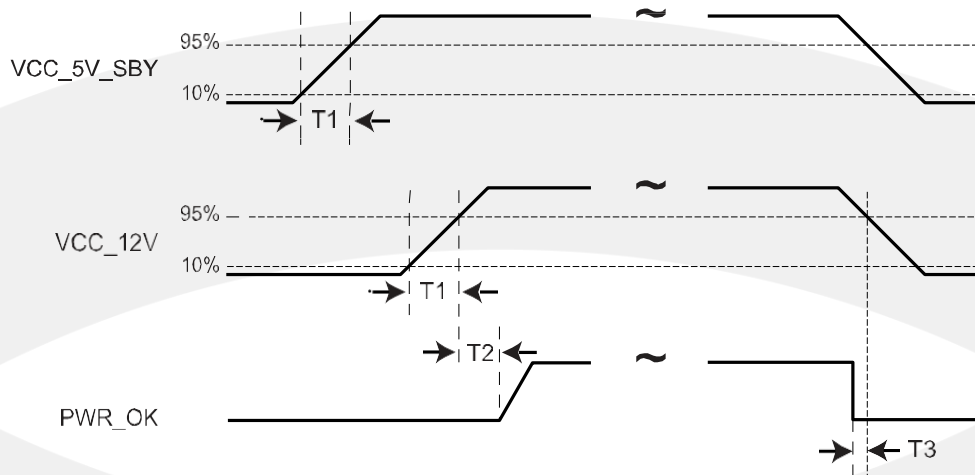

- $T1, \text{min} = 0,1 \text{ms}$
- $T1, \text{max} = 20 \text{ms}$
- $T2 \geq 0 \text{ms}$
- $T3 \geq 0 \text{ms}$

The values chosen were selected to be compatible and enable use of ATX specification R2.2.

4.5 Signal Integrity Requirements

The signal groups listed in the following table have signal-integrity concerns that should be accounted for in Module and Carrier Board designs. A general description is shown in the table for reference only. The designer should consult the relevant interface specification documents for complete information.

Table 4.4: Signal Integrity Requirements

Signal Group	General Description	Source Spec Reference
Gigabit Ethernet	Differential pairs	IEEE 802.3 Specification
LVDS	100Ω edge coupled differential pairs	National Semiconductor LVDS web site
PCI and LPC clocks	50Ω single ended ground-referenced	
PCI Express	Differential pairs	PCI SIG - PCI Express Specification
PCI Express clocks	100Ω edge couple differential pair, ground-referenced	
Serial ATA	Differential pairs	SATA Specification
USB	Differential pairs	USB 2.0 Specification
10GBASE-KR	Differential pairs	IEEE 802.3 Specification
USB SS	Differential pairs	USB 3.0 Specification
SPI	50Ω single ended ground-referenced	
eSPI	50Ω single ended ground-referenced	

第五章 故障问题排除

故障	排除
U 系列支持显卡	BIOS 下关闭 CSM，设置 IGFX 优先，进系统装驱动后重启多次可以正常显示。

附录

附一：术语表

ACPI

高级配置和电源管理。ACPI 规范允许操作系统控制计算机及其附加设备的大部份电能。

BIOS

基本输入/输出系统。是在 PC 中包含所有的输入/输出控制代码界面的软件。它在系统启动时进行硬件检测，开始操作系统的运作，在操作系统和硬件之间提供一个界面。BIOS 是存储在一个只读存储器芯片内。

BUS

总线。在计算机系统中，不同部件之间交换数据的通道，是一组硬件线路。我们所指的 BUS 通常是 CPU 和主内存元件内部的局部线路。

Chipset

芯片组。是为执行一个或多个相关功能而设计的集成芯片。我们指的是由南桥和北桥组成的系统级芯片组，他决定了主板的架构和主要功能。

CMOS

互补金属-氧化物半导体。是一种被广泛应用的半导体类型。它具有高速、低功耗的特点。我们指的 CMOS 是在主板上的 CMOS RAM 中预留的一部份空间，用来保存日期、时间、系统信息和系统参数设定信息等。

COM

串口。一种通用的串行通信接口，一般采用标准 DB9 公头接口连接方式。

DIMM

双列直插式内存模块。是一个带有内存芯片组的小电路板。提供 64bit 的内存总线宽度。

DRAM

动态随机存取存储器。是一个普通计算机的通用内存类型。通常用一个晶体管和一个电容来存储一个位。随着技术的发展，DRAM 的类型和规格已经在计算机应用中变得越来越多样化。例如现在常用的就有 SDRAM、DDR SDRAM 和 RDRAM。

I2C

Inter-Integrated Circuit 总线是一种由 PHILIPS 公司开发的两线式串行总线，用于连接微控制器及其外围设备。

LAN

局域网络接口。一个小区域内相互关联的计算机组成的一个计算机网络，一般是在一个企事业单位或一栋建筑物。局域网一般由服务器、工作站、一些通信链接组成，一个终端可以通过电线访问数据和设备的任何地方，许多用户可以共享昂贵的设备和资源。

LED

发光二极管，一种半导体设备，当电流流过时它会被点亮，通常用来把信息非常直观地表示出来，例如表示电源已经导通或硬盘驱动器正在工作等。

PnP

即插即用。允许 PC 对外接设备进行自动配置，不用用户手动操作系统就可以自己工作的一种规格。为实现这个特点，BIOS 支持 PnP 和一个 PnP 扩展卡都是必需的。

POST

上电自检。在启动系统期间，BIOS 会对系统执行一个连续的检测操作，包括检测 RAM，键盘，硬盘驱动器等，看它们是否正确连接和是否正常工作。

PS/2

由 IBM 发展的一种键盘和鼠标连接的接口规范。PS/2 是一个仅有 6PIN 的 DIN 接口，也可以用以连接其他的设备，比如调制解调器。

USB

通用串行总线。一种适合低速外围设备的硬件接口，一般用来连接键盘、鼠标等。一台 PC 最多可以连接 127 个 USB 设备，提供一个 12Mbit/s 的传输带宽；USB 支持热插拔和多数数据流功能即在系统工作时可以插入 USB 设备，系统可以自动识别并让插入的设备正常。

深圳智锐通科技有限公司
Shenzhen Zrt Co., Ltd.



智锐通公众号

&



智锐通抖音号

- 集团总部：深圳市宝安区碧桂园凤凰智谷A栋21楼
 - 北京分公司：北京市昌平区科兴西路106号院2号楼5层
 - 南京分公司：南京市江宁区万科都荟天地B2栋7楼
 - 苏州分公司：苏州市虎丘区港龙城市广场4栋13楼
 - 成都分公司：成都市武侯区世纪百合尚寓3栋10楼
- 400-838-6869