

1. Specifications:

Model	MMP2000A5-4G
GPU Architecture	NVIDIA Pascal
Graphics Processing Unit	NVIDIA Quadro Embedded P2000
NVIDIA CUDA Core	768
Bus Type	MXM3 .1 / up to PCI Express 3.0
Graphics Clock	1455MHz / 1481MHz (Boost)
Single Precision FLOPS	2214GFLOPS
Double Precision FLOPS	69.76GFLOPS
Memory Size	4G 128bit GDDR5
Memory Clock	1502MHz (6.0 Gbps)
Memory Bandwidth	96.1 GB/s
Display Features	DP_A: Display Port1.4++ DP_B: Display Port1.4++ DP_C: Display Port1.4++ DP_D: Display Port1.4++
Max Resolution	7680x4320@120Hz
Board Power	75W
Board Dimensions	MXM Graphics Module Version 3.1 Type A (70x82mm)
Number of output Channel	4
Operation System	Windows 10 64bit 、Linux 64bit
VIN Range	DC 12~19V, 3.3V & 5V; +/-5%

OpenGL	4.6
OpenCL	1.2
DirectX	12
Video Playback	H.265, VC1, MPEG2 1080P

Operating Temperature	0~45°C
Storage Temperature	-20~75°C
Operating Humidity	0~95% (non-condensing)
Storage Humidity	10~90%

2.MXM Board Outlines:

Figure 2.1 shows the board outlines (top side view) for Type A MXM modules. An additional system keep-out of 0.5mm [0.020] per side is allowed on the PCB to accommodate whatever means of production panelization is required. This additional clearance is above and beyond the dimensional limits presented here. The location of these features is not specified or controlled.

Figure 2.1: Board Outlines

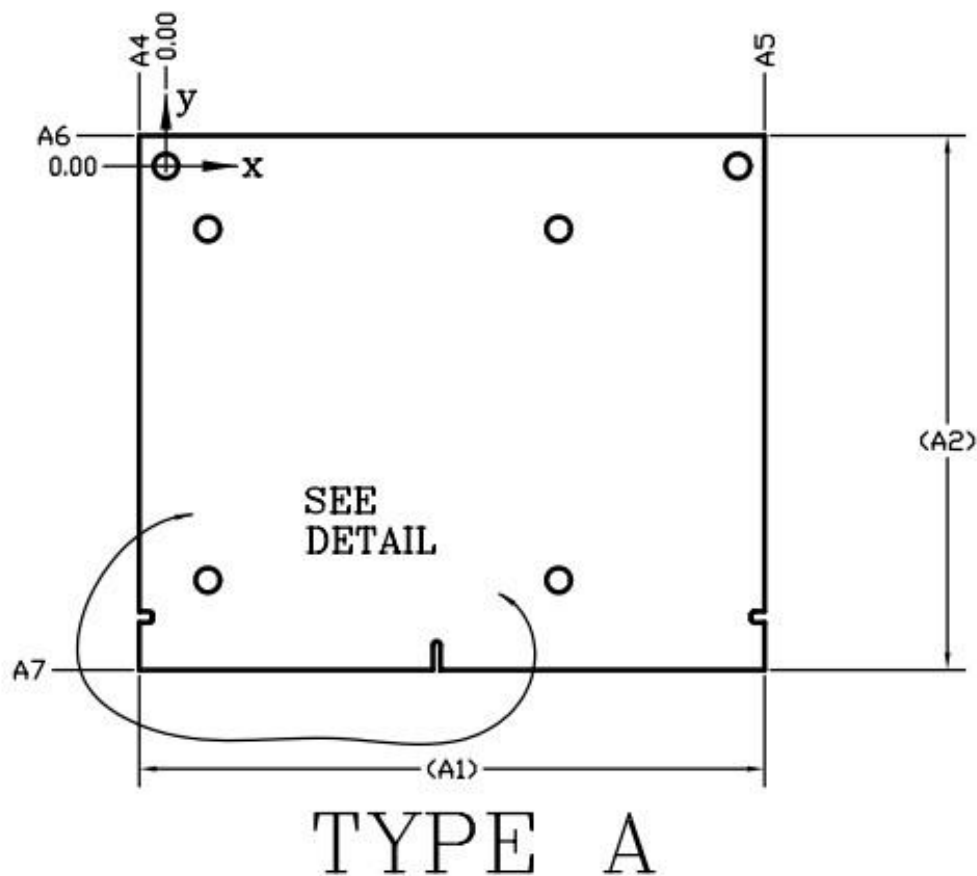

Table 2.1: Board Outline Dimensions

Symbol	[mm]			[in]		
	min	nom	max	min	nom	max
A1		82.00			3.228	
A3		105.00			4.134	
A4	3.37	3.50	3.63	0.133	0.138	0.143
A5	78.37	78.50	78.63	3.085	3.091	3.096
A7	65.87	66.00	66.13	2.593	2.598	2.604
A8	38.87	39.00	39.13	1.530	1.535	1.541

Figure 2.2: Board Slots Detail

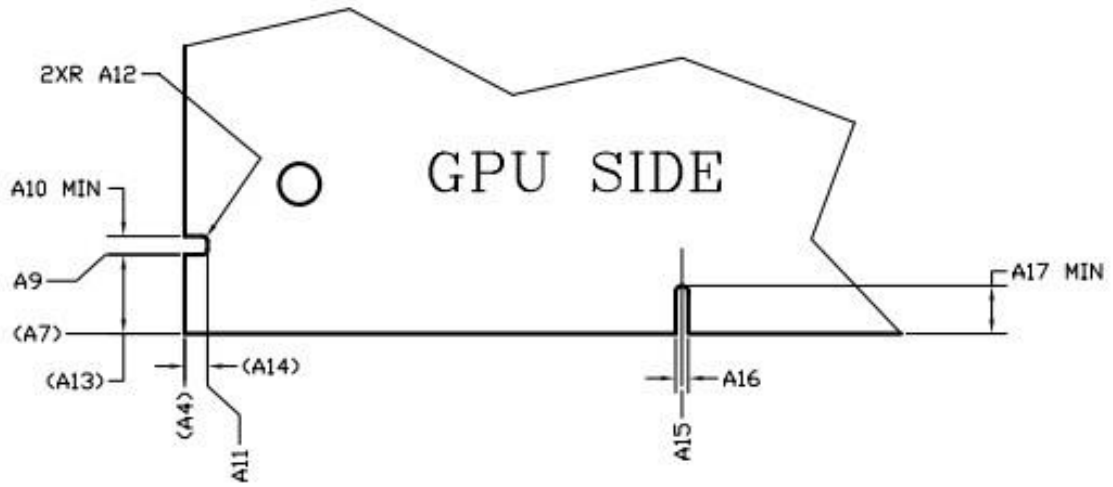

Table 2.2: Board Slots Dimensions

Symbol	[mm]			[in]		
	min	nom	max	min	nom	max
A4		3.50			0.138	
A7		66.00			2.598	
A9	59.67	59.80	59.93	2.349	2.354	2.359
A10	1.45			0.057		
A11	1.57	1.70	1.83	0.062	0.067	0.072
A12	0.32	0.50	0.58	0.013	0.020	0.023
A13		6.20			0.244	
A14		1.80			0.071	
A15	35.37	35.50	35.63	1.393	1.398	1.403
A16	0.95	1.00	1.05	0.037	0.039	0.041
A17	3.75			0.148		

3.MXM PCB Mounting Holes:

All MXM version 3.1 modules have 6 holes. Two are used to secure the board to the system and the other four to fasten the thermal solution to the module.

Figure 3.1: Mounting Holes

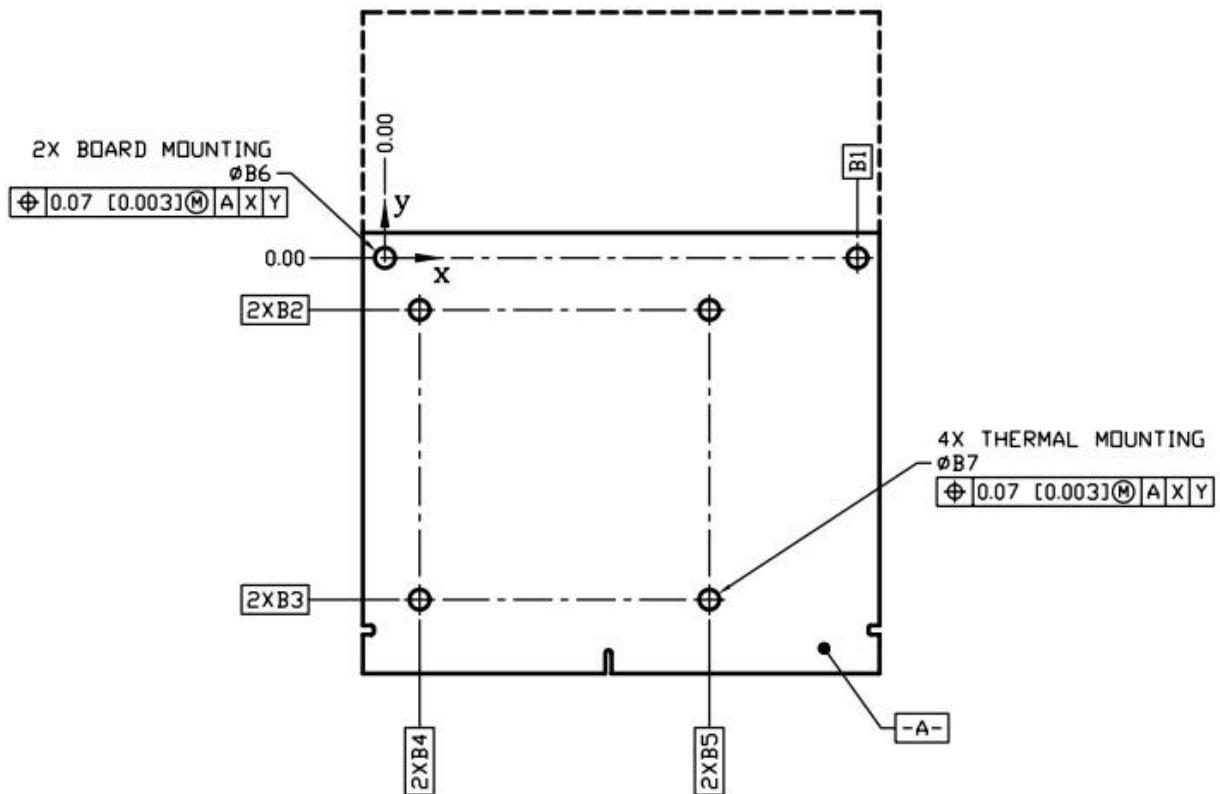

Table 3.1: Mounting Holes Dimensions

Symbol	[mm]			[in]		
	min	nom	max	min	nom	max
B1		75.00			2.953	
B2		8.25			0.325	
B3		54.25			2.136	
B4		5.50			0.217	
B5		51.50			2.028	
B6	3.07	3.20	3.33	0.121	0.126	0.131
B7	3.07	3.20	3.33	0.121	0.126	0.131

4.Connector Pinout:

Table 4.1, Table 4.2 and Table 4.3 list the connector pinout.

Table 4.1: Connector Pinout

Pin	Signal Name	Pin	Signal Name	Pin	Signal Name	Pin	Signal Name
E1	PWR_SRC	E2	PWR_SRC	51	PEX_RX15	52	GND
E3	GND	E4	GND	53	GND	54	PEX_TX14#
1	5V	2	PRSNT_R	55	PEX_RX14#	56	PEX_TX14
3	5V	4	WAKE	57	PEX_RX14	58	GND
5	5V	6	PWR_GOOD	59	GND	60	PEX_TX13#
7	5V	8	PWR_EN	61	PEX_RX13#	62	PEX_TX13
9	5V	10	27MHZ_REF	63	PEX_RX13	64	GND
11	GND	12	GND	65	GND	66	PEX_TX12#
13	GND	14	LVDS_U_HPD DP_F_HPD	67	PEX_RX12#	68	PEX_TX12
15	GND	16	RSVD	69	PEX_RX12	70	GND
17	GND	18	PWR_LEVEL	71	GND	72	PEX_TX11#
19	PEX_STD_SW#	20	TH_OVERT#	73	PEX_RX11#	74	PEX_TX11
21	VGA_DISABLE#	22	TH_ALERT#	75	PEX_RX11	76	GND
23	N/A	24	TH_PWM	77	GND	78	PEX_TX10#
25	N/A	26	GPIO0	79	PEX_RX10#	80	PEX_TX10
27	N/A	28	GPIO1	81	PEX_RX10	82	GND
29	HDMI_CEC	30	GPIO2	83	GND	84	PEX_TX9#
31	LVDS_L_HPD DP_E_HPD	32	SMB_DAT	85	PEX_RX9#	86	PEX_TX9
33	LVDS_DDC_DAT NC	34	SMB_CLK	87	PEX_RX9	88	GND
35	LVDS_DDC_CLK NC	36	GND	89	GND	90	PEX_TX8#
37	GND	38	OEM0	91	PEX_RX8#	92	PEX_TX8
39	OEM1	40	OEM2	93	PEX_RX8	94	GND
41	OEM3	42	OEM4	95	GND	96	PEX_TX7#
43	OEM5	44	OEM6	97	PEX_RX7#	98	PEX_TX7
45	OEM7	46	GND	99	PEX_RX7	100	GND
47	GND	48	PEX_TX15#	101	GND	102	PEX_TX6#
49	PEX_RX15#	50	PEX_TX15	103	PEX_RX6#	104	PEX_TX6

Table 4.2: Connector Pinout(continued)

Pin	Signal Name	Pin	Signal Name	Pin	Signal Name	Pin	Signal Name
105	PEX_RX6	106	GND	153	PEX_REFCLK#	154	PEX_CLK_REQ
107	GND	108	PEX_TX5#	155	PEX_REFCLK	156	PEX_RST#
109	PEX_RX5#	110	PEX_TX5	157	GND	158	VGA_DDC_DAT
111	PEX_RX5	112	GND	159	JTAG_TDO	160	VGA_DDC_CLK
113	GND	114	PEX_TX4#	161	JTAG_TDI	162	VGA_VSYNC
115	PEX_RX4#	116	PEX_TX4	163	JTAG_TCLK	164	VGA_HSYNC
117	PEX_RX4	118	GND	165	JTAG_TMS	166	GND
119	GND	120	PEX_TX3#	167	JTAG_TRST	168	VGA_RED
121	PEX_RX3#	122	PEX_TX3	169	DP_F_L3 LVDS_UCLK#	170	VGA_GREEN
123	PEX_RX3	124	GND	171	DP_F_L3 LVDS_UCLK	172	VGA_BLUE
125	GND	126	KEY	173	GND	174	GND
127	KEY	128	KEY	175	DP_F_AUX LVDS_UTX3#	176	DP_E_L3 LVDS_LCLK#
129	KEY	130	KEY	177	DP_F_AUX LVDS_UTX3	178	DP_E_L3 LVDS_LCLK
131	KEY	132	KEY	179	GND	180	GND
133	GND	134	GND	181	DP_F_L0 LVDS_UTX2#	182	DP_E_AUX LVDS_LTX3#
135	PEX_RX2#	136	PEX_TX2#	183	DP_F_L0 LVDS_UTX2	184	DP_E_AUX LVDS_LTX3
137	PEX_RX2	138	PEX_TX2	185	GND	186	GND
139	GND	140	GND	187	DP_F_L1 LVDS_UTX1#	188	DP_E_L0 LVDS_LTX2#
141	PEX_RX1#	142	PEX_TX1#	189	DP_F_L1 LVDS_UTX1	190	DP_E_L0 LVDS_LTX2
143	PEX_RX1	144	PEX_TX1	191	GND	192	GND
145	GND	146	GND	193	DP_F_L2 LVDS_UTX0#	194	DP_E_L1 LVDS_LTX1#
147	PEX_RX0#	148	PEX_TX0#	195	DP_F_L2 LVDS_UTX0	196	DP_E_L1 LVDS_LTX1
149	REX_RX0	150	PEX_TX0	197	GND	198	GND
151	GND	152	GND	199	DP_C_L0#	200	DP_E_L2 LVDS_LTX0#

Table 4.3: Connector Pinout(continued)

Pin	Signal Name	Pin	Signal Name	Pin	Signal Name	Pin	Signal Name
201	DP_C_L0	202	DP_E_L2 LVDS_LTX0	243	RSVD	244	GND
203	GND	204	GND	245	RSVD	246	DP_B_L0#
205	DP_C_L1#	206	DP_D_L0#	247	RSVD	248	DP_B_L0
207	DP_C_L1	208	DP_D_L0	249	RSVD	250	GND
209	GND	210	GND	251	GND	252	DP_B_L1#
211	DP_C_L2#	212	DP_D_L1#	253	DP_A_L0#	254	DP_B_L1
213	DP_C_L2	214	DP_D_L1	255	DP_A_L0	256	GND
215	GND	216	GND	257	GND	258	DP_B_L2#
217	DP_C_L3#	218	DP_D_L2#	259	DP_A_L1#	260	DP_B_L2
219	DP_C_L3	220	DP_D_L2	261	DP_A_L1	262	GND
221	GND	222	GND	263	GND	264	DP_B_L3#
223	DP_C_AUX#	224	DP_D_L3#	265	DP_A_L2#	266	DP_B_L3
225	DP_C_AUX	226	DP_D_L3	267	DP_A_L2	268	GND
227	RSVD	228	GND	269	GND	270	DP_B_AUX#
229	RSVD	230	DP_D_AUX#	271	DP_A_L3#	272	DP_B_AUX
231	RSVD	232	DP_D_AUX	273	DP_A_L3	274	DP_B_HPDP
233	RSVD	234	DP_C_HPDP	275	GND	276	DP_A_HPDP
235	RSVD	236	DP_D_HPDP	277	DP_A_AUX#	278	3V3
237	RSVD	238	RSVD	279	DP_A_AUX	280	3V3
239	RSVD	240	3V3	281	PRSNT_L	-	
241	RSVD	242	3V3				

5.MXM Connector:

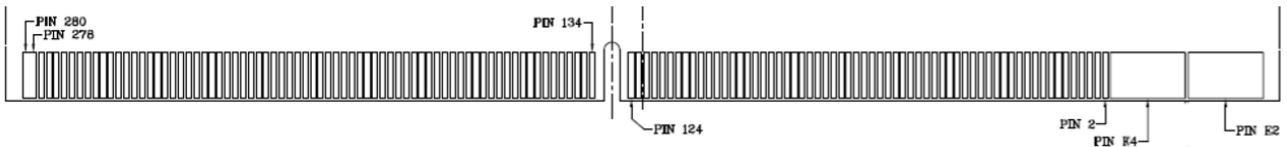

Figure 5.1 MXM Connector (Card Top)

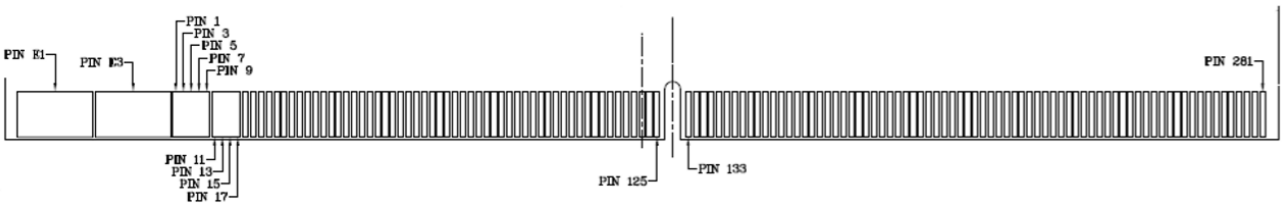

Figure 5.2 MXM Connector (Card Bottom)

6. Power Group:

Table 6.1 shows the MXM module power requirements. The voltage tolerances in the table are specified as measured on module edge finger. The system must be able to supply the full specified current on rails (except PWR_SRC) at all times. The current capability of the PWR_SRC rail must be defined by the system in the MXM system information structure.

Table 6.1: MXM Power Rails

Signal Name	I/O	Type	Impedance	Voltage	Current
PWR_SRC	I	Power	N/A	12-19V	up to 10A
5V	I	Power	N/A	5.0V \pm 6%	2.5A
3.3V	I	Power	N/A	3.3V \pm 6%	2.0A

Note: PWR_SRC voltage range is assumed to be DC or RMS. However under any circumstances the maximum peak voltage shall not exceed 22V and minimum voltage shall not fall below 6.5V.

7. Power Sequencing:

There is no power sequencing requirement for the input voltages to the MXM module. However the PWR_EN signal may be asserted only after all power rails are within specified tolerance. The state of PWR_GOOD is undefined until all rails are fully ramped. Refer to Figure 7.1 for details

Figure 7.1 Power Sequencing

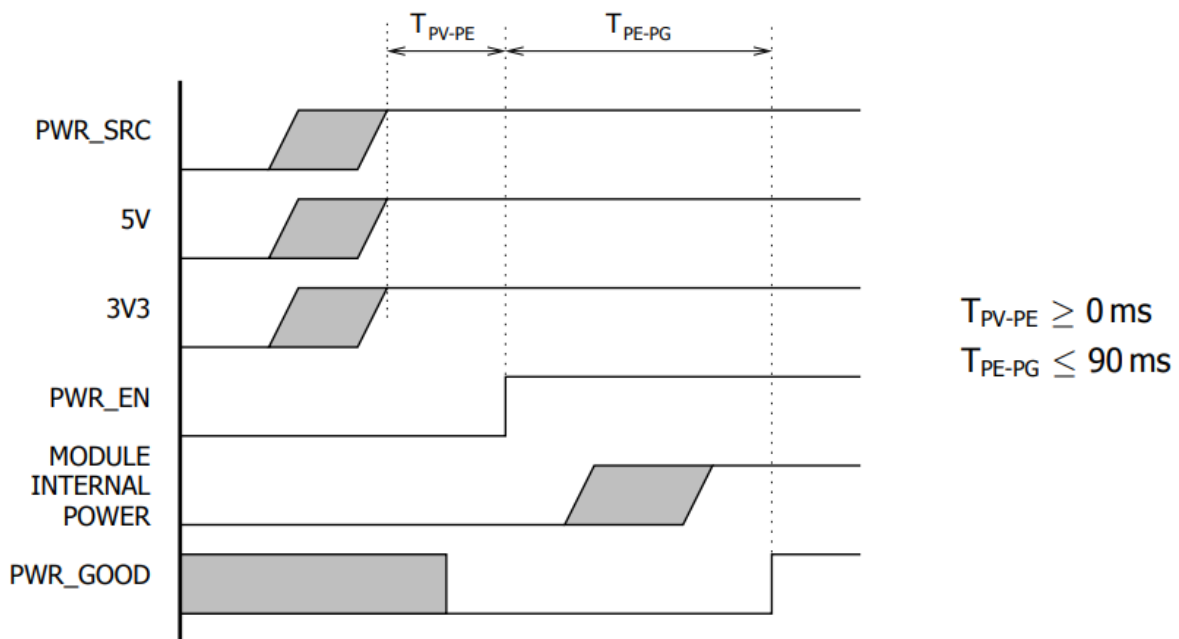

8. Module Power Down and Power Up:

The MXM module may be powered down using the PWR_EN signal. The system designer may choose to shut down or keep the input power while the module is powered down. Refer to Figure 8.1 for details.

Figure 8.1 Module Power Down

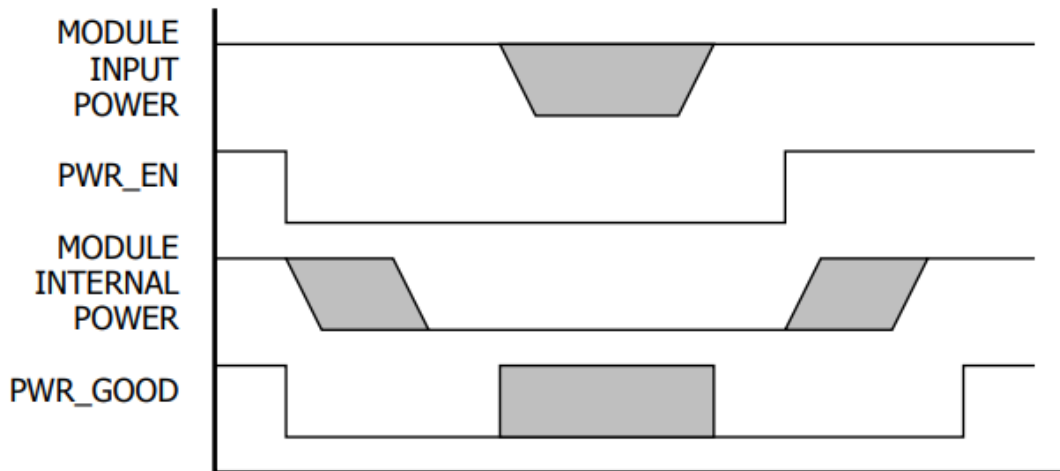

9. Reset Requirements:

System reset may be deasserted only after the assertion of the PWR_GOOD signal. Figure 9.1 shows the reset requirements relative to the PWR_EN and PWR_GOOD signals. This sequence must be followed on initial power on, system reset and resume from suspend/hibernate.

Figure 9.1 Reset Sequencing

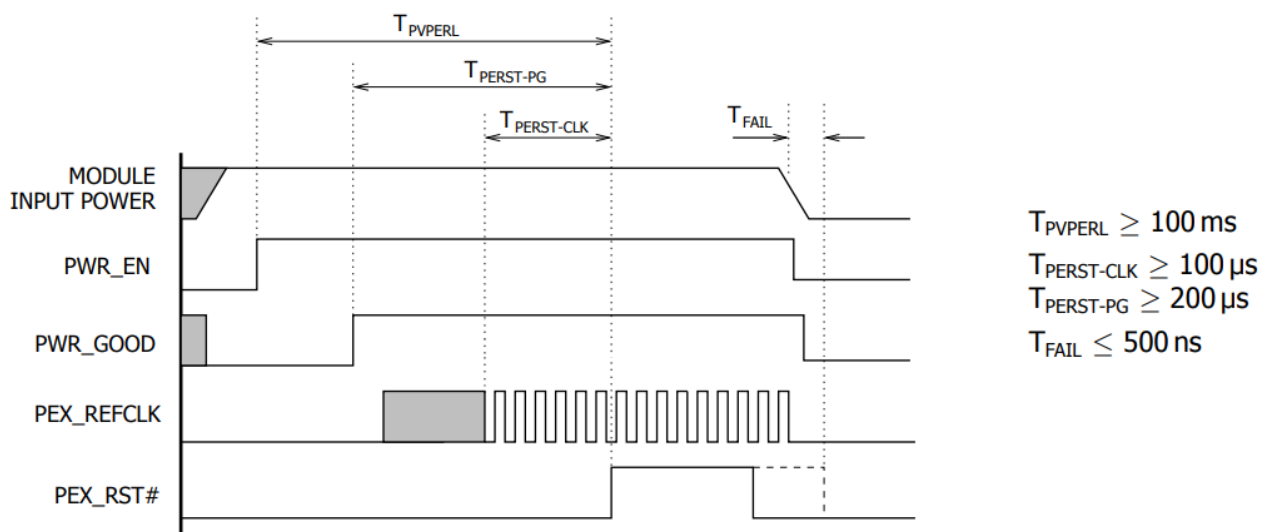

10.DisplayPort Interface:

DC blocking capacitors of DisplayPort must be placed on the system board. In addition to the MXM implementation of Dual-mode DisplayPort requires the circuit in Figure 10.1 on the AUX lines for proper dongle detection. The HPD signal conditioning must also be placed on the system board.

Figure 10.1 Dual-mode DisplayPort Implementation

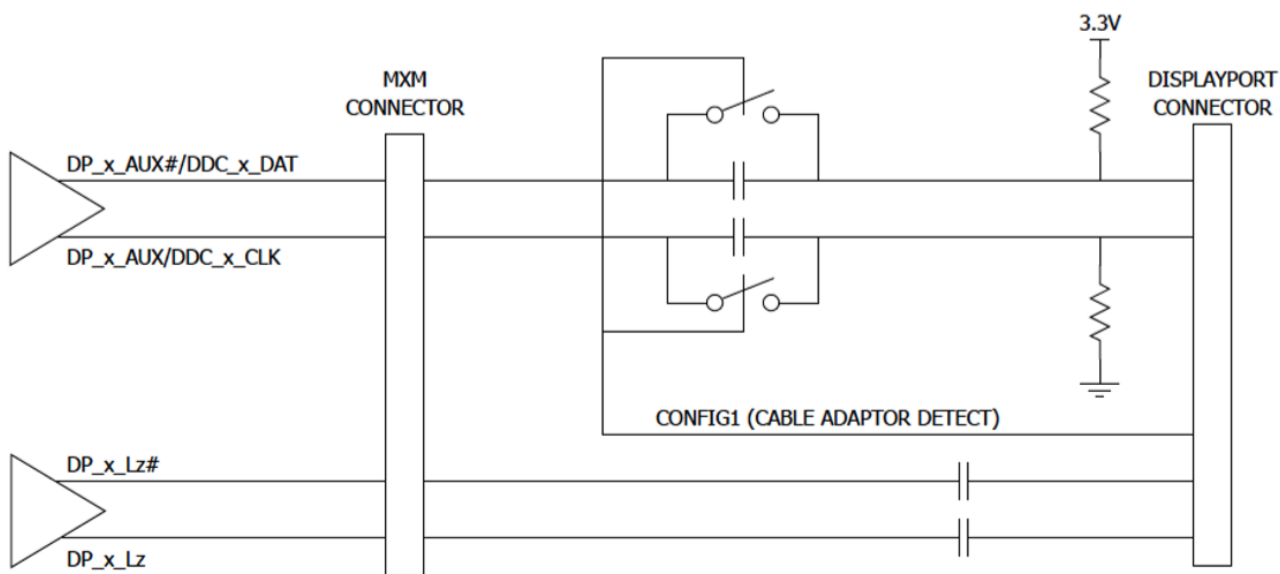

11. Thermal:

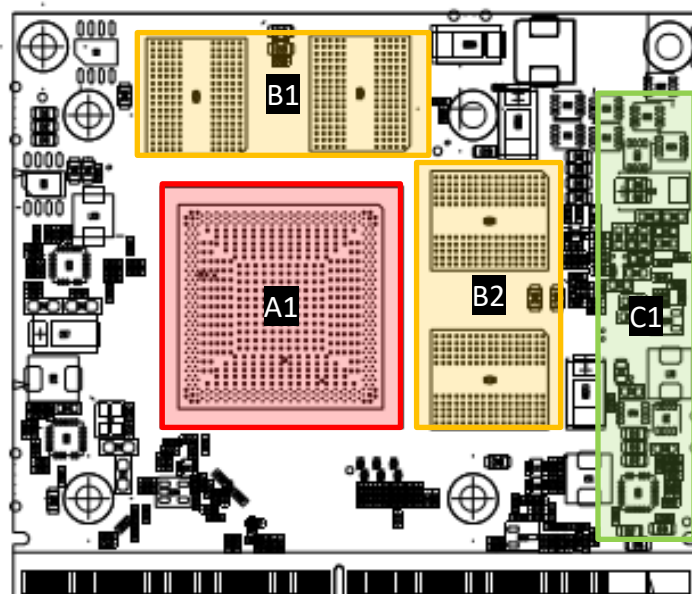

Components	Area	TDP	Height
GPU	A1	61W	1.8mm
Memory	B1	1.5W*2	0.9mm
Memory	B2	1.5W*2	0.9mm
Mosfet	C1	2W*4	0.75mm

Chipset		Specification
Dimensions		11.5*12.1mm
Stress	Maximum	75 PSI
	Normal	30-40 PSI

Cooling Suggestion:

- 1、显卡建议先固定在散热器上，散热器外径为 4mm，M2 的螺柱。
- 2、散热器的重量要用箱体来支撑固定。
- 3、显存和 MOS 要加导热垫。

Components	亮温满载限温（环温 45℃）
GPU	95℃
Memory	85℃
Mosfet	105℃

*显存和 MOS 由“探针”监测；GPU 由“Furmark (1920*1080)”监测。

12.Performance:

3Dmark13 FS	6800	Cuda	
3Dmark11	E8589 P6821 X2962	single kernels	1785.5 / 65.0026
3Dmark Vantage	29823	N=10 w/o streams	1851.34 / 65.8818
Heaven	2711	N=10 with streams	1881.4 / 66.1985
鲁大师	81544	N=10 batched	2063.9 / 65.6442

SPECviewperf 13 1900x1060			
3dsmax-06	61.26	medical-02	38.61
catia-05	99.16	showcase-02	26.93
creo-02	78.59	snx-03	106.91
energy-02	12.27	sw-04	94.71
maya-05	88.53		

13.Driver:

Windows 11: https://cn.download.nvidia.com/Windows/Quadro_Certified/552.74/552.74-quadro-rtx-desktop-notebook-win10-win11-64bit-international-dch-whql.exe

Windows 10 64bit: https://cn.download.nvidia.com/Windows/Quadro_Certified/552.74/552.74-quadro-rtx-desktop-notebook-win10-win11-64bit-international-dch-whql.exe

Windows 10 32bit: https://cn.download.nvidia.com/Windows/Quadro_Certified/392.37/392.37-quadro-desktop-notebook-win10-32bit-international-whql.exe

Linux aarch64 : <https://cn.download.nvidia.com/XFree86/aarch64/560.28.03/NVIDIA-Linux-aarch64-560.28.03.run>

Linux 64bit: https://cn.download.nvidia.com/XFree86/Linux-x86_64/450.80.02/NVIDIA-Linux-x86_64-450.80.02.run

Linux 32bit: <https://cn.download.nvidia.com/XFree86/Linux-x86/390.157/NVIDIA-Linux-x86-390.157.run>

Linux 32bit ARM: <https://cn.download.nvidia.com/XFree86/Linux-x86-ARM/390.157/NVIDIA-Linux-armv7l-gnueabi-390.157.run>

Solaris x86/x64: <https://cn.download.nvidia.com/solaris/560.28.03/NVIDIA-Solaris-x86-560.28.03.run>

FreeBSD x86: <https://cn.download.nvidia.com/XFree86/FreeBSD-x86/390.157/NVIDIA-FreeBSD-x86-390.157.tar.gz>

FreeBSD x64: https://cn.download.nvidia.com/XFree86/FreeBSD-x86_64/560.28.03/NVIDIA-FreeBSD-x86_64-560.28.03.tar.xz

The latest drive or the drive cannot be downloaded here, please log on the official website to download: <https://www.nvidia.cn/geforce/drivers/>

14. Dimensions:

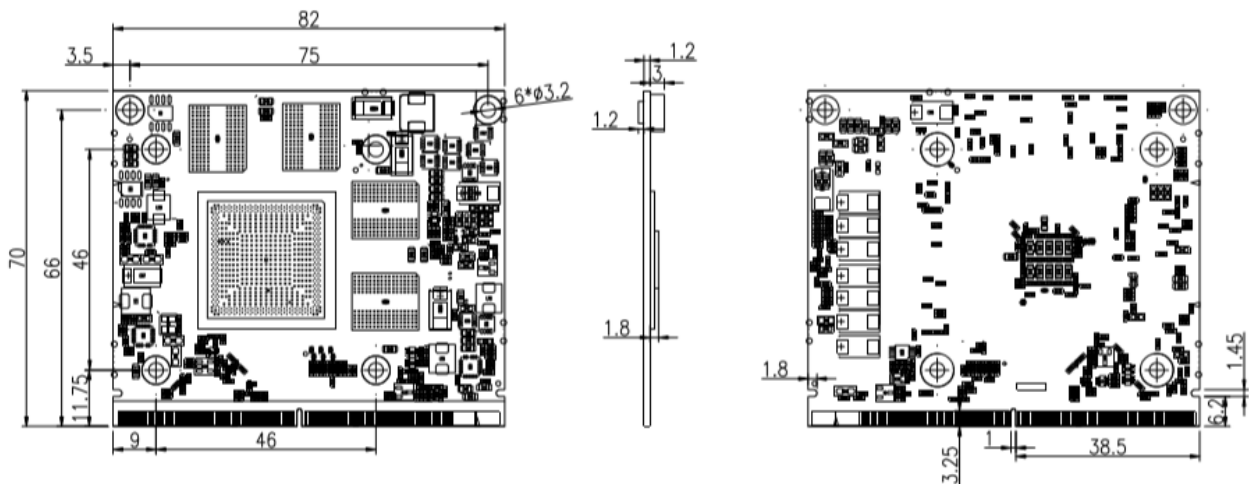

15.Photo:

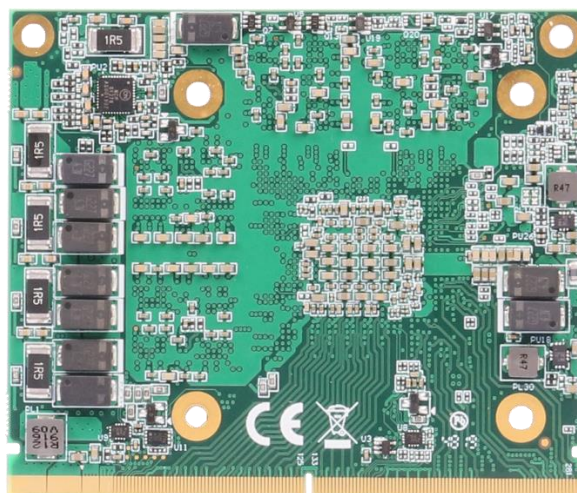
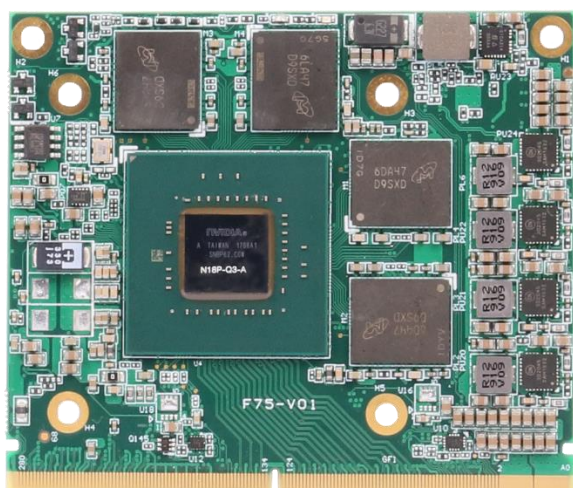

16.Cooling Option:

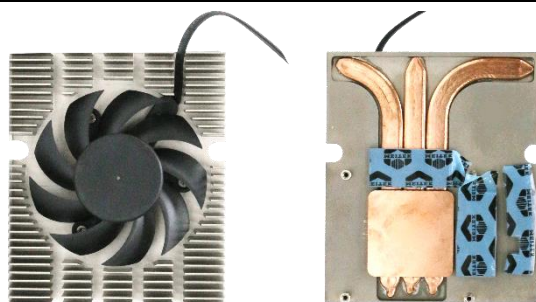

1.ZRT.48-6209-00-A00	
Dimension	96*80.2*25mm
Rated Speed	4500
Out of Frame Lead Wires	150mm
Connector	4Pin 2.54

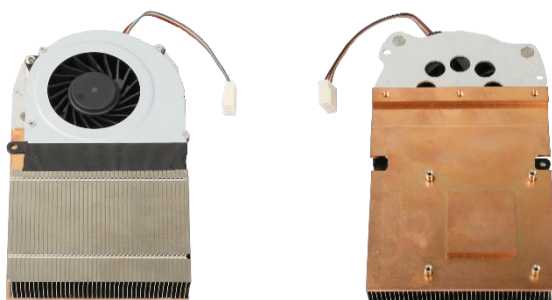

1.ZRT.48-6171-00-A00	
Dimension	137.5*83*21mm
Rated Speed	3600
Out of Frame Lead Wires	220mm
Connector	4Pin 2.54

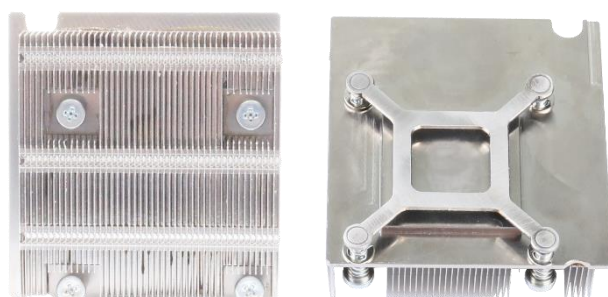

1.ZRT.48-6197-00-A00	
Dimension	75.5*71*22.5mm
Rated Speed	N/A
Out of Frame Lead Wires	N/A
Connector	N/A

*需搭配风扇辅助散热。

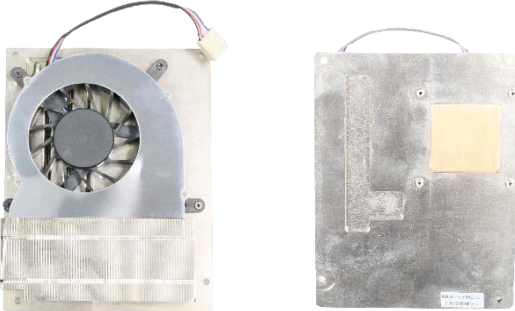
	1.ZRT.48-6140-00-A00	
	Dimension	133*103*26.5mm
Rated Speed	3800	
Out of Frame Lead Wires	100mm	
Connector	4Pin 2.54	

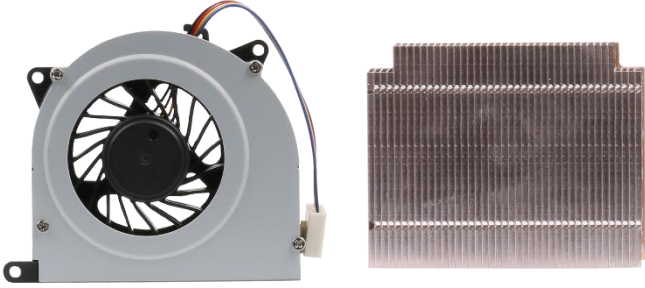
	1.ZRT.48-6111-00-A00 1.ZRT.48-6153-00-A00	
	Dimension	Heat Sink 82*65.5*21mm Fan 75*75*15mm
Rated Speed	3600	
Out of Frame Lead Wires	80mm	
Connector	4Pin 2.54	

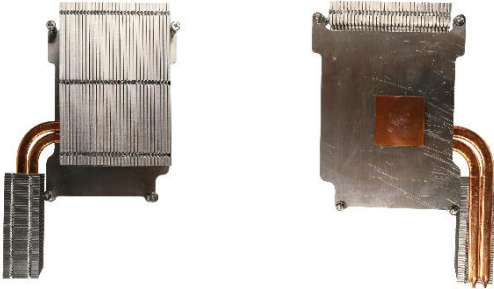
	1.ZRT.30-6430-00-A00	
	Dimension	190*124.5*37.5mm
Rated Speed	N/A	
Out of Frame Lead Wires	N/A	
Connector	N/A	

*需搭配风扇辅助散热。

17.Question:

故障	排除
不开机	1、更改 pgood 信号。(部份主板) 2、确认 PCIE 复位信号。 3、主板 BIOS 更改为 UEFI BIOS。
不显示	Windows 10 : (需 1809 版本之后) 在主板 BIOS 下, 将 CSM 中 CSM Support 设置由 Enabled 更改为 Disabled。 Windows7 : 在主板 BIOS 下, 将 CSM 中 CSM Support 设置由 Enabled 更改为

	Disabled，并将 Video 设置由 legacy 更改为 UEFI。
不显示（HDMI 输出）	1、4K 60Hz 显示屏，确认 HDMI 线材是否为 HDMI2.0。 2、将显示器分辨率降为 2K 60Hz。
设备管理员出现惊叹号	1、原系统显卡驱动删除干净。（请使用 Display Driver Uninstaller 删除， https://www.wagnardsoft.com/ ） 2、Windows 10 版本 16299 不支持，需更新至最新版（17763、17134 均可）。 3、Windows 7 打补丁 KB2685811。 4、确认核显驱动是否已安装。（不需独立显卡显示）
显卡不工作	量下 3V3/5V/2V/Reset 信号是否有电/短路？若有电，显卡就会工作。
显卡无法辨视	检查 PCIE LANE Numbering Reversal 设置。
安装 Linux 系统，图形界面异常/无限循环登陆界面，无法登录系统	装驱动的时，加上--no-opengl-files。 （禁用 opengl，若系统上有用到这套组件，将无法使用）
控制面板无法正常开启	仅可在独显显示时，才能正常开启；若使用集显显示，将无法正常开启。
集显及独显在 Win7 下，无法同时开启 3D 启动	打系统补丁（KB2685811），解压后，把所有文件 COPY 到 C 盘 根目录下运行 BAT 文件。

18.Part Number:

Model	Part Number	Specification
MMP2000A5-4G	8.ZRT.80-6449-00-LFF	F75 P2000 4G 128bit GDDR5 256*32 4DP MXM Type A-工包六十八
	8.ZRT.80-6449-01-LFF	F75 P2000m 4G 128bit GDDR5 4DP MXM Type A 75W/-40 度-ZRT 彩包二十八