



# MMP3000B5-6G

MXM 显卡

USER' Manual V1.0

## USER'S MANUAL 用户手册

## 声明

本使用说明书内容如有变更，恕不另行通知。本公司并不对本使用说明书之适用性，适合做某种特殊用途之使用或其他任何事项做任何明示，或做其他形式之保证或担保。因此本公司将不对手册内容之错误，或因增减展示或以其他方法使用本手册所造成之直接，间接，突发性过、或继发性之损害负任何责任。

版权声明：

版权所有----深圳智锐通科技有限公司。未经本公司许可或依著作权法之规定许准，不得复制，节录和翻译使用说明书之任何内容。

## 安全须知

1	产品使用前，务必仔细阅读产品说明书。
2	对未准备安装的板卡，应将其保存在防静电保护袋中。
3	在从包装袋中拿板卡前，应将手先置于接地金属物体上一会儿，以释放身体及手中的静电。
4	在拿板卡时，需佩带静电保护手套，并且应该养成只触及其边缘部份的习惯。
5	主板与电源连接时，请确认电源电压。
6	为避免人本被电击或产品被损坏，在每次对主板、板卡进行拔插或生新配置时须先关闭交流电源或将交流电源线从电源插座中拔掉。
7	在对板卡进行搬动前，先将交流电源线从电源插座中拔掉。
8	当您需连接或拔除任何设备前，须确定所有的电源线事先已被拔掉。
9	为避免频繁开关机对产品造成不必要的损伤,关机后,应至少等待30秒后再开机。
10	设备在使用过程时出现异常情况，请找专业人员处理。

# 目录

1.Specifications.....	5
2.Block Diagram .....	7
3.MXM Board Outlines .....	8
4.MXM PCB Mounting Holes.....	10
5.Connector Pinout .....	11
6.MXM Connector .....	13
7.Power Group .....	13
8.Power Sequencing .....	14
9.Module Power Down and Power Up.....	14
10.Reset Requirements.....	15
11.DisplayPort Interface.....	15
12.Thermal .....	16
13.Install Video .....	16
14.Performance .....	17
15.Driver.....	18
16.Dimensions .....	18
17.Photo.....	19
18.Cooling Option .....	19
19.Question.....	19
20.Part Number .....	20
21.Label .....	21

## 1.Specifications

Model	MMP3000B5-6G
<b>GPU Architecture</b>	NVIDIA Pascal
<b>Graphics Processing Unit</b>	NVIDIA Quadro P3000 Mobility
<b>Bus Type</b>	MXM3 .1 / up to PCI Express 3.0 x16
<b>Graphics Clock</b>	1088MHz / 1215MHz (Boost)
<b>Memory Size</b>	6GB 192bit GDDR5
<b>Memory Clock</b>	1752MHz (7.0 Gbps)
<b>Memory Bandwidth</b>	168.2GB/s
<b>Display Features</b>	DP A: Display Port 1.4++ DP B: Display Port 1.4++ DP C: Display Port 1.4++ DP D: Display Port 1.4
<b>Single Max Resolution</b>	7680x4320@120Hz
<b>Number of Output Channel</b>	4
<b>Board Power</b>	87W
<b>Board Dimensions</b>	MXM Graphics Module Version 3.1 Type B (105x82mm)
<b>Operation System</b>	Windows 7/8/8.1/10 64bit · Linux 64bit
<b>VIN Range</b>	DC 12~19V, 3.3V & 5V; +/-5%
<b>Operating Temperature</b>	0~45°C
<b>Storage Temperature</b>	-20~75°C
<b>Operating Humidity</b>	0~95% (non-condensing)
<b>Storage Humidity</b>	10~90%

Render Config	
<b>Shader Processing Units</b>	1280
<b>TMUs</b>	80
<b>ROPs</b>	48
<b>SM Count</b>	10
<b>L1 Cache</b>	48KB (per SM)
<b>L2 Cache</b>	1536KB

Theoretical Performance	
<b>Pixel Rate</b>	58.32GPixel/s
<b>Texture Rate</b>	97.20GTexel/s
<b>Single Precision FLOPS(AIDA64)</b>	2908GFLOPS
<b>Double Precision FLOPS(AIDA64)</b>	96.52GFLOPS

Graphics Features	
<b>DirectX</b>	12 Ultimate (12_1)
<b>OpenGL</b>	4.6
<b>OpenCL</b>	3.0
<b>Vulkan</b>	1.3
<b>Shader Model</b>	6.7
<b>CUDA</b>	6.1
<b>Video Playback</b>	H.265, VC1, MPEG2 1080P

Surround(Landscape)	Surround(Portrait)
2x1(3840x1080@60Hz)	2x1(2160x1920@60Hz)
1x2(1920x2160@60Hz)	1x2(1080x3840@60Hz)
3x1(5760x1080@60Hz)	3x1(3240x1920@60Hz)
1x3(1920x3240@60Hz)	1x3(1080x5760@60Hz)
4x1(7680x1080@60Hz)	4x1(1080x7680@60Hz)
1x4(7680x1080@60Hz)	1x4(1080x7680@60Hz)
2x2(3840x2160@60Hz)	2x2(2160x3840@60Hz)

*\*Total resolution based on every display resolution is 1920\*1080@60Hz.*

## 2. Block Diagram

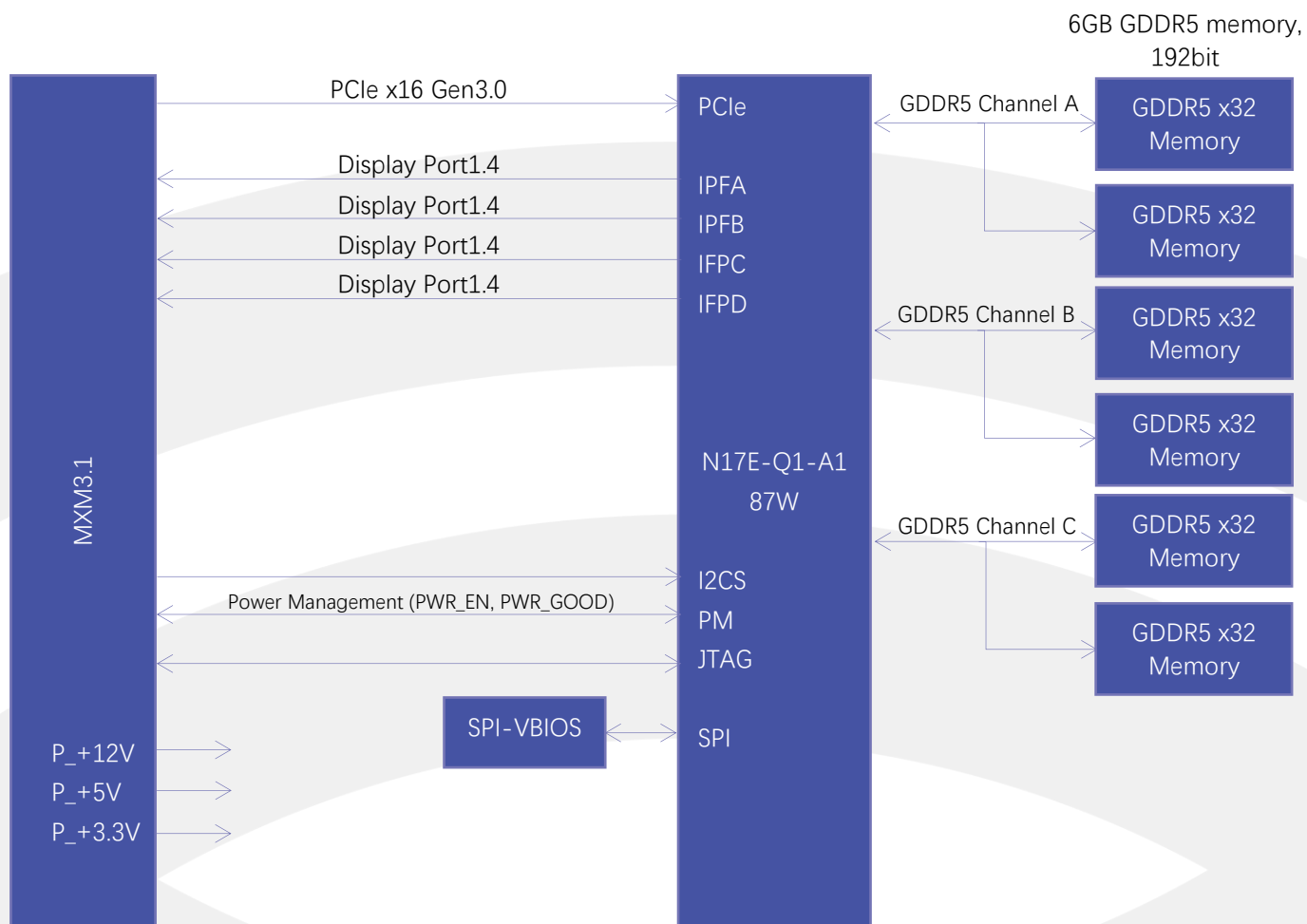

### 3.MXM Board Outlines

Figure 3.1 shows the board outlines (top side view) for Type B MXM modules. An additional system keep-out of 0.5mm[0.020] per side is allowed on the PCB to accommodate whatever means of production panelization is required. This additional clearance is above and beyond the dimensional limits presented here. The location of these features is not specified or controlled.

Figure 3.1 Board Outlines

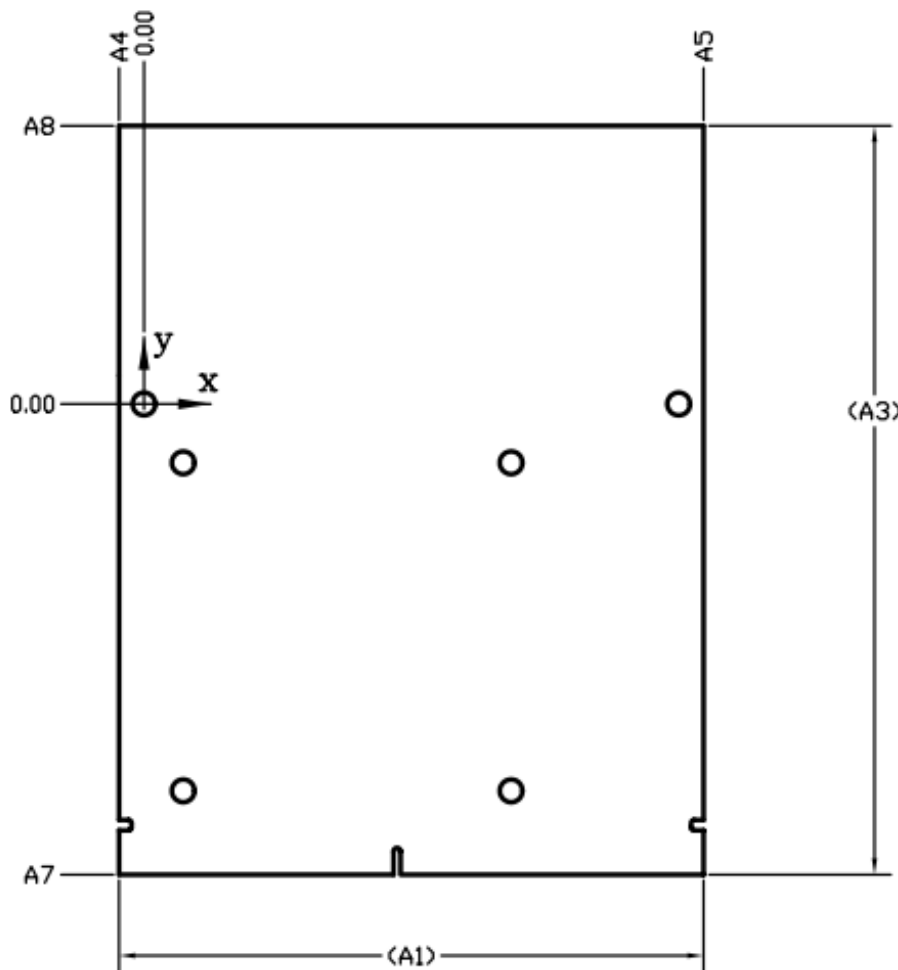

## TYPE B

Table 3.1 Board Outline Dimensions

Symbol	[mm]			[in]		
	min	nom	max	min	nom	max
A1		82.00			3.228	
A3		105.00			4.134	
A4	3.37	3.50	3.63	0.133	0.138	0.143
A5	78.37	78.50	78.63	3.085	3.091	3.096
A7	65.87	66.00	66.13	2.593	2.598	2.604
A8	38.87	39.00	39.13	1.530	1.535	1.541

Figure 3.2 Board Slots Detail



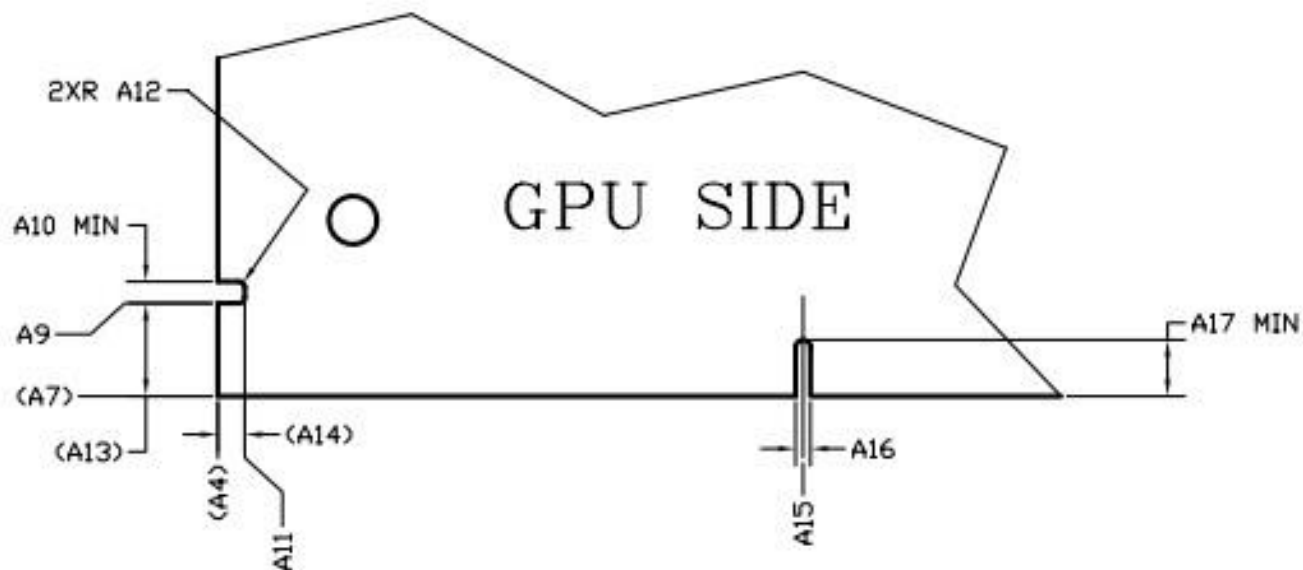

Table 3.2 Board Slots Dimensions

Symbol	[mm]			[in]		
	min	nom	max	min	nom	max
A4		3.50			0.138	
A7		66.00			2.598	
A9	59.67	59.80	59.93	2.349	2.354	2.359
A10	1.45			0.057		
A11	1.57	1.70	1.83	0.062	0.067	0.072
A12	0.32	0.50	0.58	0.013	0.020	0.023
A13		6.20			0.244	
A14		1.80			0.071	
A15	35.37	35.50	35.63	1.393	1.398	1.403
A16	0.95	1.00	1.05	0.037	0.039	0.041
A17	3.75			0.148		

## 4.MXM PCB Mounting Holes

All MXM version 3.1 modules have 6 holes. Two are used to secure the board to the system and the other four to fasten the thermal solution to the module.

Figure 4.1 Mounting Holes

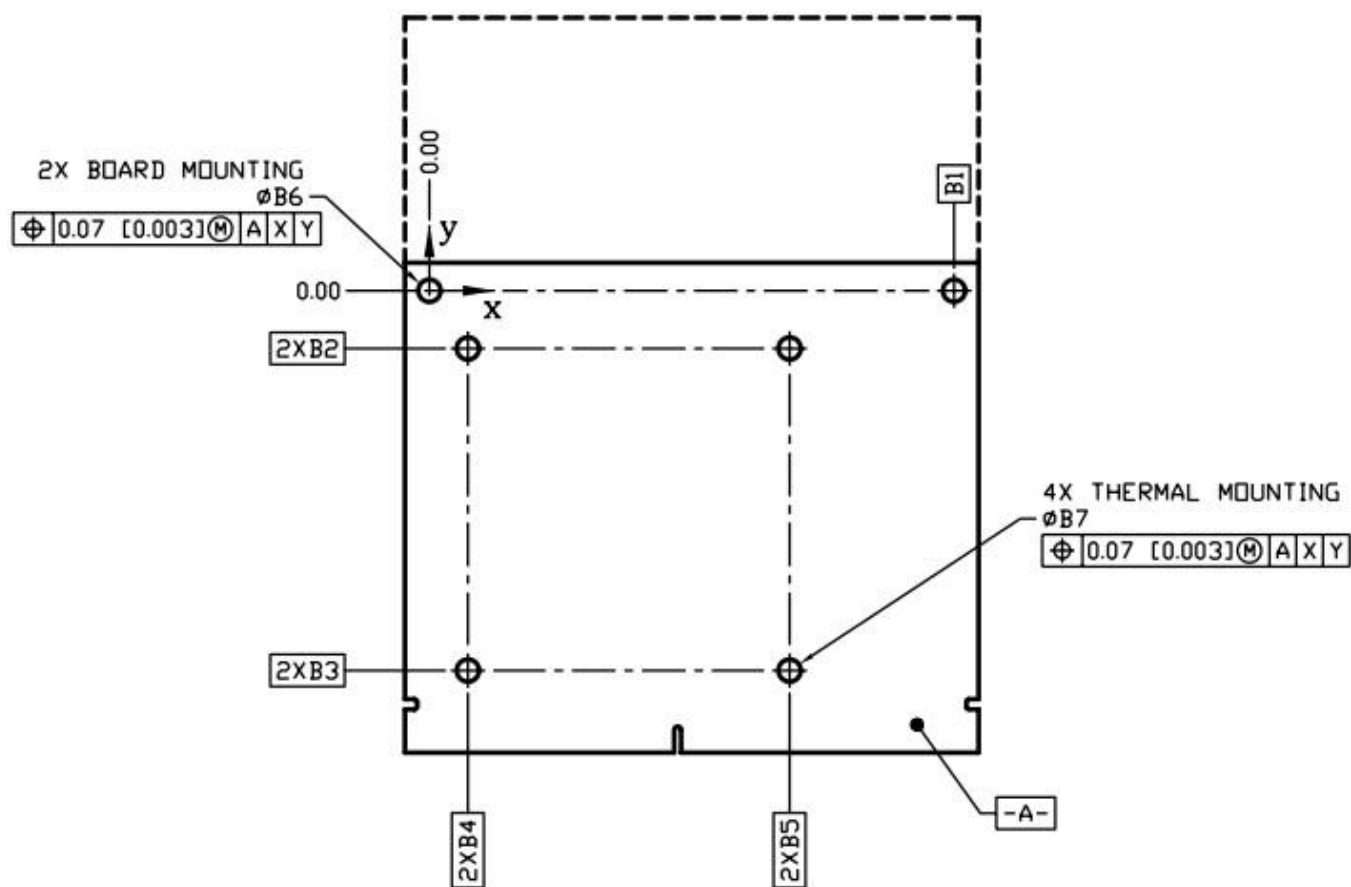

Table 4.1 Mounting Holes Dimensions

Symbol	[mm]			[in]		
	min	nom	max	min	nom	max
B1		75.00			2.953	
B2		8.25			0.325	
B3		54.25			2.136	
B4		5.50			0.217	
B5		51.50			2.028	
B6	3.07	3.20	3.33	0.121	0.126	0.131
B7	3.07	3.20	3.33	0.121	0.126	0.131

## 5.Connector Pinout

Table 5.1 and Table 5.2 list the connector pinout.

Table 5.1 Connector Pinout

Pin	Signal Name	Pin	Signal Name	Pin	Signal Name	Pin	Signal Name
E1	PWR_SRC	E2	PWR_SRC	69	PEX_RX12	70	GND
E3	GND	E4	GND	71	GND	72	PEX_TX11#
1	5V	2	PRSNT_R#	73	PEX_RX11#	74	PEX_TX11
3	5V	4	WAKE#	75	PEX_RX11	76	GND
5	5V	6	PWR_GOOD	77	GND	78	PEX_TX10#
7	5V	8	PWR_EN	79	PEX_RX10#	80	PEX_TX10
9	5V	10	27MHZ_REF	81	PEX_RX10	82	GND
11	GND	12	GND	83	GND	84	PEX_TX9#
13	GND	14	LVDS_U_HPD	85	PEX_RX9#	86	PEX_TX9
15	GND	16	JTAG_TESTEN	87	PEX_RX9	88	GND
17	GND	18	PWR_LEVEL	89	GND	90	PEX_TX8#
19	PEX_STD_SW#	20	TH_OVERT#	91	PEX_RX8#	92	PEX_TX8
21	VGA_DISABLE #	22	TH_ALERT#	93	PEX_RX8	94	GND
23	N/A	24	TH_PWM	95	GND	96	PEX_TX7#
25	N/A	26	GPIO0	97	PEX_RX7#	98	PEX_TX7
27	N/A	28	GPIO1	99	PEX_RX7	100	GND
29	HDMI_CEC	30	GPIO2	101	GND	102	PEX_TX6#
31	LVDS_L_HPD	32	SMB_DAT	103	PEX_RX6#	104	PEX_TX6
33	LVDS_DDC_D AT	34	SMB_CLK	105	PEX_RX6	106	GND
35	LVDS_DDC_CL K	36	GND	107	GND	108	PEX_TX5#
37	GND	38	OEM0	109	PEX_RX5#	110	PEX_TX5
39	OEM1	40	OEM2	111	PEX_RX5	112	GND
41	OEM3	42	OEM4	113	GND	114	PEX_TX4#
43	OEM5	44	OEM6	115	PEX_RX4#	116	PEX_TX4
45	OEM7	46	GND	117	PEX_RX4	118	GND
47	GND	48	PEX_TX15#	119	GND	120	PEX_TX3#
49	PEX_RX15#	50	PEX_TX15	121	PEX_RX3#	122	PEX_TX3
51	PEX_RX15	52	GND	123	PEX_RX3	124	GND
53	GND	54	PEX_TX14#	125	GND	126	KEY
55	PEX_RX14#	56	PEX_TX14	127	KEY	128	KEY
57	PEX_RX14	58	GND	129	KEY	130	KEY
59	GND	60	PEX_TX13#	131	KEY	132	KEY
61	PEX_RX13#	62	PEX_TX13	133	GND	134	GND
63	PEX_RX13	64	GND	135	PEX_RX2#	136	PEX_TX2#
65	GND	66	PEX_TX12#	137	PEX_RX2	138	PEX_TX2
67	PEX_RX12#	68	PEX_TX12	139	GND	140	GND

Table 5.2 Connector Pinout(continued)

Pin	Signal Name	Pin	Signal Name	Pin	Signal Name	Pin	Signal Name
141	PEX_RX1#	142	PEX_TX1#	213	DP_C_L2	214	DP_D_L1
143	PEX_RX1	144	PEX_TX1	215	GND	216	GND
145	GND	146	GND	217	DP_C_L3#	218	DP_D_L2#
147	PEX_RX0#	148	PEX_TX0#	219	DP_C_L3	220	DP_D_L2
149	PEX_RX0	150	PEX_TX0	221	GND	222	GND
151	GND	152	GND	223	DP_C_AUX#	224	DP_D_L3#
153	PEX_REFCLK#	154	PEX_CLK_REQ#	225	DP_C_AUX	226	DP_D_L3
155	PEX_REFCLK	156	PEX_RST#	227	RSVD	228	GND
157	GND	158	VGA_DDC_DATA	229	RSVD	230	DP_D_AUX#
159	JTAG_TDO	160	VGA_DDC_CLOCK	231	RSVD	232	DP_D_AUX
161	JTAG_TDI	162	VGA_VSYNC	233	RSVD	234	DP_C_HPD
163	JTAG_TCLK	164	VGA_HSYNC	235	RSVD	236	DP_D_HPD
165	JTAG_TMS	166	GND	237	RSVD	238	RSVD
167	JTAG_TRST#	168	VGA_RED	239	RSVD	240	3V3
169	LVDS_UCLK#	170	VGA_GREEN	241	RSVD	242	3V3
171	LVDS_UCLK	172	VGA_BLUE	243	RSVD	244	GND
173	GND	174	GND	245	RSVD	246	DP_B_L0#
175	LVDS_UTX3#	176	LVDS_LCLK#	247	RSVD	248	DP_B_L0
177	LVDS_UTX3	178	LVDS_LCLK	249	RSVD	250	GND
179	GND	180	GND	251	GND	252	DP_B_L1#
181	LVDS_UTX2#	182	LVDS_LTX3#	253	DP_A_L0#	254	DP_B_L1
183	LVDS_UTX2	184	LVDS_LTX3	255	DP_A_L0	256	GND
185	GND	186	GND	257	GND	258	DP_B_L2#
187	LVDS_UTX1#	188	LVDS_LTX2#	259	DP_A_L1#	260	DP_B_L2
189	LVDS_UTX1	190	LVDS_LTX2	261	DP_A_L1	262	GND
191	GND	192	GND	263	GND	264	DP_B_L3#
193	LVDS_UTX0#	194	LVDS_LTX1#	265	DP_A_L2#	266	DP_B_L3
195	LVDS_UTX0	196	LVDS_LTX1	267	DP_A_L2	268	GND
197	GND	198	GND	269	GND	270	DP_B_AUX#
199	DP_C_L0#	200	LVDS_LTX0#	271	DP_A_L3#	272	DP_B_AUX
201	DP_C_L0	202	LVDS_LTX0	273	DP_A_L3	274	DP_B_HPD
203	GND	204	GND	275	GND	276	DP_A_HPD
205	DP_C_L1#	206	DP_D_L0#	277	DP_A_AUX#	278	3V3
207	DP_C_L1	208	DP_D_L0	279	DP_A_AUX	280	3V3
209	GND	210	GND	281	PRSNT_L#	-	
211	DP_C_L2#	212	DP_D_L1#				

## 6.MXM Connector

Figure 6.1 MXM Connector (Card Top)

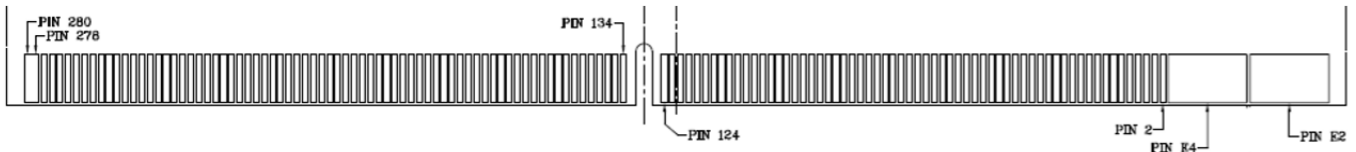
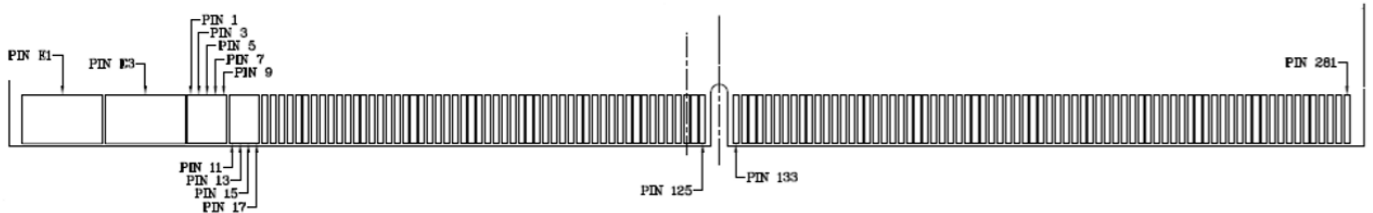

Figure 6.2 MXM Connector (Card Bottom)



## 7.Power Group

Table 7.1 shows the MXM module power requirements. The voltage tolerances in the table are specified as measured on module edge finger. The system must be able to supply the full specified current on rails (except PWR\_SRC) at all times. The current capability of the PWR\_SRC rail must be defined by the system in the MXM system information structure.

Table 7.1 MXM Power Rails

Signal Name	I/O	Type	Impedance	Voltage	Current
PWR_SRC	I	Power	N/A	12-19V	up to 10A
5V	I	Power	N/A	5.0V $\pm$ 6%	2.5A
3.3V	I	Power	N/A	3.3V $\pm$ 6%	2.0A

*Note: PWR\_SRC voltage range is assumed to be DC or RMS. However under any circumstances the maximum peak voltage shall not exceed 22V and minimum voltage shall not fall below 6.5V.*

## 8. Power Sequencing

There is no power sequencing requirement for the input voltages to the MXM module. However the PWR\_EN signal may be asserted only after all power rails are within specified tolerance. The state of PWR\_GOOD is undefined until all rails are fully ramped. Refer to Figure 8.1 for details

Figure 8.1 Power Sequencing

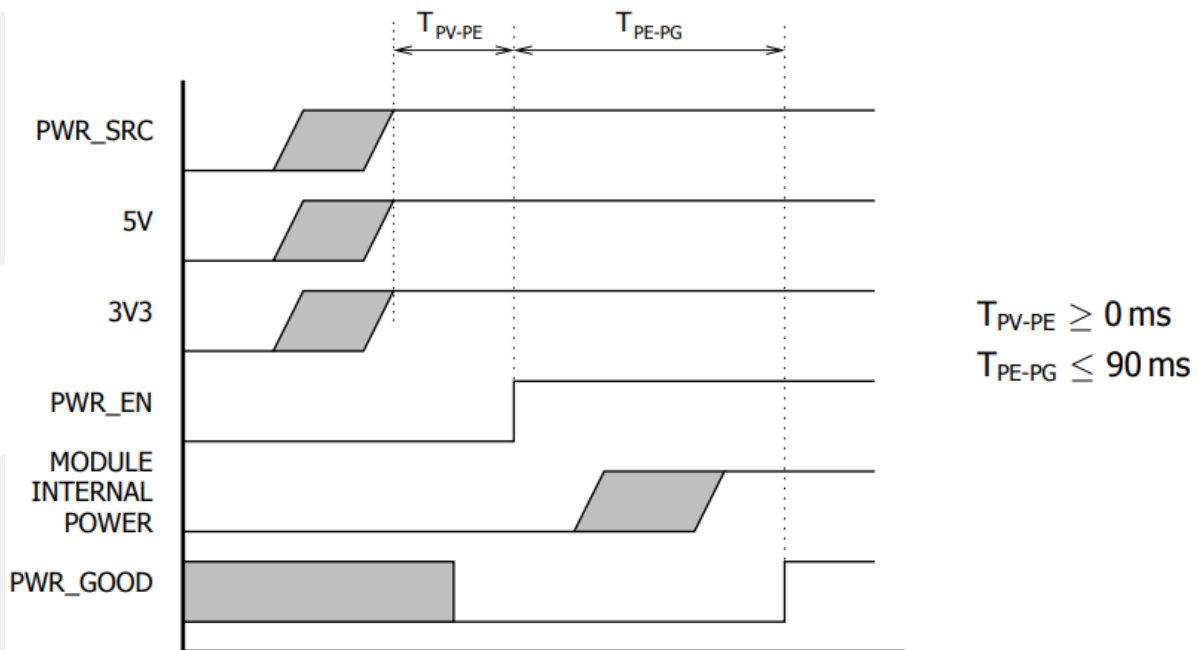

## 9. Module Power Down and Power Up

The MXM module may be powered down using the PWR\_EN signal. The system designer may choose to shut down or keep the input power while the module is powered down. Refer to Figure 9.1 for details.

Figure 9.1 Module Power Down

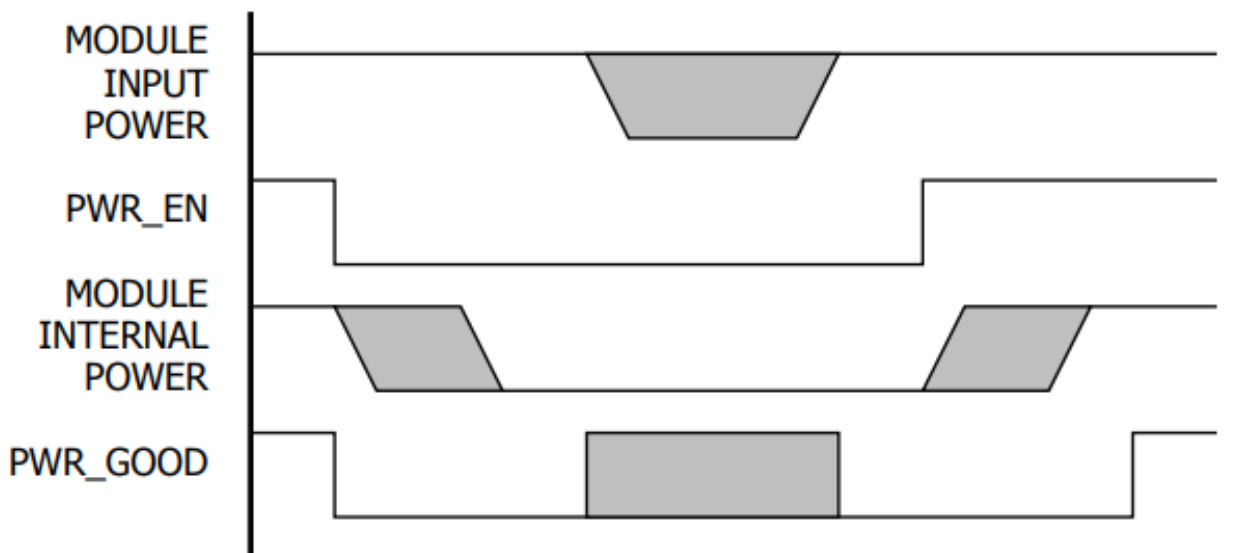

## 10.Reset Requirements

System reset may be deasserted only after the assertion of the PWR\_GOOD signal. Figure 10.1 shows the reset requirements relative to the PWR\_EN and PWR\_GOOD signals. This sequence must be followed on initial power on, system reset and resume from suspend/hibernate.

Figure 10.1 Reset Sequencing

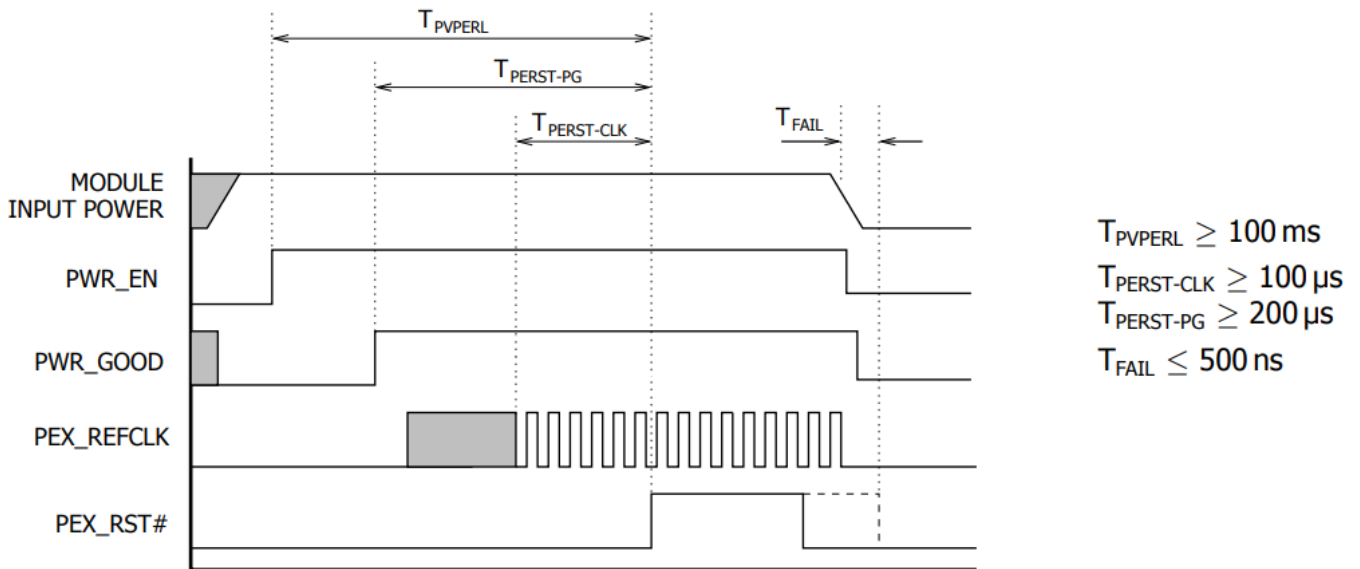

## 11.DisplayPort Interface

DC blocking capacitors of DisplayPort must be placed on the system board. In addition to the MXM implementation of Dual-mode DisplayPort requires the circuit in Figure 11.1 on the AUX lines for proper dongle detection. The HPD signal conditioning must also be placed on the system board.

Figure 11.1 Dual-mode DisplayPort Implementation

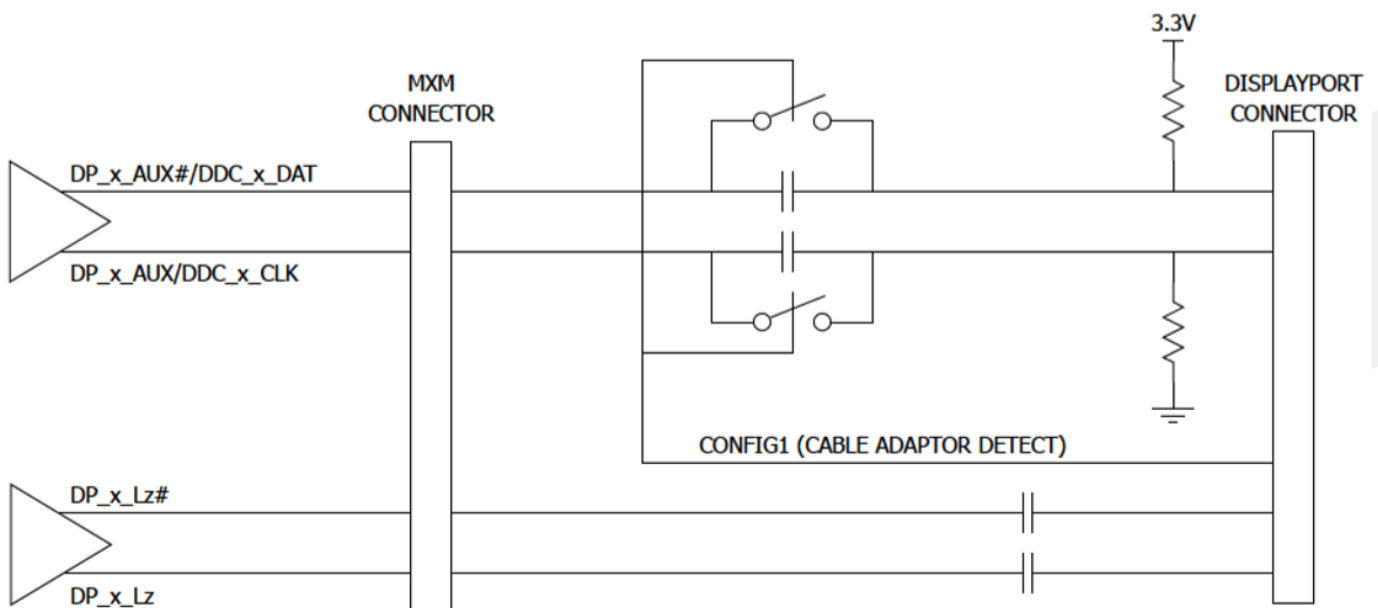

## 12.Thermal

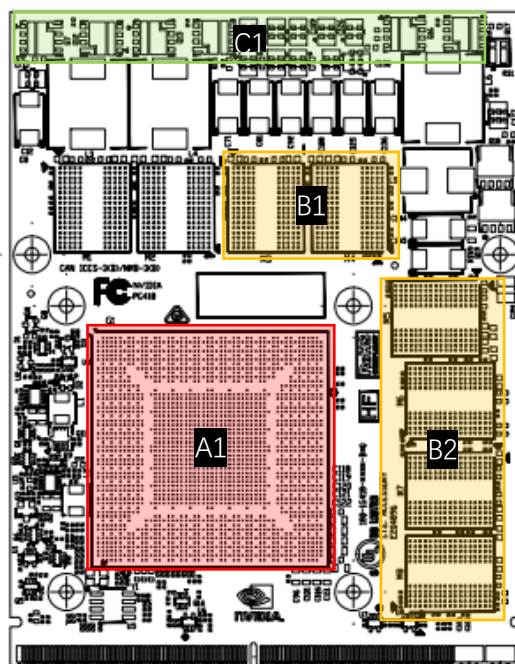

Components	Area	TDP	Height
GPU	A1	66W	2.3mm
Memory	B1	1.5W*2	0.9mm
Memory	B2	1.5W*4	0.9mm
Mosfet	C1	2W*6	0.75mm

Chipset		Specification
Dimensions		17*20*2.3mm
Stress	Maximum	75 PSI
	Normal	30-40 PSI

### Cooling Suggestion:

- 1、显卡建议先固定在散热器上，散热器外径为 4mm，M2 的螺柱。
- 2、散热器的重量要用箱体来支撑固定。
- 3、显存和 MOS 要加导热垫。

Components	壳温满载限温 (环温 45°C)
GPU	95°C
Memory	85°C
Mosfet	105°C

\*显存和 MOS 由“探针”监测；GPU 由“Furmark (1920\*1080)”监测。

## 13.Install Video

[https://www.douyin.com/user/MS4wLjABAAAfv567McP9KjHrjFWngJgFG8h7XMSWsqH55hBlryutmq?modal\\_id=7306824293789207843](https://www.douyin.com/user/MS4wLjABAAAfv567McP9KjHrjFWngJgFG8h7XMSWsqH55hBlryutmq?modal_id=7306824293789207843)



## 14.Performance

Benchmark	Score	Benchmark	Score
3Dmark13	FS:9361	Cuda	
	FSE:4409		
	FSU:2138		
3Dmark11	E14916	single kernels	2306.53 / 91.1071
	P10889		
	X4065		
3Dmark Vantage	39812	N=10 w/o streams	2588.46 / 91.3833
Heaven	1323	N=10 with streams	2564.41 / 91.6849
鲁大师	111895	N=10 batched	2853.39 / 91.6422
glmark2	9979		

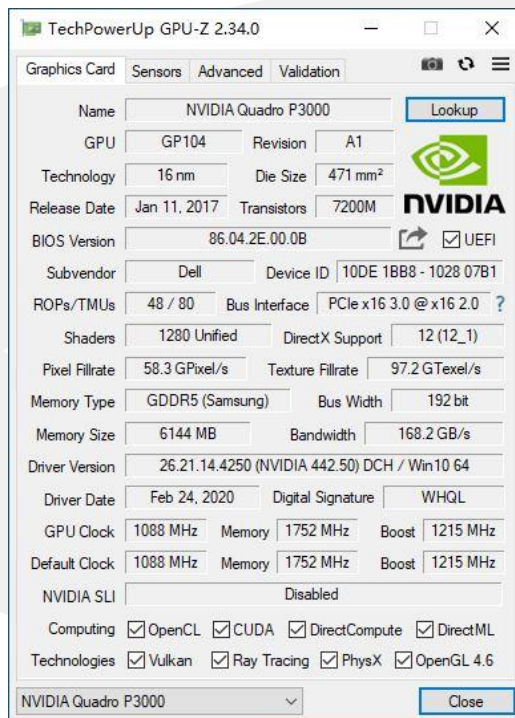

## 15.Driver

Windows 10 64bit: [https://cn.download.nvidia.com/Windows/Quadro\\_Certified/460.89/460.89-quadro-rx-desktop-notebook-win10-64bit-international-dch-whql.exe](https://cn.download.nvidia.com/Windows/Quadro_Certified/460.89/460.89-quadro-rx-desktop-notebook-win10-64bit-international-dch-whql.exe)

Windows 8.1 64bit: [https://cn.download.nvidia.com/Windows/Quadro\\_Certified/441.66/441.66-quadro-desktop-notebook-win8-win7-64bit-international-whql.exe](https://cn.download.nvidia.com/Windows/Quadro_Certified/441.66/441.66-quadro-desktop-notebook-win8-win7-64bit-international-whql.exe)

Windows 8 64bit: [https://cn.download.nvidia.com/Windows/Quadro\\_Certified/441.66/441.66-quadro-desktop-notebook-win8-win7-64bit-international-whql.exe](https://cn.download.nvidia.com/Windows/Quadro_Certified/441.66/441.66-quadro-desktop-notebook-win8-win7-64bit-international-whql.exe)

Windows 7 64bit: [https://cn.download.nvidia.com/Windows/Quadro\\_Certified/441.66/441.66-quadro-desktop-notebook-win8-win7-64bit-international-whql.exe](https://cn.download.nvidia.com/Windows/Quadro_Certified/441.66/441.66-quadro-desktop-notebook-win8-win7-64bit-international-whql.exe)

Linux 64bit: [https://cn.download.nvidia.com/XFree86/Linux-x86\\_64/450.80.02/NVIDIA-Linux-x86\\_64-450.80.02.run](https://cn.download.nvidia.com/XFree86/Linux-x86_64/450.80.02/NVIDIA-Linux-x86_64-450.80.02.run)

The latest driver or the driver cannot be downloaded here, please log on the official website to download: <https://www.nvidia.cn/geforce/drivers/>

Uninstall Driver Video: [https://www.douyin.com/user/MS4wLjABAAAfV567McP9KjHrjFWngJgFG8h7XMSWsqH55hBlryutmg?modal\\_id=7321980490926279951](https://www.douyin.com/user/MS4wLjABAAAfV567McP9KjHrjFWngJgFG8h7XMSWsqH55hBlryutmg?modal_id=7321980490926279951)

## 16.Dimensions

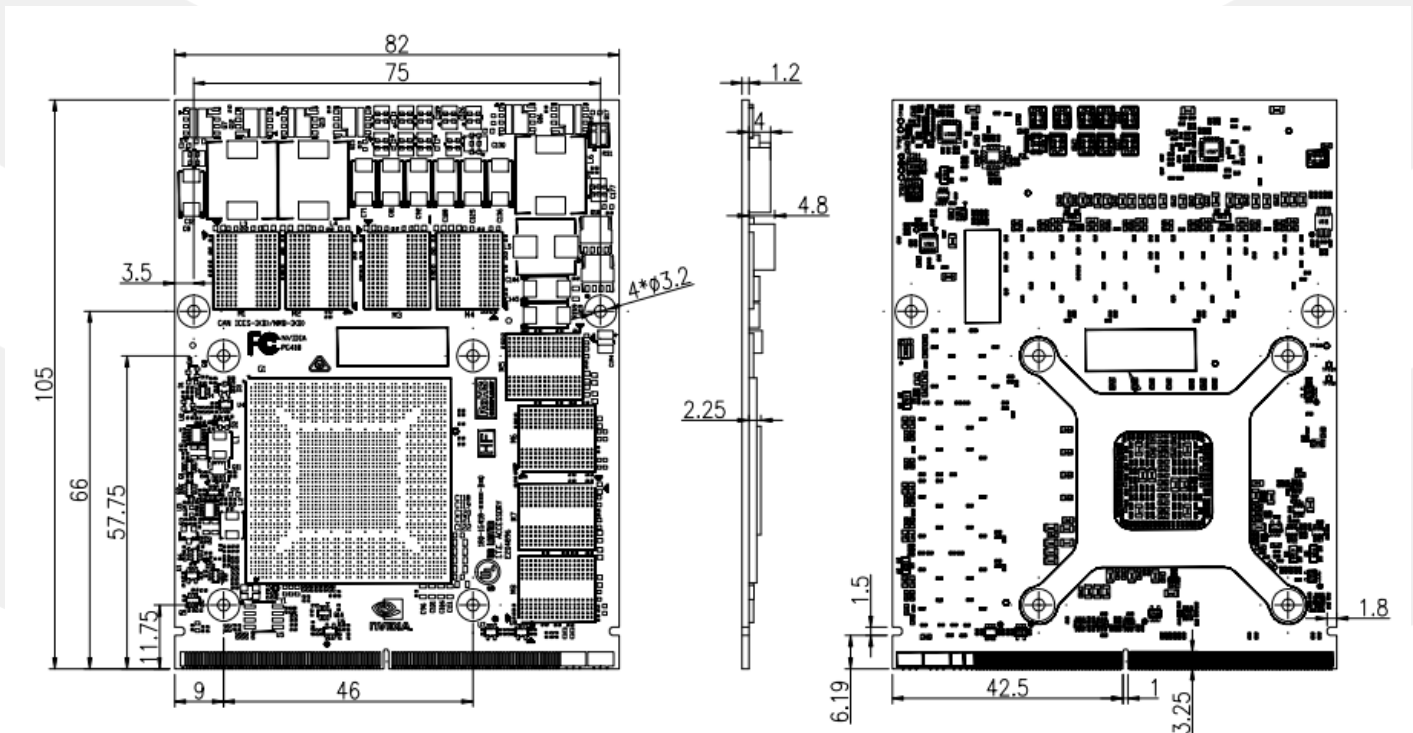

## 17.Photo

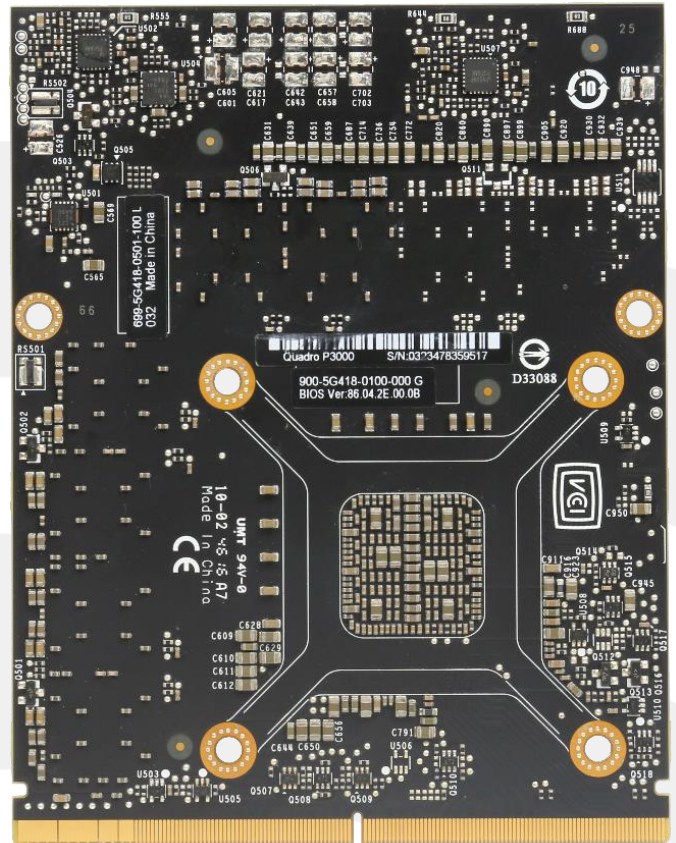
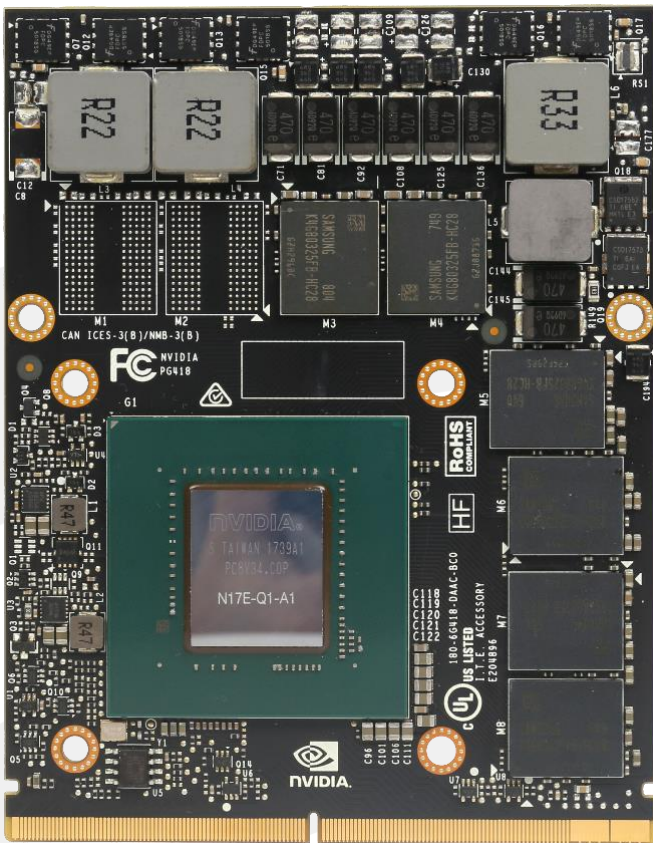

## 18.Cooling Option

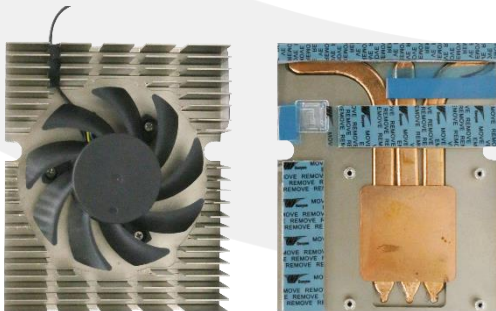

### 1.ZRT.48-6273-00-A00

<b>Dimension</b>	96*80.2*25.05mm
<b>Rated Speed</b>	4500
<b>Out of Frame Lead Wires</b>	200mm
<b>Connector</b>	4Pin 1.25

## 19.Question

故障	排除
不开机	1、更改 pgood 信号。(部份主板) 2、确认 PCIE 复位信号。 3、主板 BIOS 更改为 UEFI BIOS。
不显示	<b>Windows 10:</b> (需 1809 版本之后) 在主板 BIOS 下, 将 CSM 中 CSM Support 设置由 Enabled 更改为 Disabled。 <b>Windows7:</b> 在主板 BIOS 下, 将 CSM 中 CSM Support 设置由 Enabled 更改为 Disabled, 并将 Video 设置由 legacy 更改为 UEFI。

故障	排除
设备管理员出现惊叹号	1、原系统显卡驱动删除干净。(请使用 Display Driver Uninstaller 删除, <a href="https://www.wagnardsoft.com/">https://www.wagnardsoft.com/</a> ) 2、Windows 10 版本 16299 不支持, 需更新至最新版 (17763、17134 均可)。 3、Windows 7 打补丁 KB2685811。 4、确认核显驱动是否已安装。(不需独立显卡显示)
显卡不工作	量下 3V3/5V/2V/Reset 信号是否有电/短路? 若有电, 显卡就会工作。
不显示 (HDMI 输出)	1、4K 60Hz 显示屏, 确认 HDMI 线材是否为 HDMI2.0。 2、将显示器分辨率降为 2K 60Hz。
安装 Linux 系统, 图形界面异常/无限循环登陆界面, 无法登录系统	装驱动的时, 加上--no-opengl-files。 (禁用 opengl, 若系统上有用到这套组件, 将无法使用)
显卡无法辨视	检查 PCIE LANE Numbering Reversal 设置。 主要关注下上电和 pcie, 确认下 1、PCIE 的连接 (是否 0-15 反、差分正负反、x16 是否拆分, bios 可修改, 软硬件要一致), 耦合电容是否少以及容值; 协议兼容性 (降 gen1, 或用 x1 试试, 显卡都能支持 x1) 2、信号质量, 100MHz clk (示波器看下抖动, bios 是否有展频), pcie 的信号质量 (看实际距离不长, 概率不大, 可以 bios 调不同的去加重、预加重值试试, 能测试眼图最好) 3、上电主要是给显卡的 enable 信号, 其他的不影响开机, 时序 (主板启动比显卡快, bios 可以对 reset 信号延时试试)
控制面板无法正常开启	仅可在独显显示时, 才能正常开启; 若使用集显显示, 将无法正常开启。
集显及独显在 Win7 下, 无法同时开启 3D 启动	打系统补丁 (KB2685811), 解压后, 把所有文件 COPY 到 C 盘 根目录下运行 BAT 文件。
X86 在中标麒麟系统下, 显卡驱动后集显输出不能进系统	将 xorg.conf 文件内容清空。
银河麒麟系统自带的显卡驱动与显卡不兼容	先删除银河麒麟系统自带的显卡驱动, 然后再安装显卡驱动。 *删除指令 <code>sudo apt-get remove nvidia*</code>

## 20.Part Number

Model	Part Number	Specification
MMP3000B5-6G	8.ZRT.80-8212-04-LFF	F83 P3000m 6G 192bit GDDR5 256*32 4DP MXM Type B-工包六十入

21.Label



深圳智锐通科技有限公司  
Shenzhen Zrt Co., Ltd.



智锐通公众号

&



智锐通抖音号

- 集团总部：深圳市宝安区碧桂园凤凰智谷A栋21楼
- 北京分公司：北京市昌平区科兴西路106号院2号楼5层
- 南京分公司：南京市江宁区万科都荟天地B2栋7楼
- 苏州分公司：苏州市虎丘区港龙城市广场4栋13楼
- 成都分公司：成都市武侯区世纪百合尚寓3栋10楼
- 400-838-6869