



# MM3060B6-12G V2

MXM 显卡

USER Manual V2.0

## USER MANUAL

## 用户手册

## 声明

本使用说明书内容如有变更，恕不另行通知。本公司并不对本使用说明书之适用性，适合做某种特殊用途之使用或其他任何事项做任何明示，或做其他形式之保证或担保。因此本公司将不对手册内容之错误，或因增减展示或以其他方法使用本手册所造成之直接，间接，突发性过、或继发性之损害负任何责任。

版权声明：

版权所有----深圳智锐通科技有限公司。未经本公司许可或依著作权法之规定许准，不得复制，节录和翻译使用说明书之任何内容。

## 安全须知

1	产品使用前，务必仔细阅读产品说明书。
2	对未准备安装的板卡，应将其保存在防静电保护袋中。
3	在从包装袋中拿板卡前，应将手先置于接地金属物体上一会儿，以释放身体及手中的静电。
4	在拿板卡时，需佩带静电保护手套，并且应该养成只触及边缘部份的习惯。
5	主板与电源连接时，请确认电源电压。
6	为避免人本被电击或产品被损坏，在每次对主板、板卡进行拔插或生新配置时须先关闭交流电源或将交流电源线从电源插座中拔掉。
7	在对板卡进行搬动前，先将交流电源线从电源插座中拔掉。
8	当您需连接或拔除任何设备前，须确定所有的电源线事先已被拔掉。
9	为避免频繁开关机对产品造成不必要的损伤,关机后,应至少等待30秒后再开机。
10	设备在使用过程时出现异常情况，请找专业人员处理。

# 目录

1.Specifications.....	5
2.Block Diagram .....	7
3.Connector Pinout .....	8
4.MXM Connector .....	10
5.Power Group.....	10
6.Power Sequencing .....	11
7.Module Power Down and Power Up.....	11
8.Reset Requirements .....	12
9.DisplayPort Interface.....	12
10.DVI/HDMI on DP Interface .....	13
11. Remote Temperature.....	14
12.Thermal .....	15
13.Install Video .....	16
14.Driver.....	16
15.Performance .....	17
16.Dimensions .....	18
17.Photo.....	18
18.Cooling Option .....	19
19.Question.....	19
20.Part Number .....	21
21.Label .....	21
22.Motherboard .....	22

## 1.Specifications

Model	MM3060B6-12G V2
<b>GPU Architecture</b>	NVIDIA Ampere
<b>Graphics Processing Unit</b>	NVIDIA GeForce RTX3060 Mobility
<b>Bus Type</b>	MXM3 .1/up to PCI Express 4.0 x16
<b>Graphics Clock</b>	900MHz/1425MHz(Boost)
<b>Memory Size</b>	12G 192bit GDDR6
<b>Memory Clock</b>	1750MHz(14.0Gbps)
<b>Memory Bandwidth</b>	336.0GB/s
<b>Display Features</b>	DP_A: Display Port1.4++ DP_B: Display Port1.4++ DP_C: HDMI2.1 DP_D: Display Port1.4++
<b>Single Max Resolution</b>	DP:7680*4320@120Hz HDMI: 7680*4320@60Hz
<b>Number of Output Channel</b>	4
<b>Board Power</b>	100W(Option 75W)
<b>Board Dimensions</b>	MXM Graphics Module Version 3.1 Type B(105*82mm)
<b>Operation System</b>	Windows 11 · Windows 10/7 64bit · Linux
<b>VIN Range</b>	DC 12~19V, 3.3V&5V+/-5%
<b>Operating Temperature</b>	0~45°C(Option -20°C)
<b>Storage Temperature</b>	-20~75°C
<b>Operating Humidity</b>	0~95%(non-condensing)
<b>Storage Humidity</b>	10~90%

Render Config	
<b>Shader Processing Units</b>	3840
<b>Tensor Core</b>	120
<b>RT Core</b>	30
<b>TMUs</b>	120
<b>ROPs</b>	48
<b>SM Count</b>	30
<b>L1 Cache</b>	128KB(per SM)
<b>L2 Cache</b>	3MB

Theoretical Performance	
Pixel Rate	12361GFLOPS
Texture Rate	241.8GFLOPS
Single Precision FLOPS(AIDA64)	12361GFLOPS
Double Precision FLOPS(AIDA64)	241.8GFLOPS

Graphics Features	
DirectX	12 Ultimate(12_2)
OpenGL	4.6
OpenCL	3.0
Vulkan	1.3
Shader Model	6.7
CUDA	8.6
Video Playback	H.265, VC1, MPEG2 1080P

Surround(Landscape)	Surround(Portrait)
1*2(3840*1080@60Hz)	1*2(2160*1920@60Hz)
2*1(1920*2160@60Hz)	2*1(1080*3840@60Hz)
1*3(5760*1080@60Hz)	1*3(3240*1920@60Hz)
3*1(1920*3240@60Hz)	3*1(1080*5760@60Hz)
1*4(7680*1080@60Hz)	1*4(4320*1920@60Hz)
4*1(1920*4320@60Hz)	4*1(1080*7680@60Hz)
2*2(3840*2160@60Hz)	2*2(2160*3840@60Hz)

*\*Total resolution based on every display resolution is 1920\*1080@60Hz.*

## 2. Block Diagram

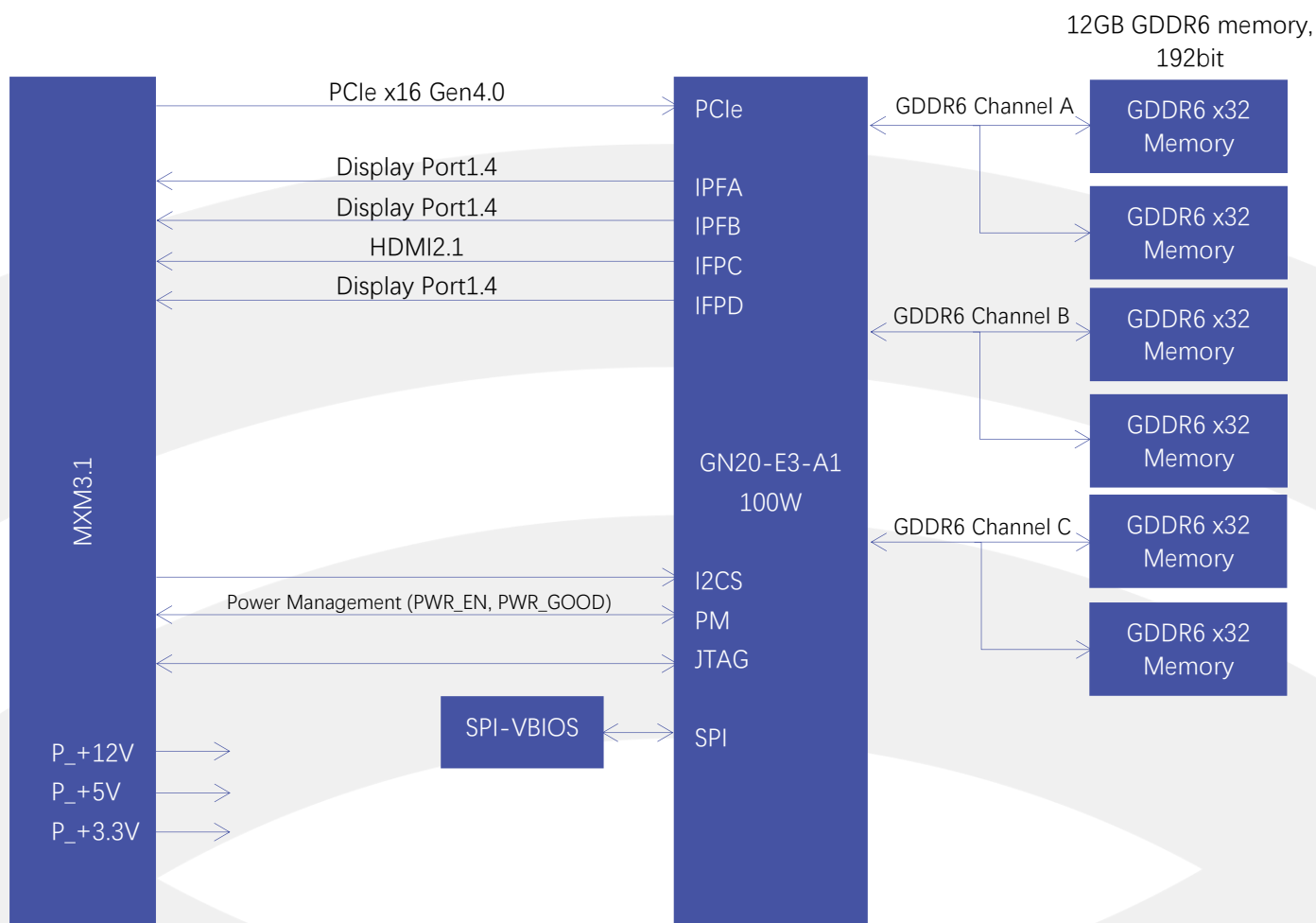

Motherboard Design Note: <https://drive.weixin.qq.com/s?k=AAAADgeKABAfINJTZm>

### 3.Connector Pinout

Table 3.1 and Table 3.2 list the connector pinout.

Table 3.1 Connector Pinout

Pin	Signal Name	Pin	Signal Name	Pin	Signal Name	Pin	Signal Name
E1	PWR_SRC	E2	PWR_SRC	69	PEX_RX12	70	GND
E3	GND	E4	GND	71	GND	72	PEX_TX11#
1	5V	2	PRSNT_R#	73	PEX_RX11#	74	PEX_TX11
3	5V	4	WAKE#	75	PEX_RX11	76	GND
5	5V	6	PWR_GOOD	77	GND	78	PEX_TX10#
7	5V	8	PWR_EN	79	PEX_RX10#	80	PEX_TX10
9	5V	10	27MHZ_REF	81	PEX_RX10	82	GND
11	GND	12	GND	83	GND	84	PEX_TX9#
13	GND	14	LVDS_U_HPD	85	PEX_RX9#	86	PEX_TX9
15	GND	16	JTAG_TESTEN	87	PEX_RX9	88	GND
17	GND	18	PWR_LEVEL	89	GND	90	PEX_TX8#
19	PEX_STD_SW#	20	TH_OVERT#	91	PEX_RX8#	92	PEX_TX8
21	VGA_DISABLE #	22	TH_ALERT#	93	PEX_RX8	94	GND
23	N/A	24	TH_PWM	95	GND	96	PEX_TX7#
25	N/A	26	GPIO0	97	PEX_RX7#	98	PEX_TX7
27	N/A	28	GPIO1	99	PEX_RX7	100	GND
29	HDMI_CEC	30	GPIO2	101	GND	102	PEX_TX6#
31	LVDS_L_HPD	32	SMB_DAT	103	PEX_RX6#	104	PEX_TX6
33	LVDS_DDC_D AT	34	SMB_CLK	105	PEX_RX6	106	GND
35	LVDS_DDC_CL K	36	GND	107	GND	108	PEX_TX5#
37	GND	38	OEM0	109	PEX_RX5#	110	PEX_TX5
39	OEM1	40	OEM2	111	PEX_RX5	112	GND
41	OEM3	42	OEM4	113	GND	114	PEX_TX4#
43	OEM5	44	OEM6	115	PEX_RX4#	116	PEX_TX4
45	OEM7	46	GND	117	PEX_RX4	118	GND
47	GND	48	PEX_TX15#	119	GND	120	PEX_TX3#
49	PEX_RX15#	50	PEX_TX15	121	PEX_RX3#	122	PEX_TX3
51	PEX_RX15	52	GND	123	PEX_RX3	124	GND
53	GND	54	PEX_TX14#	125	GND	126	KEY
55	PEX_RX14#	56	PEX_TX14	127	KEY	128	KEY
57	PEX_RX14	58	GND	129	KEY	130	KEY
59	GND	60	PEX_TX13#	131	KEY	132	KEY
61	PEX_RX13#	62	PEX_TX13	133	GND	134	GND
63	PEX_RX13	64	GND	135	PEX_RX2#	136	PEX_TX2#
65	GND	66	PEX_TX12#	137	PEX_RX2	138	PEX_TX2
67	PEX_RX12#	68	PEX_TX12	139	GND	140	GND

Table 3.2 Connector Pinout(continued)

Pin	Signal Name	Pin	Signal Name	Pin	Signal Name	Pin	Signal Name
141	PEX_RX1#	142	PEX_TX1#	213	DP_C_L2	214	DP_D_L1
143	PEX_RX1	144	PEX_TX1	215	GND	216	GND
145	GND	146	GND	217	DP_C_L3#	218	DP_D_L2#
147	PEX_RX0#	148	PEX_TX0#	219	DP_C_L3	220	DP_D_L2
149	PEX_RX0	150	PEX_TX0	221	GND	222	GND
151	GND	152	GND	223	DP_C_AUX#	224	DP_D_L3#
153	PEX_REFCLK#	154	PEX_CLK_REQ#	225	DP_C_AUX	226	DP_D_L3
155	PEX_REFCLK	156	PEX_RST#	227	RSVD	228	GND
157	GND	158	VGA_DDC_DATA	229	RSVD	230	DP_D_AUX#
159	JTAG_TDO	160	VGA_DDC_CLOCK	231	RSVD	232	DP_D_AUX
161	JTAG_TDI	162	VGA_VSYNC	233	RSVD	234	DP_C_HPD
163	JTAG_TCLK	164	VGA_HSYNC	235	RSVD	236	DP_D_HPD
165	JTAG_TMS	166	GND	237	RSVD	238	RSVD
167	JTAG_TRST#	168	VGA_RED	239	RSVD	240	3V3
169	LVDS_UCLK#	170	VGA_GREEN	241	RSVD	242	3V3
171	LVDS_UCLK	172	VGA_BLUE	243	RSVD	244	GND
173	GND	174	GND	245	RSVD	246	DP_B_L0#
175	LVDS_UTX3#	176	LVDS_LCLK#	247	RSVD	248	DP_B_L0
177	LVDS_UTX3	178	LVDS_LCLK	249	RSVD	250	GND
179	GND	180	GND	251	GND	252	DP_B_L1#
181	LVDS_UTX2#	182	LVDS_LTX3#	253	DP_A_L0#	254	DP_B_L1
183	LVDS_UTX2	184	LVDS_LTX3	255	DP_A_L0	256	GND
185	GND	186	GND	257	GND	258	DP_B_L2#
187	LVDS_UTX1#	188	LVDS_LTX2#	259	DP_A_L1#	260	DP_B_L2
189	LVDS_UTX1	190	LVDS_LTX2	261	DP_A_L1	262	GND
191	GND	192	GND	263	GND	264	DP_B_L3#
193	LVDS_UTX0#	194	LVDS_LTX1#	265	DP_A_L2#	266	DP_B_L3
195	LVDS_UTX0	196	LVDS_LTX1	267	DP_A_L2	268	GND
197	GND	198	GND	269	GND	270	DP_B_AUX#
199	DP_C_L0#	200	LVDS_LTX0#	271	DP_A_L3#	272	DP_B_AUX
201	DP_C_L0	202	LVDS_LTX0	273	DP_A_L3	274	DP_B_HPD
203	GND	204	GND	275	GND	276	DP_A_HPD
205	DP_C_L1#	206	DP_D_L0#	277	DP_A_AUX#	278	3V3
207	DP_C_L1	208	DP_D_L0	279	DP_A_AUX	280	3V3
209	GND	210	GND	281	PRSNT_L#	-	
211	DP_C_L2#	212	DP_D_L1#				

## 4.MXM Connector

Figure 4.1 MXM Connector (Card Top)

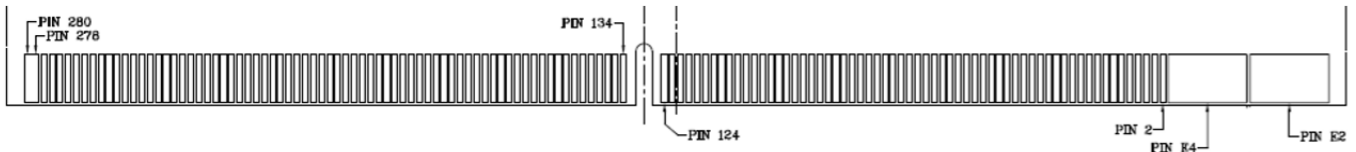
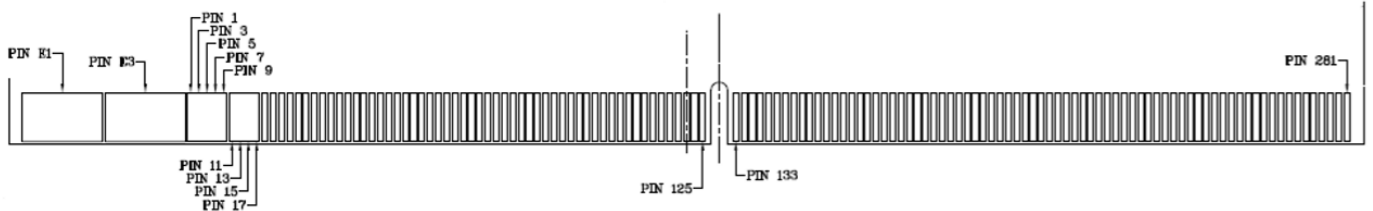

Figure 4.2 MXM Connector (Card Bottom)



## 5.Power Group

Table 5.1 shows the MXM module power requirements. The voltage tolerances in the table are specified as measured on module edge finger. The system must be able to supply the full specified current on rails(except PWR\_SRC) at all times. Th current capability of the PWR\_SRC rail must be defined by the system in the MXM system information structure.

Table 5.1 MXM Power Rails

Signal Name	I/O	Type	Impedance	Voltage	Current
PWR_SRC	I	Power	N/A	12-19V	up to 10A
5V	I	Power	N/A	5.0V±6%	2.5A
3.3V	I	Power	N/A	3.3V±6%	2.0A

*Note: PWR\_SRC voltage range is assumed to be DC or RMS. However under any circumstances the maximum peak voltage shall not exceed 22V and minimum voltage shall not fall below 6.5V.*

## 6. Power Sequencing

There is no power sequencing requirement for the input voltages to the MXM module. However the PWR\_EN signal may be asserted only after all power rails are within specified tolerance. The state of PWR\_GOOD is undefined until all rails are fully ramped. Refer to Figure 6.1 for details.

Figure 6.1 Power Sequencing

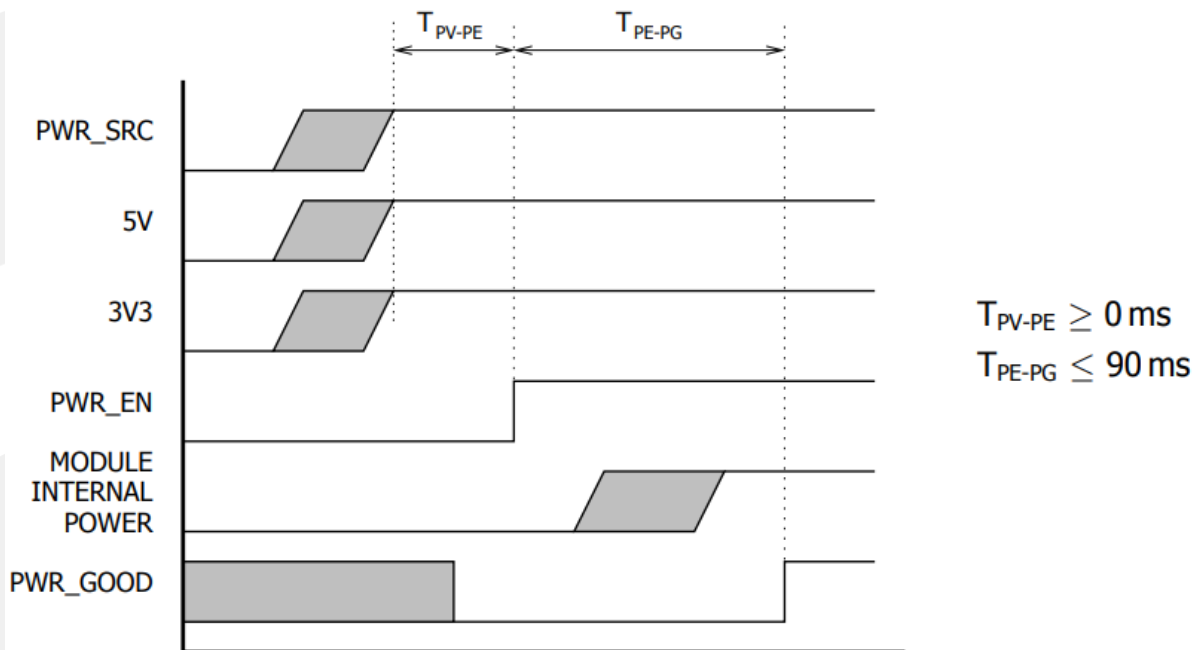

## 7. Module Power Down and Power Up

The MXM module may be powered down using the PWR\_EN signal. The system designer may choose to shut down or keep the input power while the module is powered down. Refer to Figure 7.1 for details.

Figure 7.1 Module Power Down

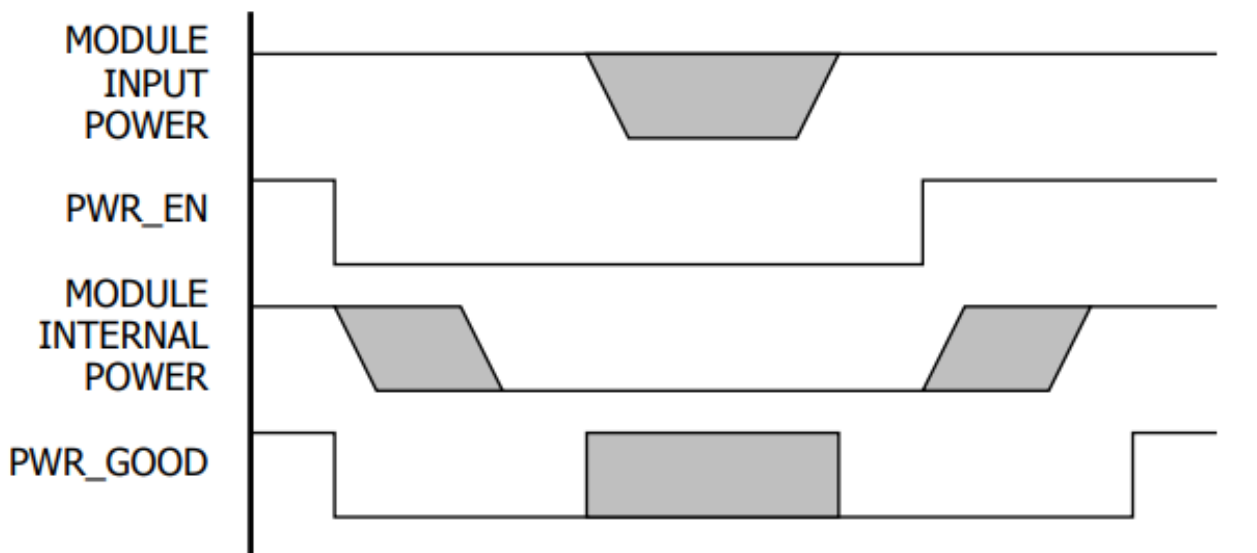

### 8.Reset Requirements

System reset may be deasserted only after the assertion of the PWR\_GOOD signal. Figure 8.1 shows the reset requirements relative to the PWR\_EN and PWR\_GOOD signals. This sequence must be followed on initial power on, system reset and resume from suspend/hibernate.

Figure 8.1 Reset Sequencing

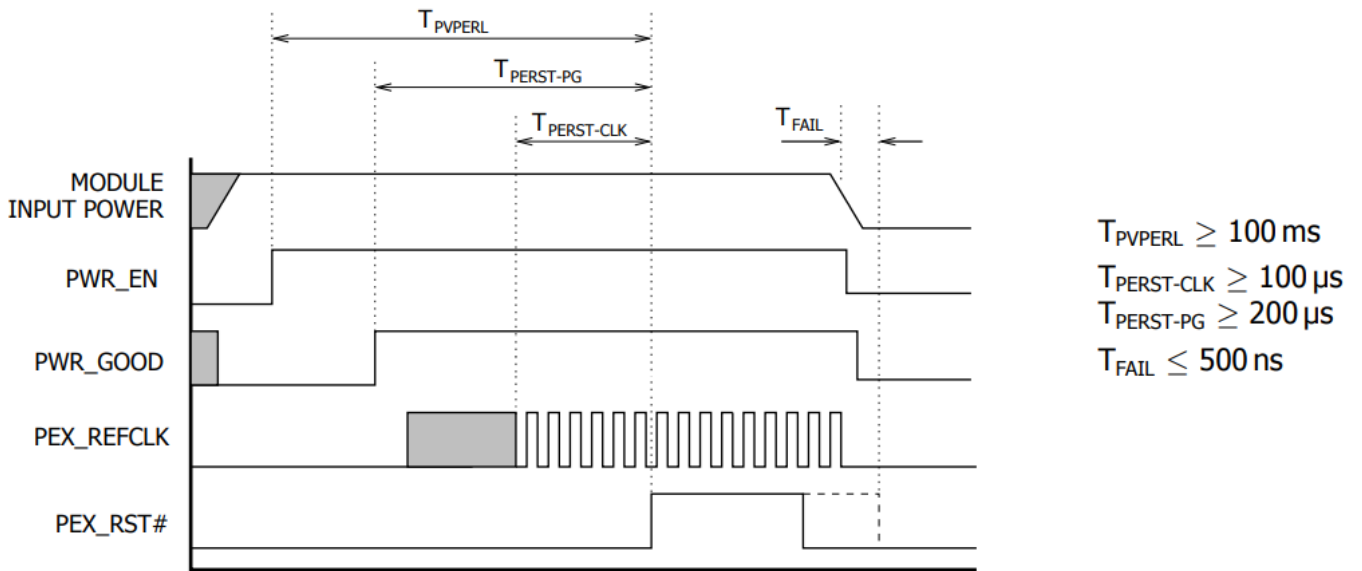

### 9.DisplayPort Interface

DC blocking capacitors of DisplayPort must be placed on the system board. In addition to the MXM implementation of Dual-mode DisplayPort requires the circuit in Figure 9.1 on the AUX lines for proper dongle detection. The HPD signal conditioning must also be placed on the system board.

Figure 9.1 Dual-mode DisplayPort Implementation

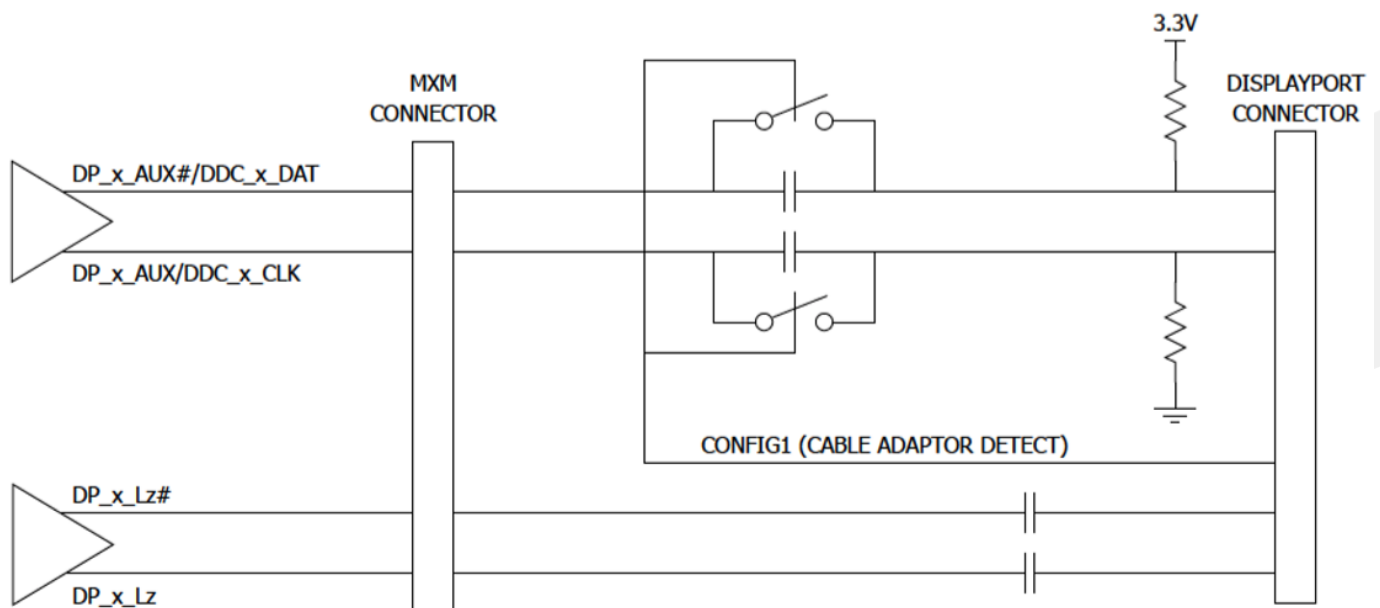

## 10.DVI/HDMI on DP Interface

Native DVI or HDMI connector support can be implemented using a DisplayPort interface. Additional circuitry is required on the system and the proper signal mapping must be observed. As Figure 10.1 shows,  $499\Omega$  1% pull-down resistors to ground on the DP lane signals must be placed on the connector side of AC coupling capacitors gated by a FET to limit the leakage. Additionally level shifting circuits must also be implemented on DDC Data and Clock.

Table 10.1 shows the mapping to connect the signals from the MXM connector to the HDMI/DVI connector.

Table 10.1 DisplayPort Multiplexed Signal Definition

Pin Name	DVI/HDMI
DP_xL0	TX_x_D2
DP_xL0#	TX_x_D2#
DP_x_L1	TX_x_D1
DP_x_L1#	TX_x_D1#
DP_x_L2	TX_x_D0
DP_x_L2#	TX_x_D0#
DP_x_L3	TX_x_CLK
DP_x_L3#	TX_x_CLK#
DP_x_AUX	DDC_x_CLK
DP_x_AUX#	DDC_x_DAT

Figure 10.1 DVI/HDMI Implementation Using DP Interface

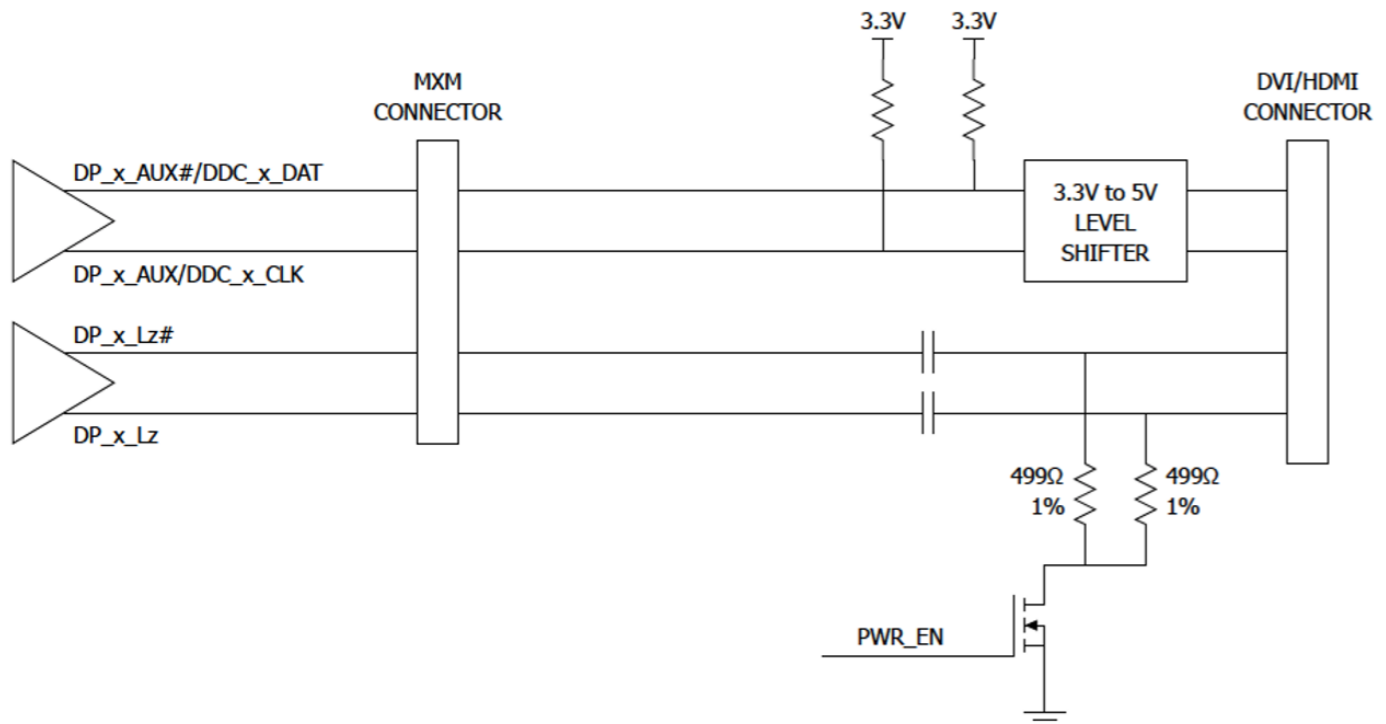

## 11. Remote Temperature

The TMP451 device has a device address of 4Ch(1001 100b).

Remote Temperature High Byte Register (offset: Read = 01h; Write = N/A) [reset = 00h]

Figure 11.1 Remote Temperature High Byte Register

7	6	5	4	3	2	1	0
RT11	RT10	RT9	RT8	RT7	RT6	RT5	RT4
R-0h	R-0h	R-0h	R-0h	R-0h	R-0h	R-0h	R-0h

LEGEND: R/W = Read/Write; R = Read only; -n = value after reset

Table 11.1 Remote Temperature High Byte Register Field Descriptions

Bit	Field	Type	Reset	Description
7-0	RT11-RT4	R	0h	Remote temperature high byte. The resolution of the LSB in this register is 1 °C. This register is read-only and is updated by the ADC each time a temperature measurement is completed. When the full temperature value is needed, reading the high byte register first causes the low byte register value to be locked (the ADC does not write to it) until it is read. The same thing happens upon reading the low byte register value first (the high byte register value is locked until it is read). This mechanism assures that both bytes of the read operation are from the same ADC conversion. This assurance remains valid only until another register is read. For proper operation, read the high byte of the temperature result first. Read the low byte register in the next read command; if the low byte is not needed, the register may be left unread.

Manufacturer ID Register (offset: Read = FEh; Write = N/A) [reset = 55]

Figure 11.2 Manufacturer ID Register

7	6	5	4	3	2	1	0
ID7	ID6	ID5	ID4	ID3	ID2	ID1	ID0
R-0h	R-1h	R-0h	R-1h	R-0h	R-1h	R-0h	R-1h

LEGEND: R/W = Read/Write; R = Read only; -n = value after reset

Table 11.2 Manufacturer ID Register Field Descriptions

Bit	Field	Type	Reset	Description
7-0	ID7 - ID0	R	55h	Manufacturer identification information

The TMP451 device allows for the two-wire bus controller to query the device for manufacturer and device IDs to enable software identification of the device at the particular two-wire bus address. The manufacturer ID is obtained by reading from pointer address FEh. The TMP451 device reads 55h for the manufacturer code.

## 12.Thermal

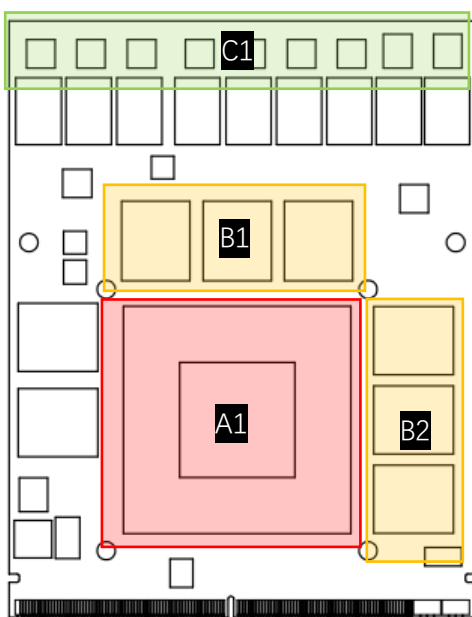

Components	Area	TDP	Height
GPU	A1	74.5W	2.8mm
Memory	B1	2W*3	0.9mm
Memory	B2	2W*3	0.9mm
Mosfet	C1	1.5W*9	0.75mm

Chipset		Specification
Dimensions		20*15*2.8mm
Stress	Maximum	75PSI
	Normal	30-40PSI

*\*Thermal Limits Rated: 83.0°C Max: 90.0°C.*

### Cooling Suggestion:

- 1、显卡建议先固定在散热器上，散热器压铆柱外径为 4mm，M2 的螺柱。
- 2、散热器的重量要用箱体来支撑固定。
- 3、显存和 MOS 要加导热垫。

### 13.Install Video

[https://www.douyin.com/user/MS4wLjABAAAfV567McP9KjHrjFWngJgFG8h7XMSWsqH55hBlryutm?modal\\_id=7306824293789207843](https://www.douyin.com/user/MS4wLjABAAAfV567McP9KjHrjFWngJgFG8h7XMSWsqH55hBlryutm?modal_id=7306824293789207843)

- 1) 作业时请戴好接地良好且紧贴皮肤的静电环或静电手套。
- 2) 检查各元件有否掉件、撞件等。
- 3) 金手指有无黏胶、脏污、印痕未清洗干净、氧化、锣槽锣偏。
- 4) 在 BGA 中间表面涂上适量均匀导热膏(导热系数 5, 建议型号: 信越 7921-5), 覆盖面积不可少於 BGA 玻璃表面 75%。

#### **注意:**

- A. 导热膏搅拌后再使用。
- B. 导热膏不可粘到其它元器件上。

- 5) 取散热器, 将散热器导热垫上的保护膜撕除干净, 导热垫上不能有杂物。
- 6) 显存及 MOS 位置上不可漏少导热垫。
- 7) 对准螺丝孔位, 使用电批将弹簧螺柱按照对角顺序拧紧到位, 不可漏锁螺丝, 螺丝不可滑牙。
- 8) 锁螺丝时, 先预锁对角两螺丝 50%, 再锁另外两对角完后, 依序将四角顺序将螺丝拧紧到位。
- 9) 检查板卡外观应良好, 无变形; 显卡芯片及散热器紧密贴合无缝隙。
- 10) 装配至主板 MXM 插槽时, 需斜度 45 度插入安装。
- 11) 装配在主板上时, 检查显卡底部与主板是否有干涉。
- 12) 板卡板边二个螺丝孔务必支撑在机箱上, 防止受力和变形。

### 14.Driver

Windows 11: <https://pan.baidu.com/s/1gRfmgXtcfWQXdESR-BZ-rQ?pwd=u10o>

Windows 10 64bit: <https://pan.baidu.com/s/1gRfmgXtcfWQXdESR-BZ-rQ?pwd=u10o>

Windows 7 64bit: <https://pan.baidu.com/s/1laoDliiTdA1fzE6uAF3M9Q?pwd=cpzz>

Linux: <https://pan.baidu.com/s/1GQpeuw81hSxCuLPLXm3U7Q?pwd=hefa>

Uninstall Driver Video: [https://www.douyin.com/user/MS4wLjABAAAfV567McP9KjHrjFWngJgFG8h7XMSWsqH55hBlryutm?modal\\_id=7321980490926279951](https://www.douyin.com/user/MS4wLjABAAAfV567McP9KjHrjFWngJgFG8h7XMSWsqH55hBlryutm?modal_id=7321980490926279951)

## 15.Performance

Benchmark	Score
3Dmark13	FS:20591
	FSE:9672
	FSU:4810
3Dmark11	E23959
	P20423
	X9363
3Dmark Vantage	74955
Heaven	3104
鲁大师	305426
glmark2	11947

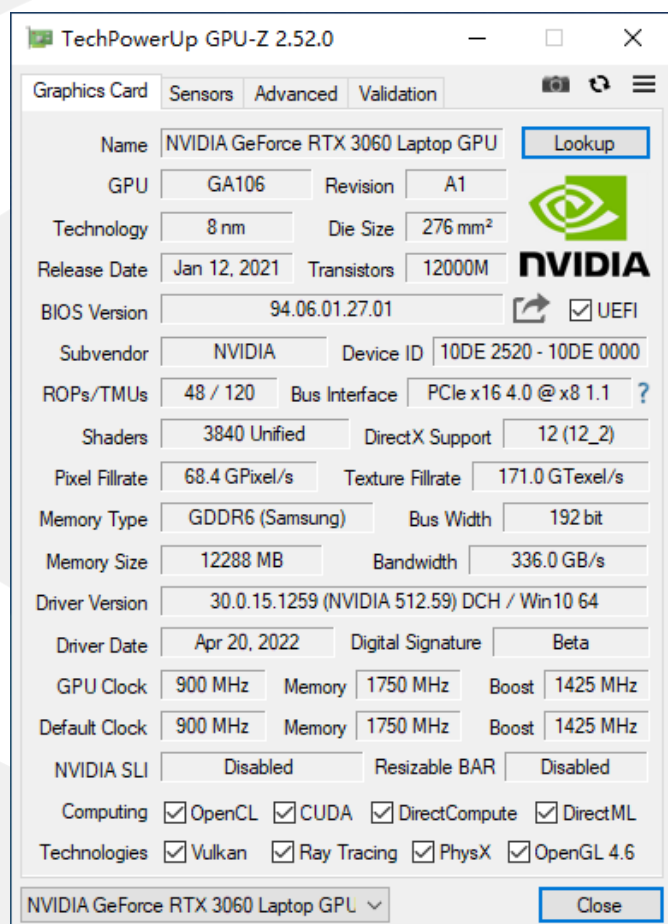

**TechPowerUp GPU-Z 2.52.0**

Graphics Card | Sensors | Advanced | Validation

Name: NVIDIA GeForce RTX 3060 Laptop GPU [Lookup]

GPU: GA106 | Revision: A1

Technology: 8 nm | Die Size: 276 mm<sup>2</sup>

Release Date: Jan 12, 2021 | Transistors: 12000M

BIOS Version: 94.06.01.27.01 [UEFI]

Subvendor: NVIDIA | Device ID: 10DE 2520 - 10DE 0000

ROPs/TMUs: 48 / 120 | Bus Interface: PCIe x16 4.0 @ x8 1.1

Shaders: 3840 Unified | DirectX Support: 12 (12\_2)

Pixel Fillrate: 68.4 GPixel/s | Texture Fillrate: 171.0 GTexel/s

Memory Type: GDDR6 (Samsung) | Bus Width: 192 bit

Memory Size: 12288 MB | Bandwidth: 336.0 GB/s

Driver Version: 30.0.15.1259 (NVIDIA 512.59) DCH / Win10 64

Driver Date: Apr 20, 2022 | Digital Signature: Beta

GPU Clock: 900 MHz | Memory: 1750 MHz | Boost: 1425 MHz

Default Clock: 900 MHz | Memory: 1750 MHz | Boost: 1425 MHz

NVIDIA SLI: Disabled | Resizable BAR: Disabled

Computing:  OpenCL  CUDA  DirectCompute  DirectML

Technologies:  Vulkan  Ray Tracing  PhysX  OpenGL 4.6

NVIDIA GeForce RTX 3060 Laptop GPU [Close]

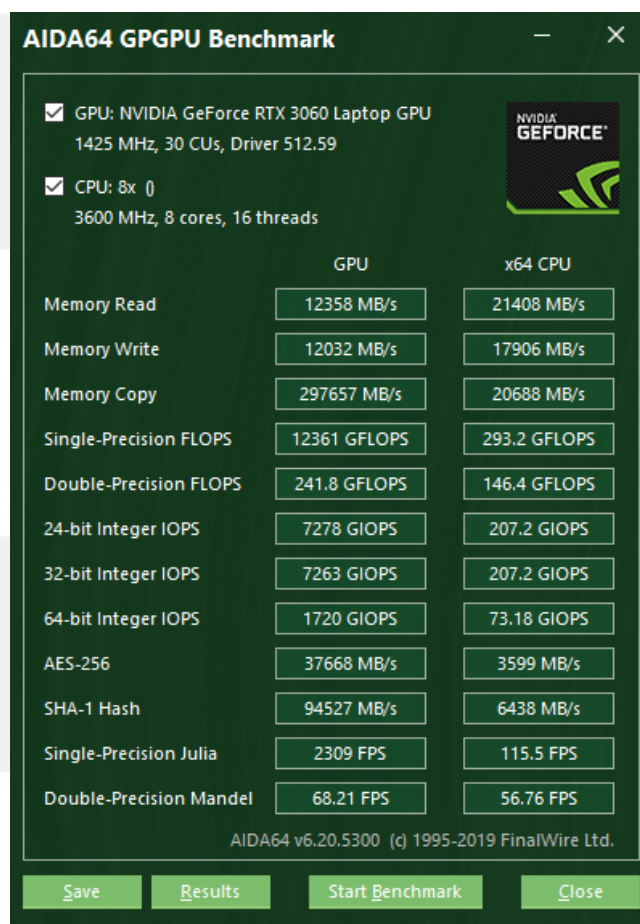

**AIDA64 GPGPU Benchmark**

GPU: NVIDIA GeForce RTX 3060 Laptop GPU  
1425 MHz, 30 CUs, Driver 512.59

CPU: 8x 0  
3600 MHz, 8 cores, 16 threads

	GPU	x64 CPU
Memory Read	12358 MB/s	21408 MB/s
Memory Write	12032 MB/s	17906 MB/s
Memory Copy	297657 MB/s	20688 MB/s
Single-Precision FLOPS	12361 GFLOPS	293.2 GFLOPS
Double-Precision FLOPS	241.8 GFLOPS	146.4 GFLOPS
24-bit Integer IOPS	7278 GIOPS	207.2 GIOPS
32-bit Integer IOPS	7263 GIOPS	207.2 GIOPS
64-bit Integer IOPS	1720 GIOPS	73.18 GIOPS
AES-256	37668 MB/s	3599 MB/s
SHA-1 Hash	94527 MB/s	6438 MB/s
Single-Precision Julia	2309 FPS	115.5 FPS
Double-Precision Mandel	68.21 FPS	56.76 FPS

AIDA64 v6.20.5300 (c) 1995-2019 FinalWire Ltd.

[Save] [Results] [Start Benchmark] [Close]

### 16.Dimensions

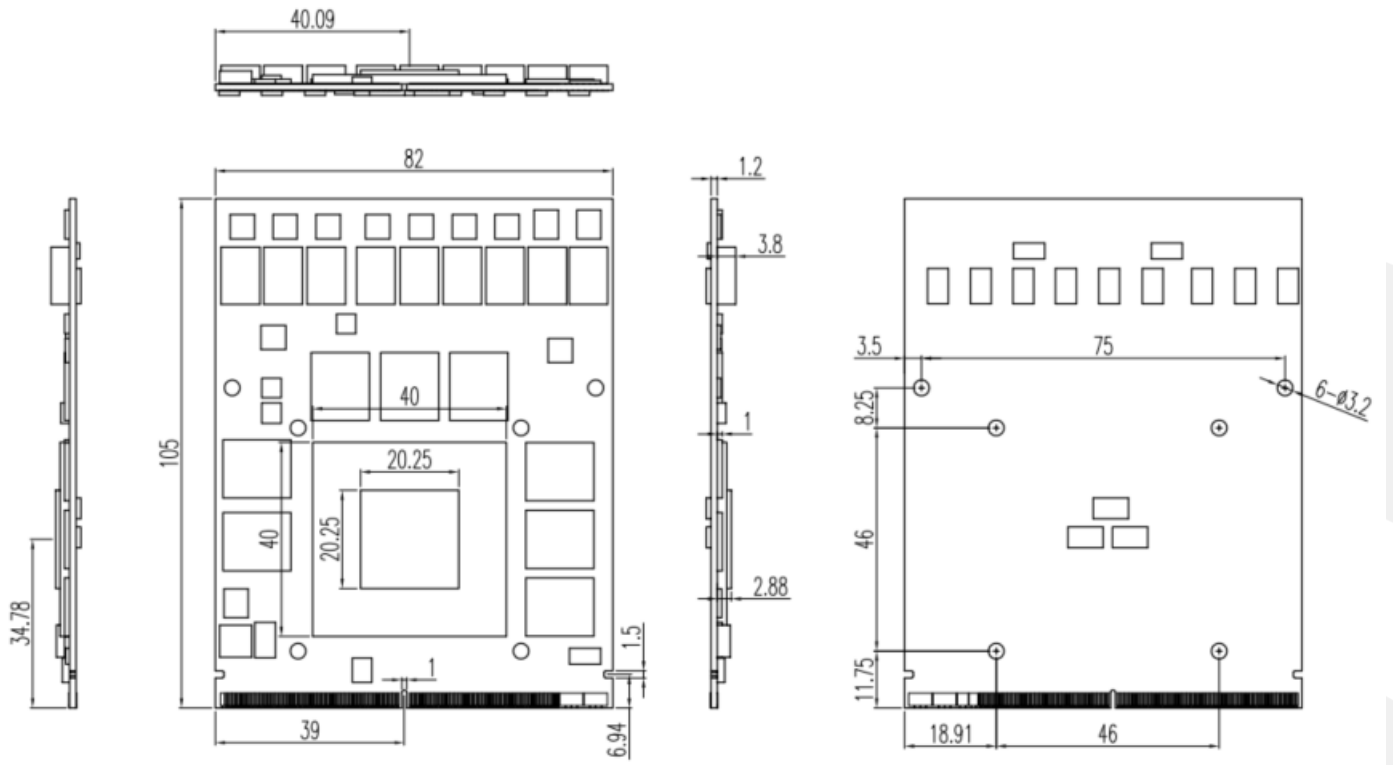

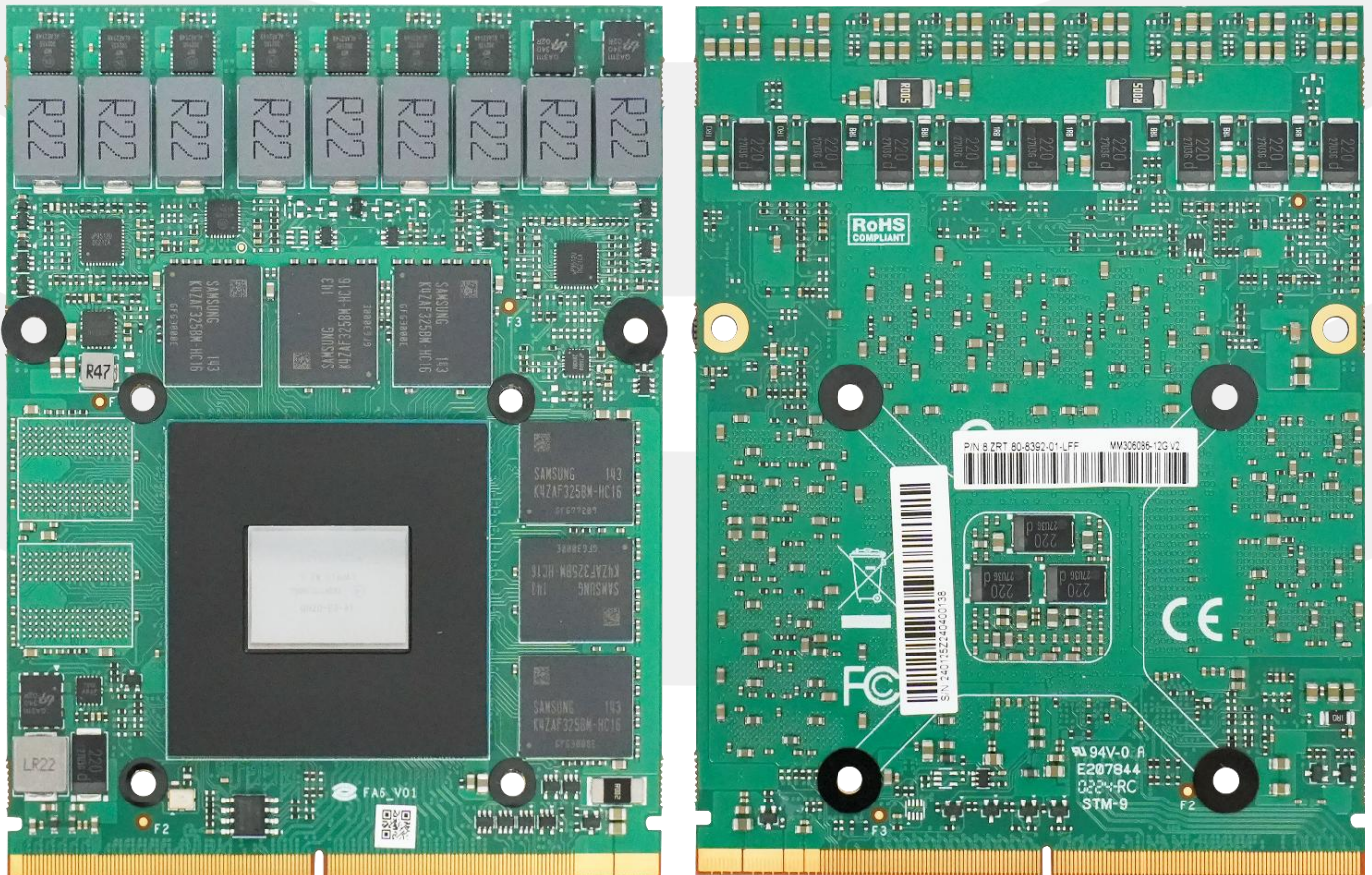

3D File: <https://drive.weixin.qq.com/s?k=AAAADgeKABAhZSuctu>

### 17.Photo

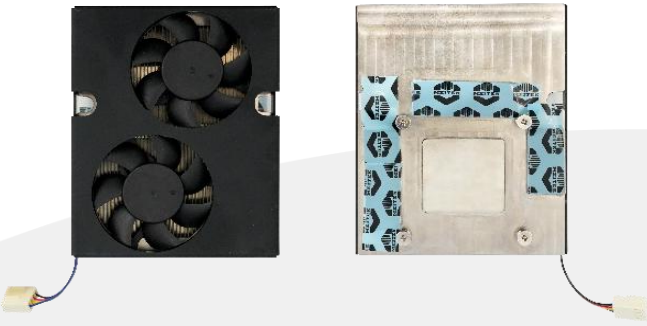
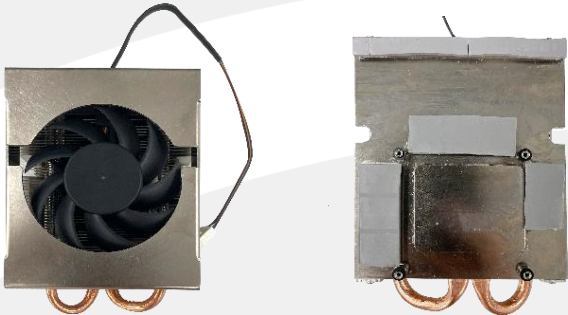

## 18.Cooling Option

	<table border="1"> <thead> <tr> <th colspan="2">1.ZRT.48-6350-00-A00(For 120W)</th> </tr> </thead> <tbody> <tr> <td>Dimension</td> <td>103*82*32mm</td> </tr> <tr> <td>Rated Speed</td> <td>8000*2</td> </tr> <tr> <td>Out of Frame Lead Wires</td> <td>200mm</td> </tr> <tr> <td>Connector</td> <td>4Pin 2.54</td> </tr> </tbody> </table>	1.ZRT.48-6350-00-A00(For 120W)		Dimension	103*82*32mm	Rated Speed	8000*2	Out of Frame Lead Wires	200mm	Connector	4Pin 2.54
1.ZRT.48-6350-00-A00(For 120W)											
Dimension	103*82*32mm										
Rated Speed	8000*2										
Out of Frame Lead Wires	200mm										
Connector	4Pin 2.54										
	<table border="1"> <thead> <tr> <th colspan="2">1.ZRT.48-6306-00-A00</th> </tr> </thead> <tbody> <tr> <td>Dimension</td> <td>113*80*45mm</td> </tr> <tr> <td>Rated Speed</td> <td>4500</td> </tr> <tr> <td>Out of Frame Lead Wires</td> <td>200mm</td> </tr> <tr> <td>Connector</td> <td>4Pin 2.54</td> </tr> </tbody> </table>	1.ZRT.48-6306-00-A00		Dimension	113*80*45mm	Rated Speed	4500	Out of Frame Lead Wires	200mm	Connector	4Pin 2.54
1.ZRT.48-6306-00-A00											
Dimension	113*80*45mm										
Rated Speed	4500										
Out of Frame Lead Wires	200mm										
Connector	4Pin 2.54										
	<table border="1"> <thead> <tr> <th colspan="2">1.ZRT.48-6349-00-A00(For 75W)</th> </tr> </thead> <tbody> <tr> <td>Dimension</td> <td>96*80.2*25mm</td> </tr> <tr> <td>Rated Speed</td> <td>4500</td> </tr> <tr> <td>Out of Frame Lead Wires</td> <td>150mm</td> </tr> <tr> <td>Connector</td> <td>4Pin 2.54</td> </tr> </tbody> </table>	1.ZRT.48-6349-00-A00(For 75W)		Dimension	96*80.2*25mm	Rated Speed	4500	Out of Frame Lead Wires	150mm	Connector	4Pin 2.54
1.ZRT.48-6349-00-A00(For 75W)											
Dimension	96*80.2*25mm										
Rated Speed	4500										
Out of Frame Lead Wires	150mm										
Connector	4Pin 2.54										

## 19.Question

故障	排除
不开机	1、更改 pgood 信号。(部份主板) 2、确认 PCIe 复位信号。 3、主板 BIOS 更改为 UEFI BIOS。
不显示	<b>Windows 10:</b> (需 1809 版本之后) 在主板 BIOS 下, 将 CSM 中 CSM Support 设置由 Enabled 更改为 Disabled。
设备管理员出现惊叹号	1、原系统显卡驱动删除干净。(请使用 Display Driver Uninstaller 删除, <a href="https://www.wagnardsoft.com/">https://www.wagnardsoft.com/</a> ) 2、Windows 10 版本 16299 不支持, 需更新至最新版(17763、17134 均可)。 3、确认核显驱动是否已安装。(不需独立显卡显示)
不显示(HDMI 输出)	1、4K 60Hz 显示屏, 确认 HDMI 线材是否为 HDMI2.0。 2、将显示器分辨率降为 2K 60Hz。
显卡不工作	量下 3V3/5V/2V/Reset 信号是否有电/短路? 若有电, 显卡就会工作。

故障	排除
控制面板无法正常开启	仅可在独显显示时，才能正常开启；若使用集显显示，将无法正常开启。
安装 Linux 系统，图形界面异常/无限循环登陆界面，无法登录系统	装驱动的时候，加上--no-opengl-files。 (禁用 opengl，若系统上有用到这套组件，将无法使用)
X86 在中标麒麟系统下，显卡驱动后集显输出不能进系统	将 xorg.conf 文件内容清空。
银河麒麟系统自带的显卡驱动与显卡不兼容	先删除银河麒麟系统自带的显卡驱动，然后再安装显卡驱动。 *删除指令 <code>sudo apt-get remove nvidia*</code>
显卡无法辨视	检查 PCIe LANE Numbering Reversal 设置。 主要关注下上电和 PCIe，确认下 1、PCIe 的连接(是否 0-15 反、差分正负反、x16 是否拆分，BIOS 可修改，软硬件要一致)，耦合电容是否少以及容值；协议兼容性(降 Gen1，或用 x1 试试，显卡都能支持 x1) 2、信号质量，100MHz clk(示波器看下抖动，BIOS 是否有展频)，PCIe 的信号质量(看实际距离不长，概率不大，可以 BIOS 调不同的去加重、预加重值试试，能测试眼图最好) 3、上电主要是给显卡的 enable 信号，其他的不影响开机，时序(主板启动比显卡快，BIOS 可以对 reset 信号延时试试)
设备管理器显示设备安装成功，但 GPU-Z 显存容量与主频显示为 0	开机时按 DEL 键进 BIOS 设置中选择 Chipset→System Agent (SA) Configuration→PCI Express Configuration→PCI Express Root Port 中的 ASPM 选着 Disabled (注：PCI Express Root port 所有选项中的 ASPM 都选着 Disabled.)
Win11 系统下安装驱动会报缺少 clb.dll 文件	clb.dll 档案拷贝放到 Win11 系统对应目录下(如下)→重启系统→再安装显卡驱动。 C:\windows\SysWOW64 --(32bit) C:\Windows\WinSxS\wow64_microsoft-windows-registry-editor_31bf3856ad364e35_10.0.19041.746_none_dc7caa836f08ad57 --(32bit) C:\windows\system32 --(64bit) C:\Windows\WinSxS\amd64_microsoft-windows-registry-editor_31bf3856ad364e35_10.0.19041.746_none_d22800313aa7eb5c --(64bit)

## 20.Part Number

Model	Part Number	Specification
MM3060B6-12G V2	8.ZRT.80-8392-01-LFF	FA6 RTX3060m 12G 192bit GDDR6 DP+DP+HDMI+DP MXM Type B 100W-ZRT 彩包二十入
MM3060B6-12G V2(75W)	8.ZRT.80-8392-00-LFF	FA6 RTX3060m 12G 192bit GDDR6 DP+DP+HDMI+DP MXM Type B 75W-ZRT 彩包三十入(Windows)
	8.ZRT.80-8392-11-LEE	FA6 RTX3060m 12G 192bit GDDR6 DP+DP+HDMI+DP MXM Type B 75W-ZRT 彩包三十入(Linux)
MM3060B6-12G V2(75W/-20)	8.ZRT.80-8392-03-LFF	FA6 RTX3060m 12G 192bit GDDR6 DP+DP+HDMI+DP MXM Type B 75W -20度-ZRT 彩包二十入

## 21.Label

Model

MM3060B6-12G V2



SN:E53080839201Z00193

P/N

Detailed description: This block shows a product label layout. At the top, the word 'Model' is written in blue. Below it, the model number 'MM3060B6-12G V2' is printed in large black font. A blue arrow points from the text 'Model' to the model number. Below the model number is a standard 1D barcode. To the right of the 1D barcode is a square QR code. Below the 1D barcode, the serial number 'SN:E53080839201Z00193' is printed. A blue arrow points from the text 'P/N' (Part Number) to the serial number.

## 22.Motherboard

Model Name	Part Number	Specification
EMA-7103	8.ZRT.80-1605-37-LEE	EMA-7103_V2.1,ITX 主板,i9-11950H,WM590,SO-DDR4*2,MXM*1,18-26v 散热器-包装,版本 V00
	8.ZRT.80-1605-43-LEE	EMA-7103_V2.1,ITX 主板,i9-11950H,WM590,SO-DDR4*2,MXM*1,18-26v,EDP 散热器-包装,版本 V00
	8.ZRT.80-1605-36-LEE	EMA-7103_V2.1,ITX 主板,i7-11850H,WM590,SO-DDR4*2,MXM*1,18-26v 散热器-包装,版本 V00
	8.ZRT.80-1605-35-LEE	EMA-7103_V2.1,ITX 主板,i5-11500H,WM590,SO-DDR4*2,MXM*1,18-26v 散热器-包装,版本 V00
EMA-7102	8.ZRT.80-6477-01-LFF	EMA-7102-01/i5-8400H 标准 7 寸主板带 MXM 显卡接口 散热器-工包十入
	8.ZRT.80-6477-02-LFF	EMA-7102-02/ i7-8850H 标准 7 寸主板带 MXM 显卡接口 散热器-工包十入
	8.ZRT.80-6477-03-LFF	EMA-7102-03/i7-9850H 标准 7 寸主板带 MXM 显卡接口 散热器-工包十入
EZT_Q370B	8.ZRT.80-6436-15-LFF	EZT_Q370B 主板( 尺寸 210*200mm) LGA1151+IT8786E-I,SODIMM DDR4*2,RJ45*2,USB2.0*4,USB3.0*6,MIC*1,LINEOUT*1,MXM3.0*1,19-24V/工包十入

深圳智锐通科技有限公司  
Shenzhen Zrt Co., Ltd.



智锐通公众号

&



智锐通抖音号

- 📍 集团总部：深圳市宝安区碧桂园凤凰智谷A栋21楼
- 📍 南京分公司：南京市江宁区万科都荟天地B2栋7楼
- ☎ 400-838-6869